

VERZE 1.2.

2024



# Panzerkampfwagen III Panzer III PzKpfw III

1:10



**UPDATE - V-1.2.**

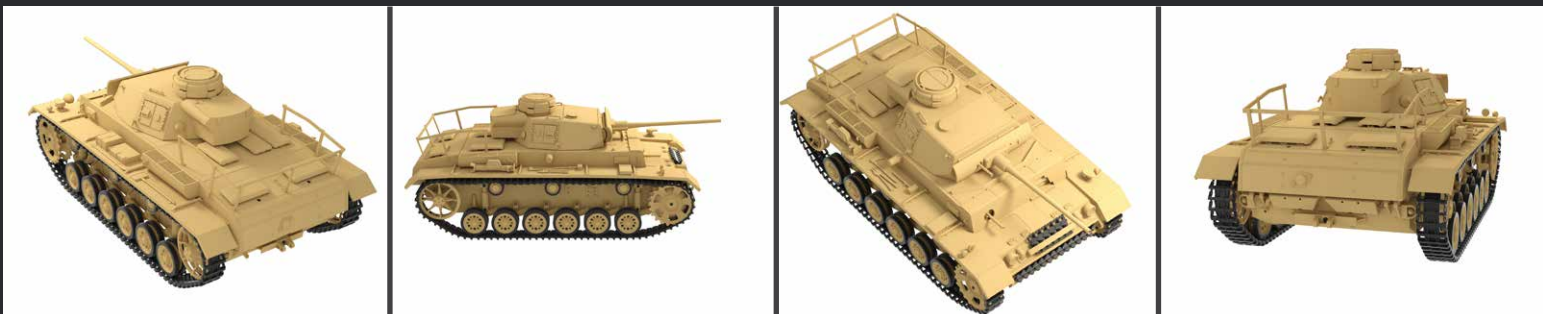

# BUILD GUIDE

[www.3dtisk.store](http://www.3dtisk.store)

# Build Guide

## 3d print

### Settings :

Print setting: 0.20mm (for connecting parts 0.15mm more accurate, e.g. inserting ball bearings)

Filament: **PLA 3 Kg**

STL files: **253 pcs**

Print duration: **9 days**

## UPDATE V-1.2.

*combined gearbox, stronger drive axle, easier assembly, replaceable parts, new belt tensioner*

## Spojovací materiál

### Screws

M3 x 16mm = 66pcs

M3 x 10mm = 8pcs

### Ball-bearing:

Ball-bearing 10 x 15 x 4mm = 20pcs

Ball-bearing 12 x 21 x 5mm = 4pcs

### 70XL Timing belt

width: 6.35 mm teeth: 35 = 4pcs

### Springs:

0,5 mm, 30 mm, 5 mm = 12pcs

**Binding wire:** tl. 1 mm

**Super glue**

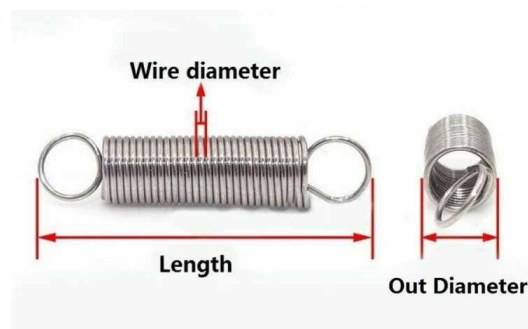

**Engines:**  
DC Engines 540

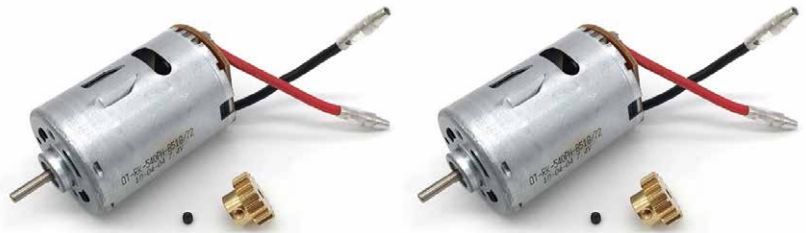

**Regulators:**  
two-way electric regulators

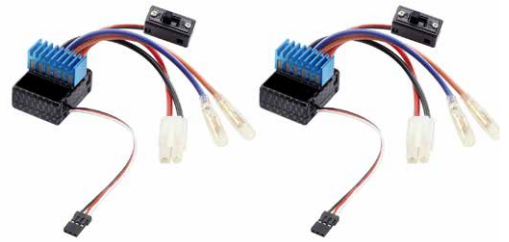

**Serve:**  
20,3x38x40,5mm



**DIAGRAM**

**TRANSMITTER - TX**

**SERVO-1**

**SERVO-2**

**RECEIVER-RX**

At least 4 channel receiver, for control  
2x Engines, 1x tower servo rotation,  
1x cannon positioning.



**ENGINES**  
DC Engines

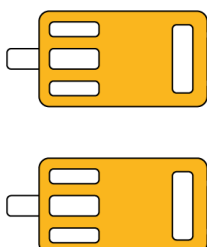

**REGULATORS**

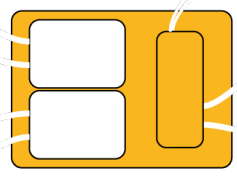

**BATTERY**  
Lipo! S2, S3



# Panzer III

## PARAMETRY MODELU

Scale:: 1:10

Dimension:: 657 x 345 x 279 mm

Weight:: 4,5 Kg



**A**

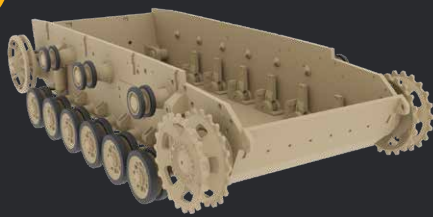

**E**



**B**



**F**

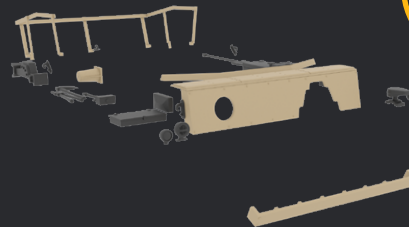

**C**



**G**

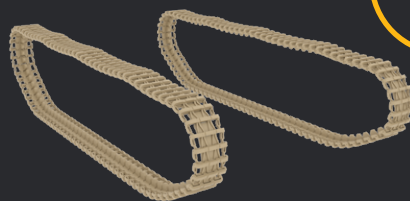

**D**

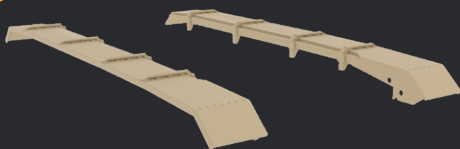

**P**



# Panzer III

A

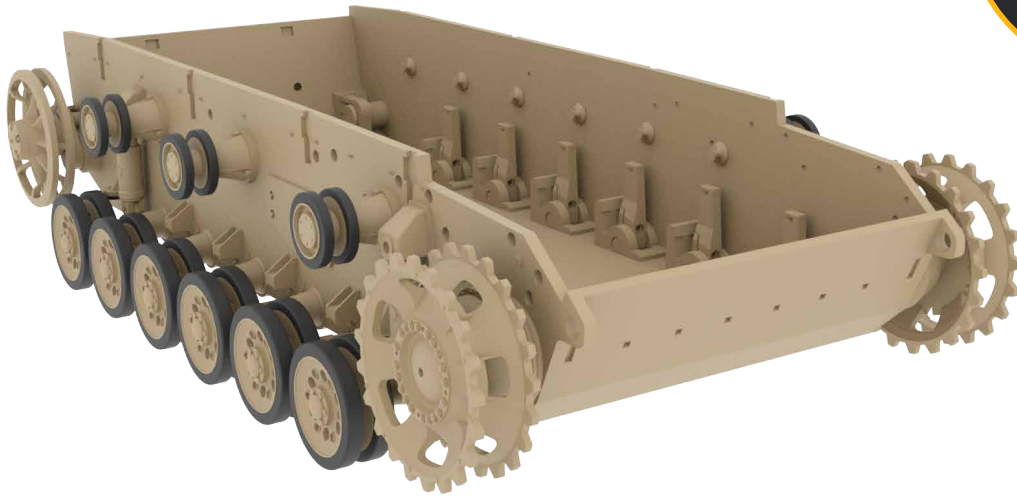

## Files:

A-1-1x

A-2-1x

A-3-1x

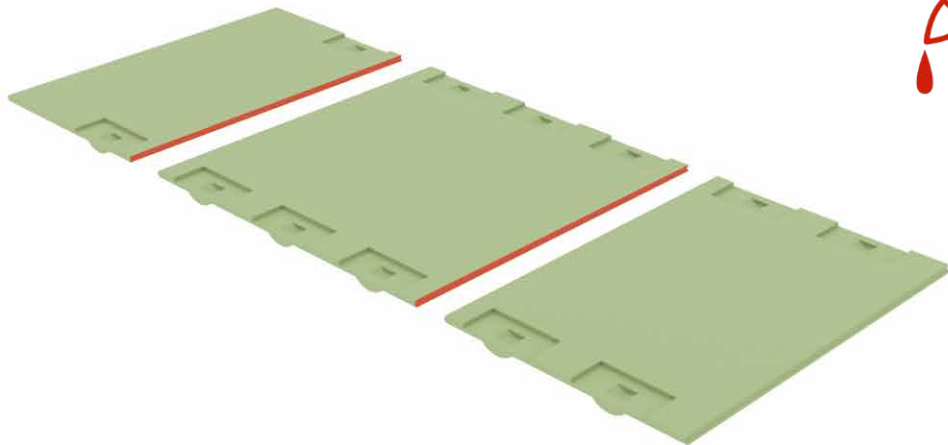

## Files:

A-4-right-6x

A-4-left-6x

A-5-right-6x

A-5-left-6x

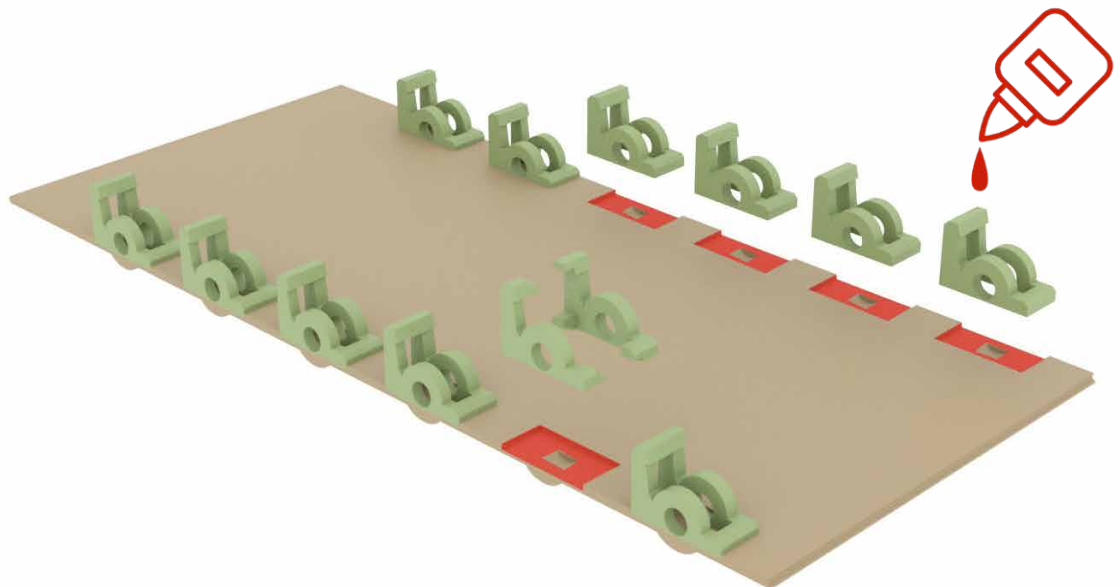

**Files:**

- A-6-right-1x
- A-6-left-1x
- A-7-right-1x
- A-7-left-1x
- A-8-right-1x
- A-8-left-1x

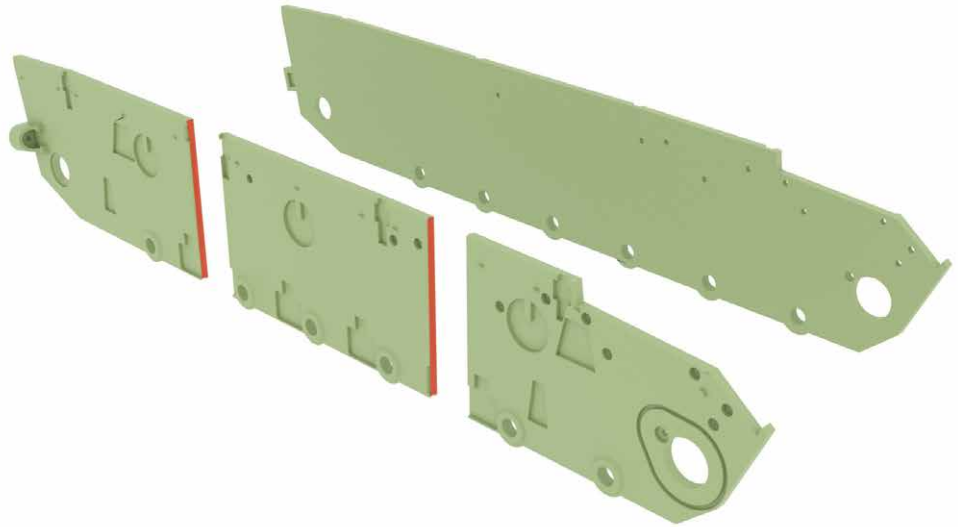

**Files:**

- A-11-1x
- A-12-left-1x
- A-12-right-1x

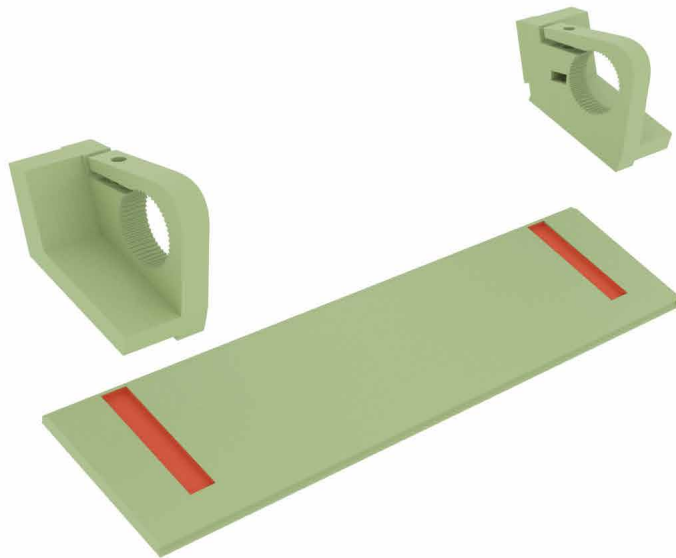

**Files:**

- A-9-1x
- A-10-1x
- A-11-1x
- A-12-left-1x
- A-12-right-1x
- A-13-1x

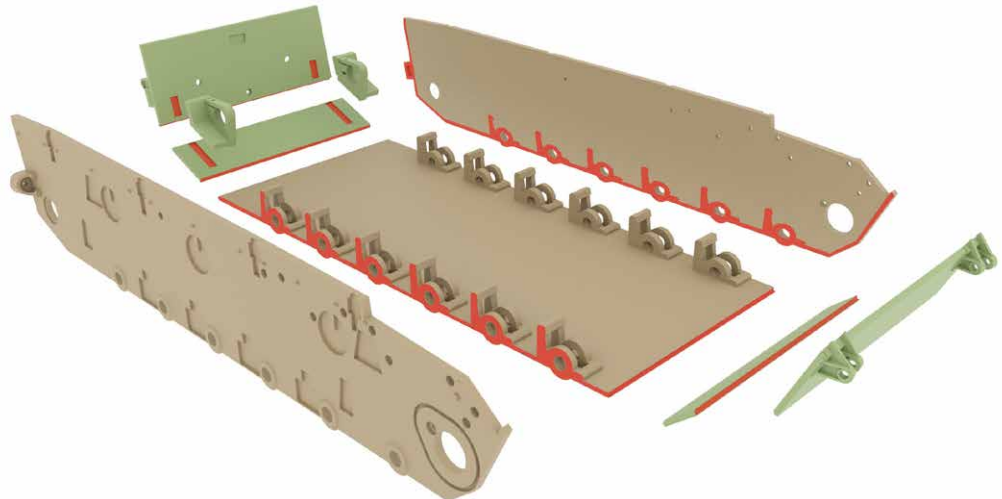

**Files:**

- A-14-4x
- A-15-FLEX-4x

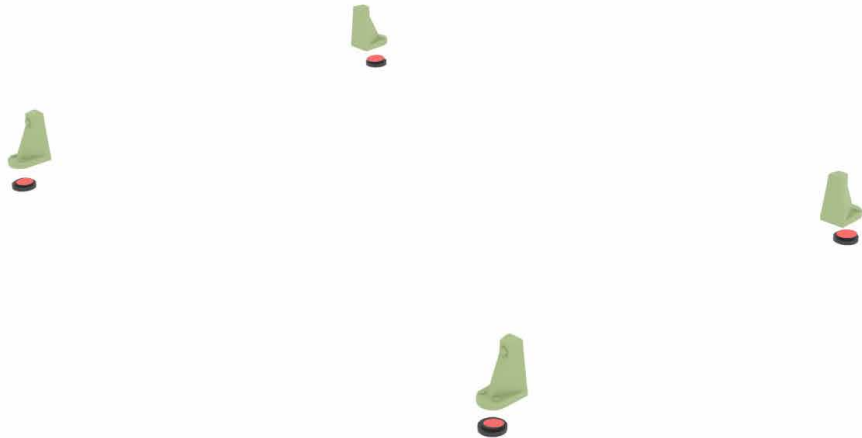

**Files:**

- A-14-4x
- A-15-FLEX-4x
- A-16-8x
- A-17-6x
- A-18-4x
- A-19-1-right-1x
- A-19-1-left-1x
- A-20-2x

- M3 16mm 2x
- Bearings-  
12x21x5mm-2x

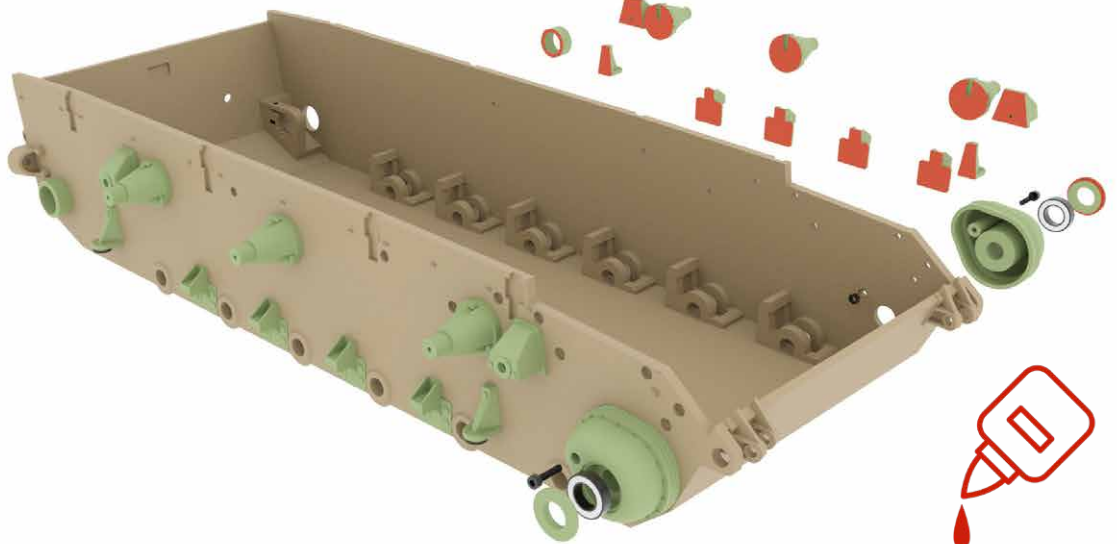

**Files:**

- A-21-6x
- A-22-6x
- A-23-12x
- A-24-FLEX-12x

- M3 16mm 6x

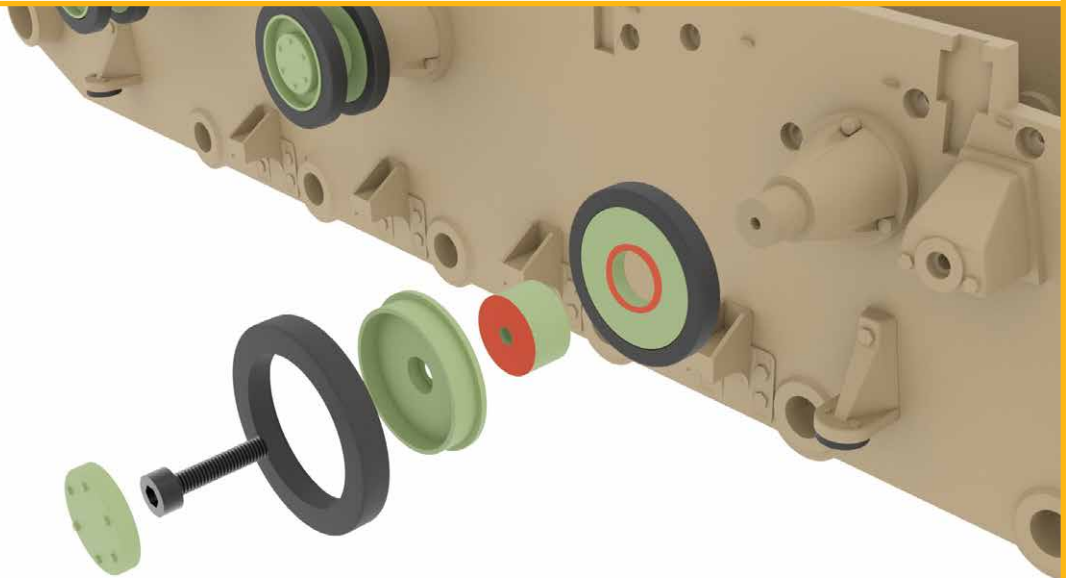

A

**Files:**

A-25-12x  
A-26-12x  
A-27-12x  
A-28-12x  
A-29-FLEX-12x

Ložiska  
10x15x4 mm

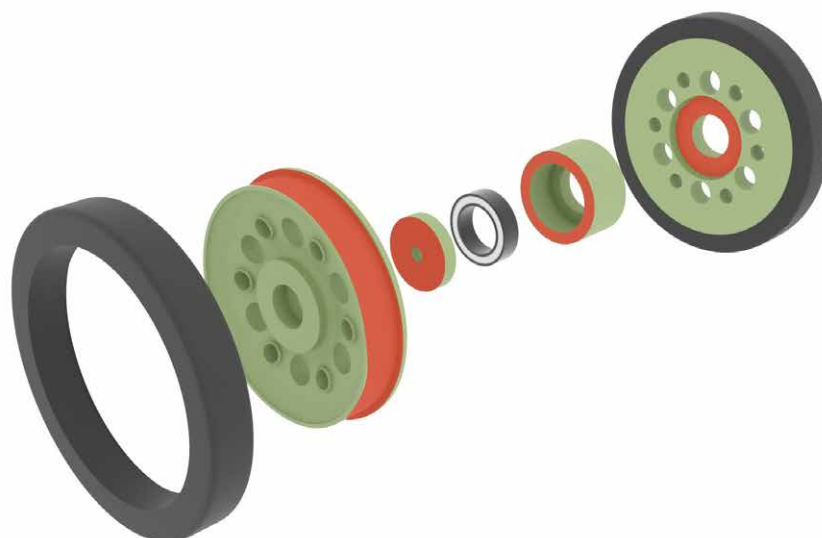

**Files:**

(A-25-12x, A-26-12x, A-27-12x, A-28-12x, A-29-FLEX-12x)  
A-30-12x  
A-31-right-2x  
A-31-left-2x  
A-32-right-4x  
A-32-left-4x  
A-32-12x



**Files:**

A-33-4x  
A-34-4x





Files:  
A-35-right-6x  
A-35-left-6x

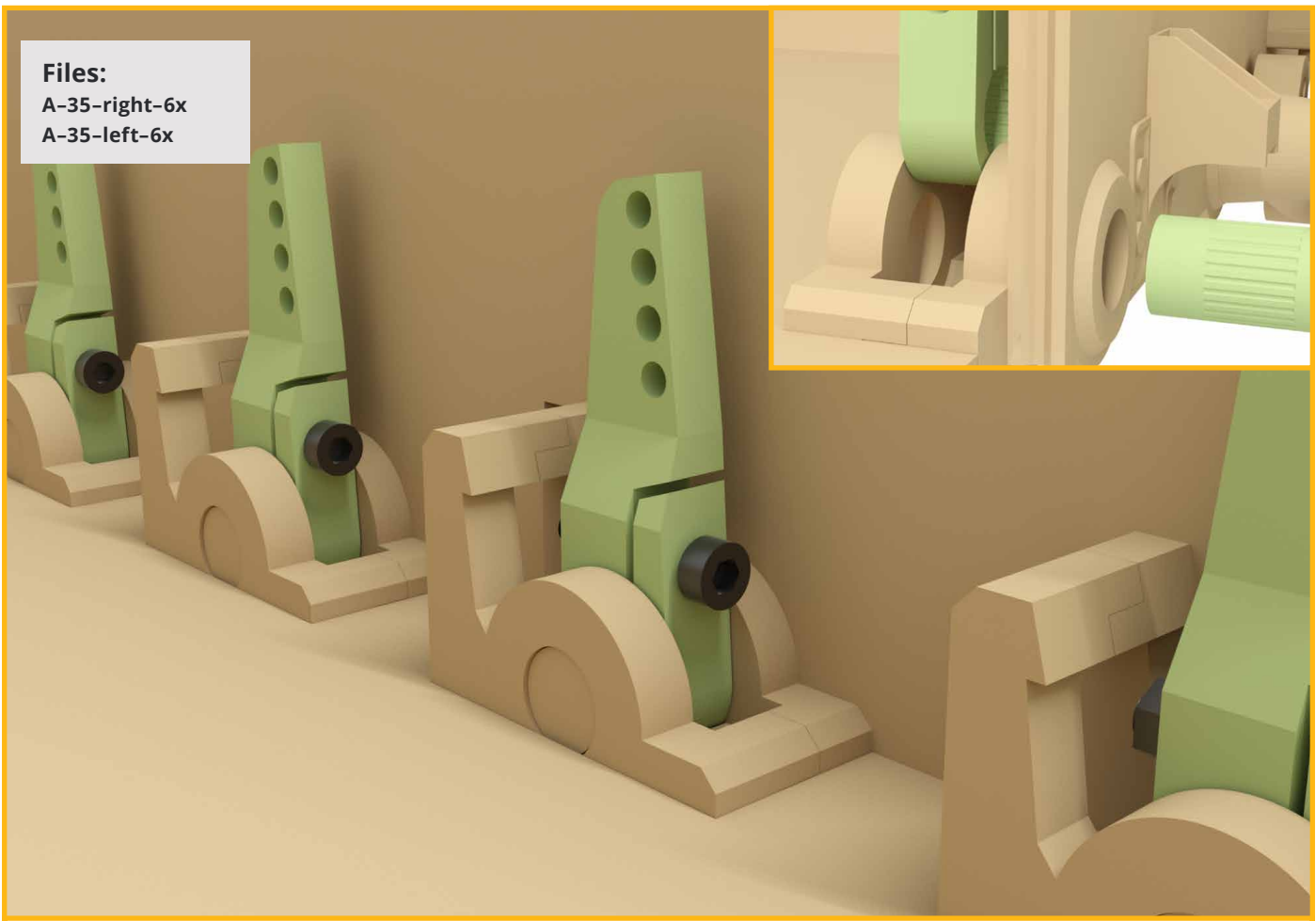

Files:  
A-36-12x  
Springs



**Files:**

- A-37-2x
- A-38-2x
- A-39-2x
- A-40-2x
- A-41-2x
- A-42-2x

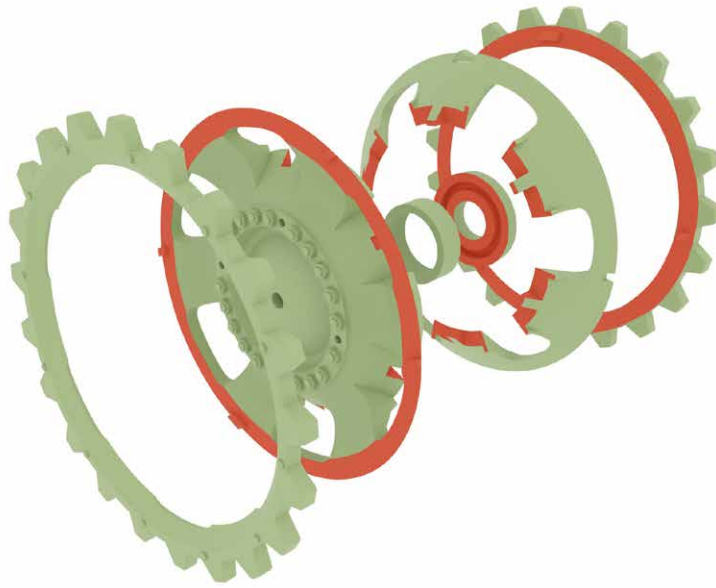

**Files:**

- A-43-2x
- A-44-4x
- A-45-2x
- A-46-2x
- A-47-6x

**Bearings**  
10x15x4 mm

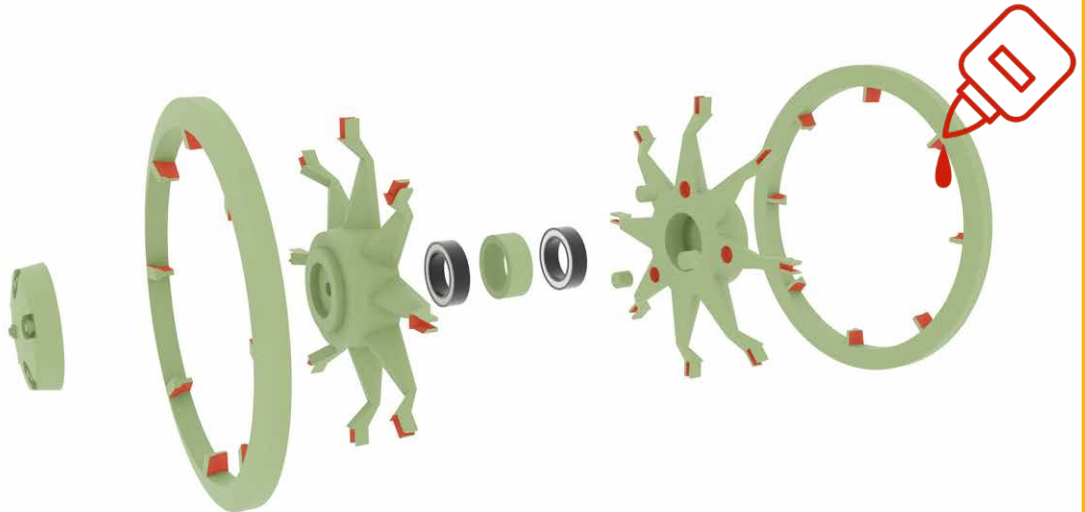

**Files:**

- A-49-2x
- A-50-left-1x
- A-50-right-1x
- A-51-2x
- A-52-2x



Files:  
A-48-2x

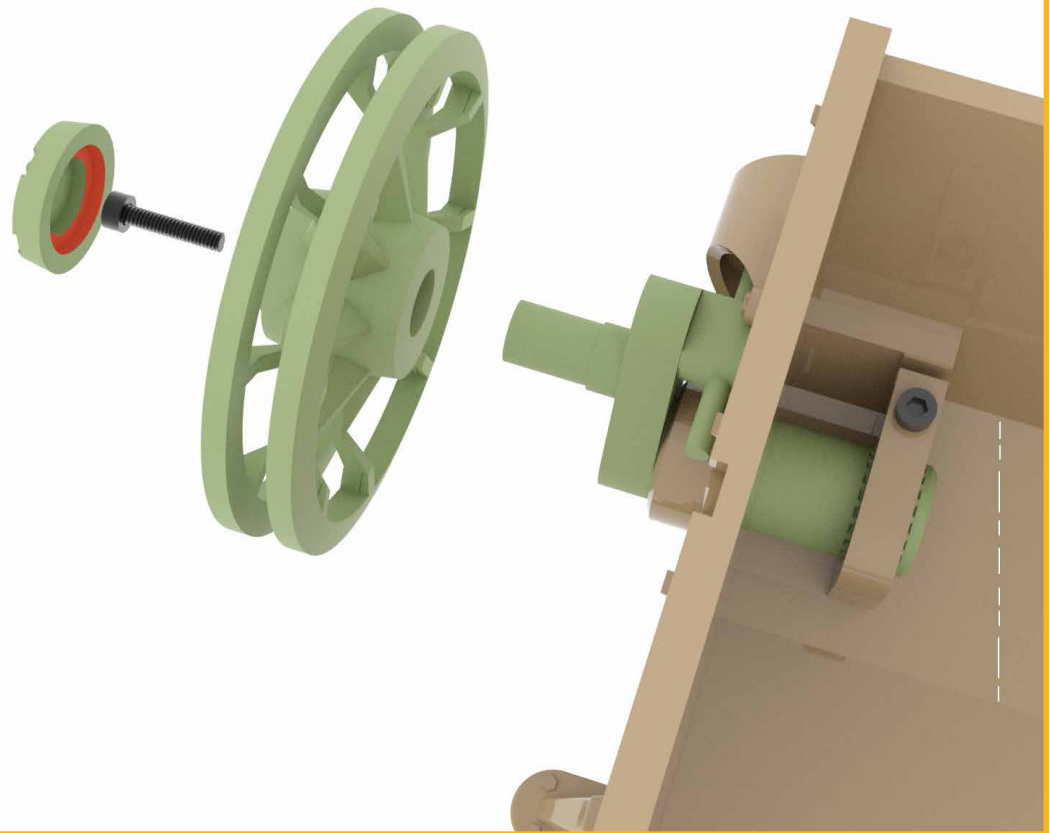

Files:  
A-53-left-1x  
A-53-right-1x  
A-54-left-1x  
A-54-right-1x  
A-55-1x  
A-56-1x  
A-57-1x

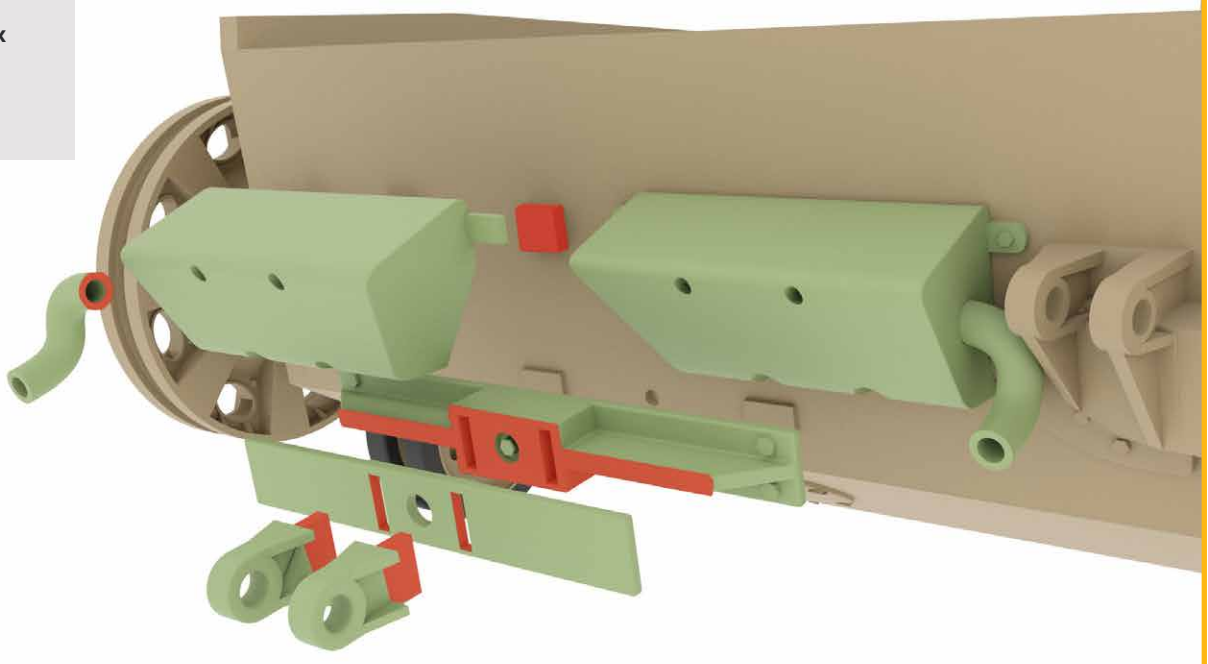

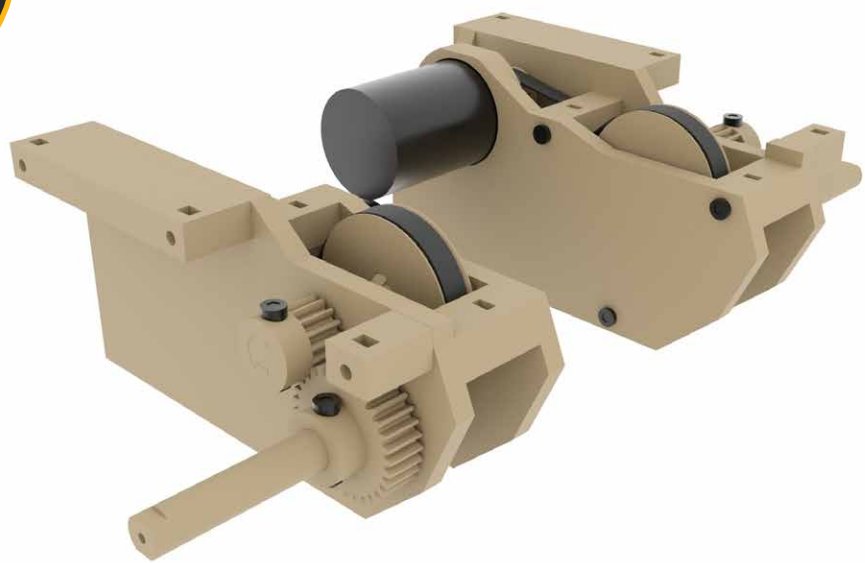

**Files:**

- P-1-right-1x
- P-1-left-1x
- P-2-right-1x
- P-2-left-1x
- P-3-right-1x
- P-3-left-1x

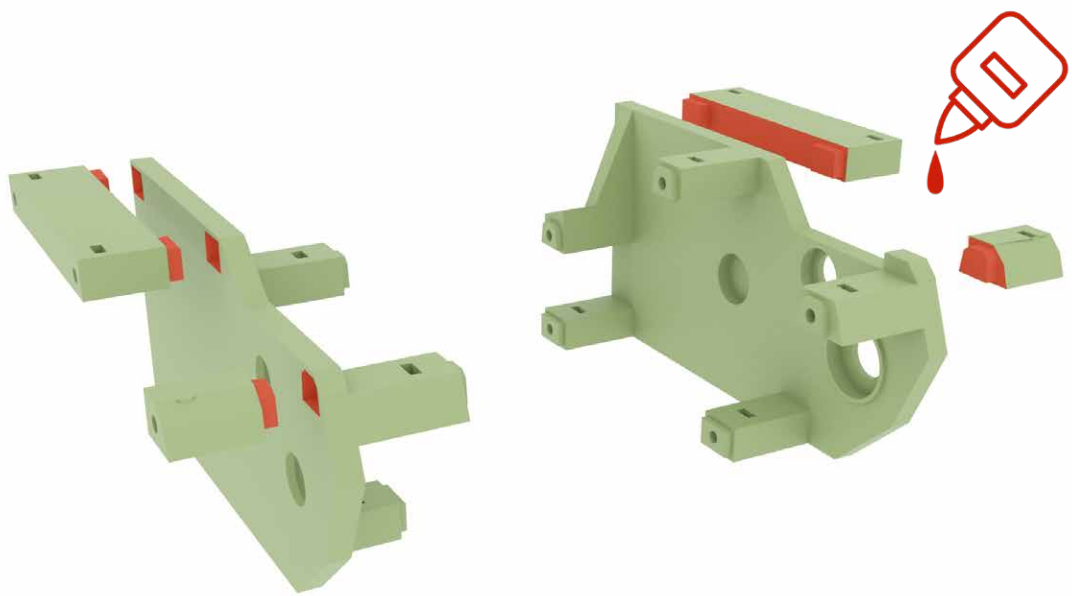

**Files:**

- P-4-2x
- P-5-2x
- M3 16mm 2x
- Bearings-12x21x5mm-2x

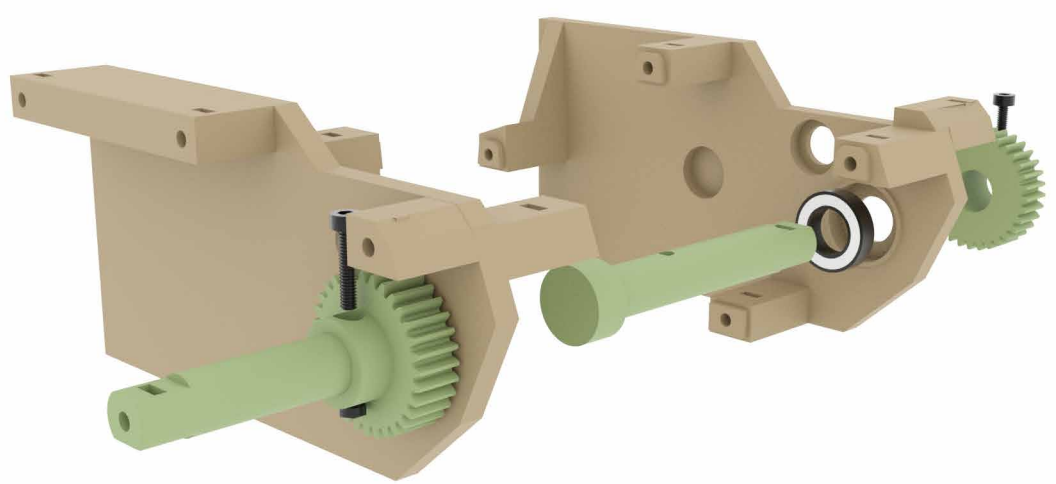

**Files:**

- P-6-2x
- P-7-2x
- P-8-2x
- P-9-2x
- P-10-2x

- Bearings-  
10x15x4mm-4x
- M3 16mm 2x

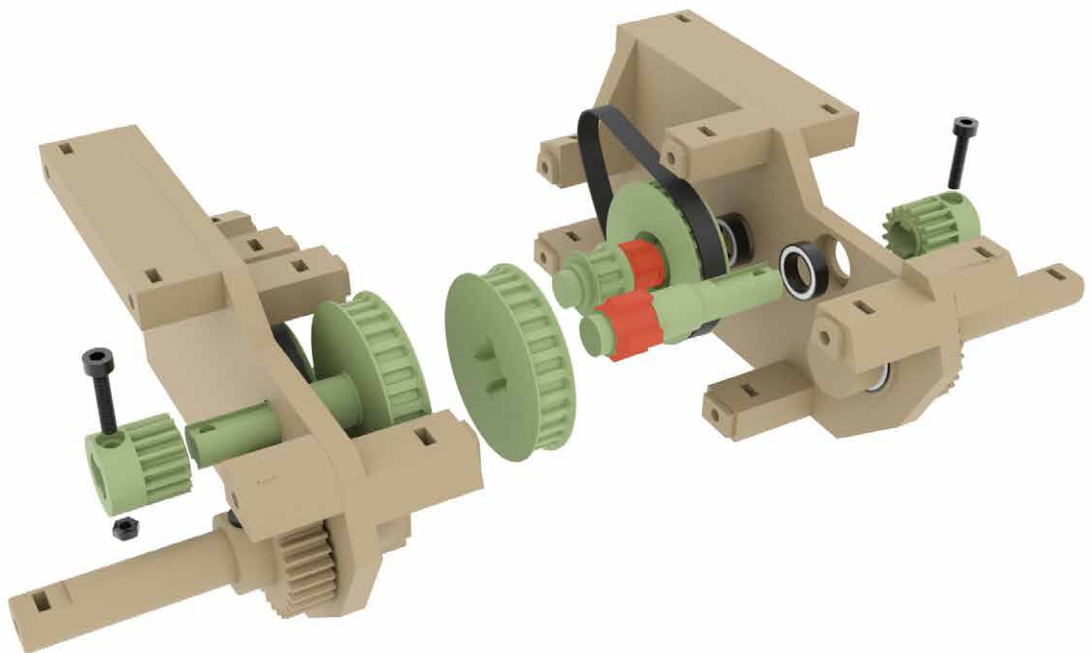

**Files:**

- P-11-2x
- P-12-right-1x
- P-12-left-1x

- M3 16mm 2x
- Bearings  
10x15x4mm-4x



Files:  
M3 16mm 12x

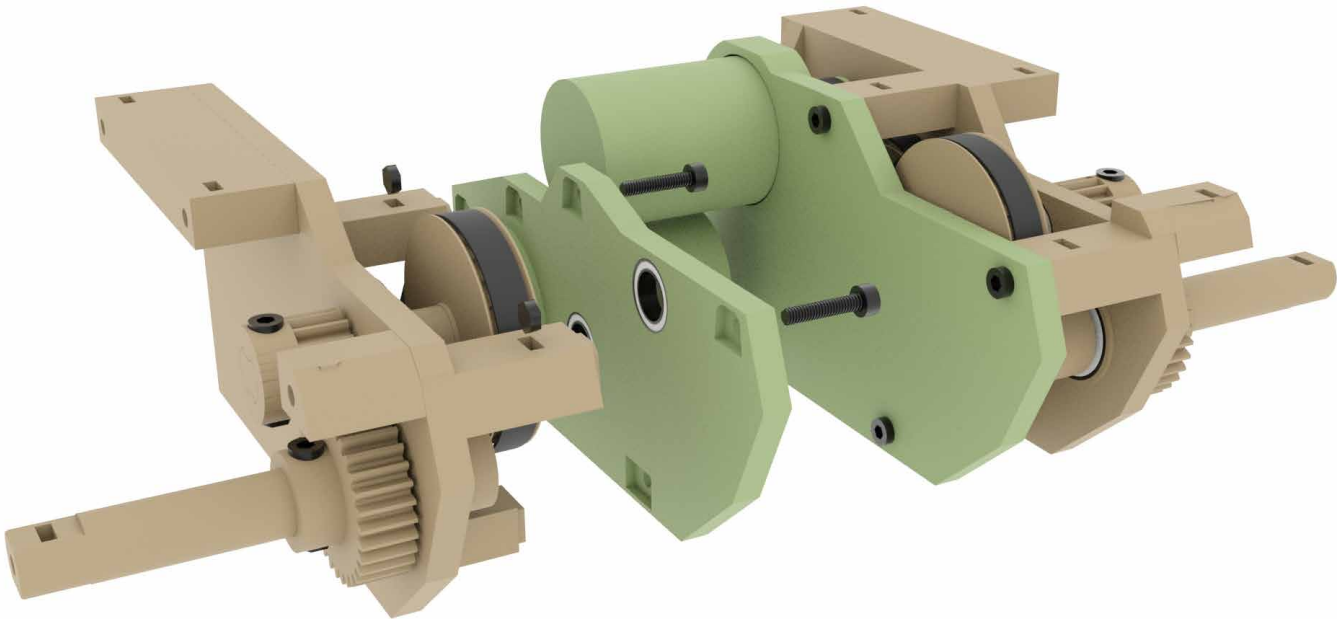



**Files:**

- B-1-1x
- B-3-1-right-3x
- B-3-1-left-3x



**Files:**

- B-2-1x
- B-3-1-right-3x
- B-3-1-left-3x
- B-4-right-1x
- B-4-left-1x

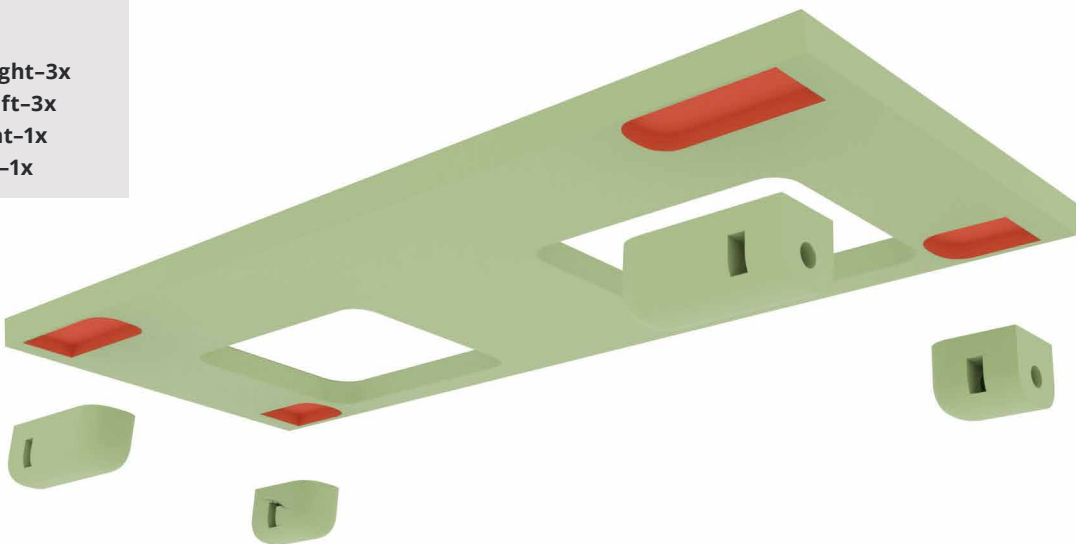

**B**

**Files:**

- B-5-2x
- B-6-2x
- B-7-2x
- B-8-2x
- B-9-1x

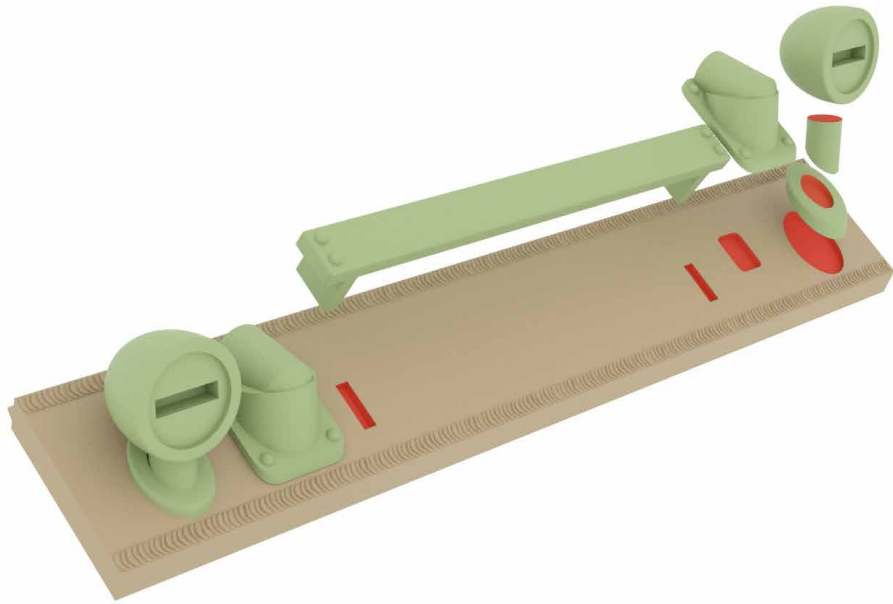

**Files:**

- B-10-4x
- B-11-4x
- B-12-2x
- B-13-1x

Wire 1mm

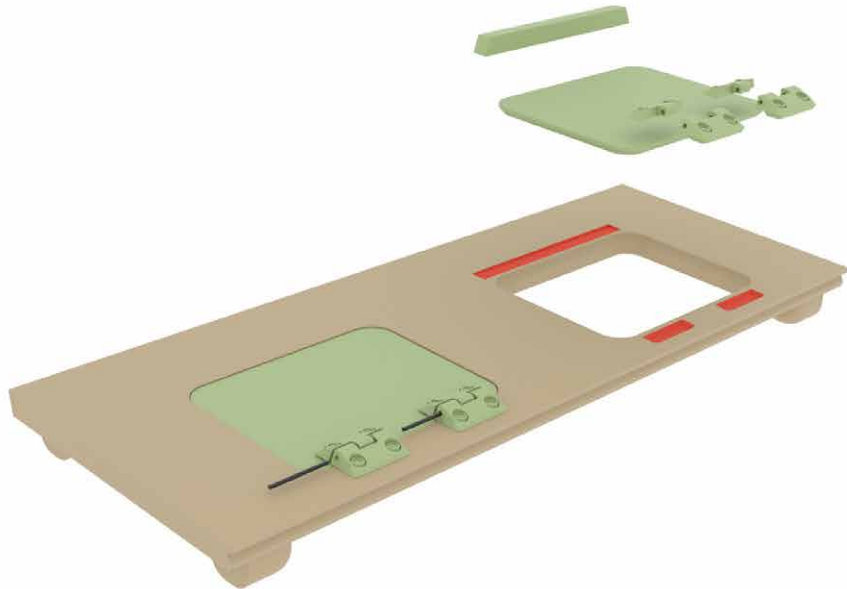

**Files:**

- B-14-1x
- B-15-1x
- B-3-1-right-3x
- B-3-1-left-3x
- B-3-2-right-2x
- B-3-2-left-2x

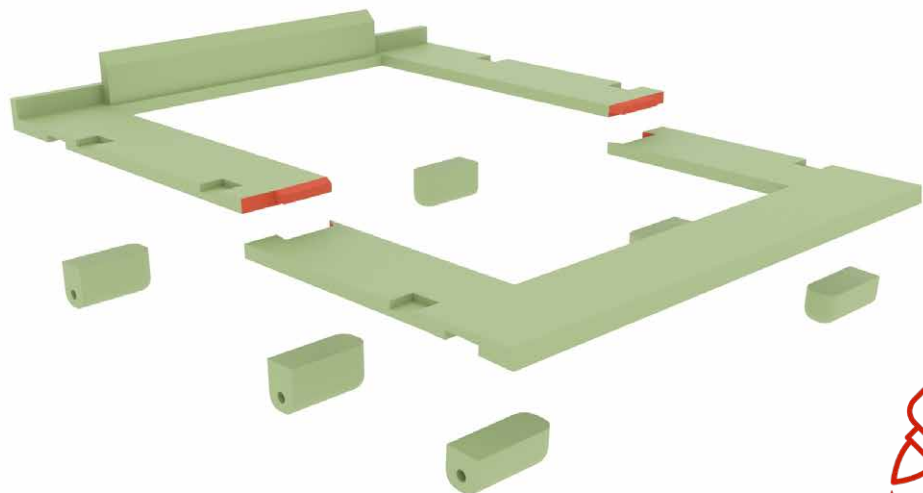



Files:

- B-16-1x
- B-17-1x
- B-18-1x
- B-19-1x
- B-20-1x
- B-21-1x



Files:

- B-22-right-1x
- B-22-left-1x
- B-23-right-1x
- B-23-left-1x
- B-24-6x

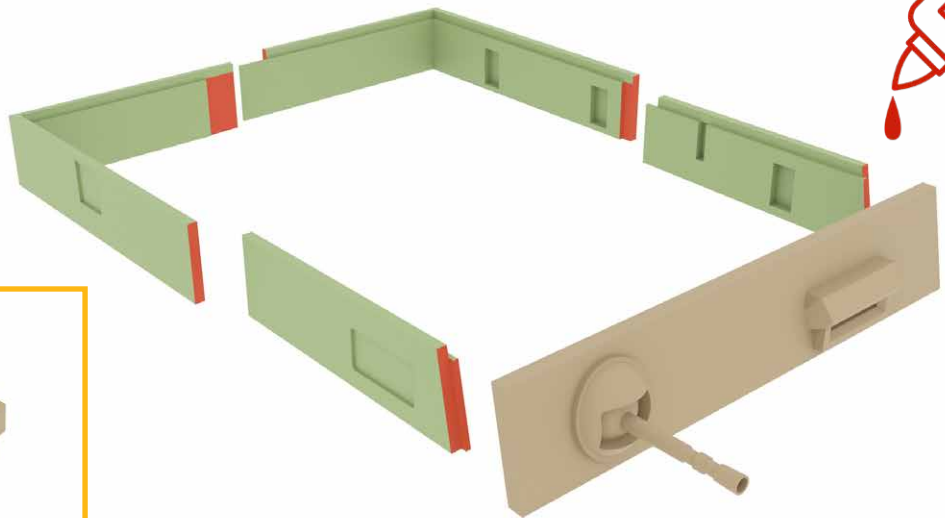

Files:

- B-25-2x
- B-26-1x
- B-27-1x
- B-28-2x

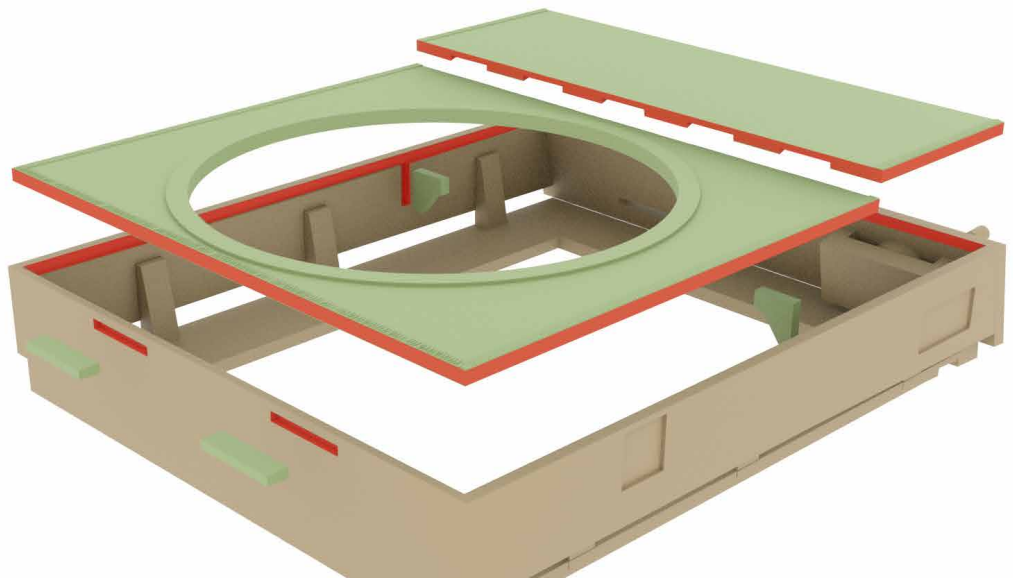



Files:  
C-1-1x  
C-2-1x

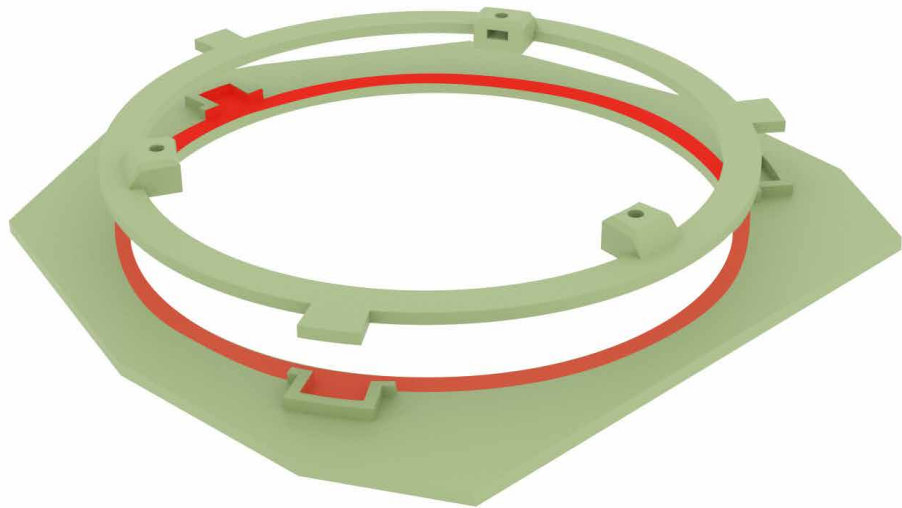

Files:  
C-3-1x

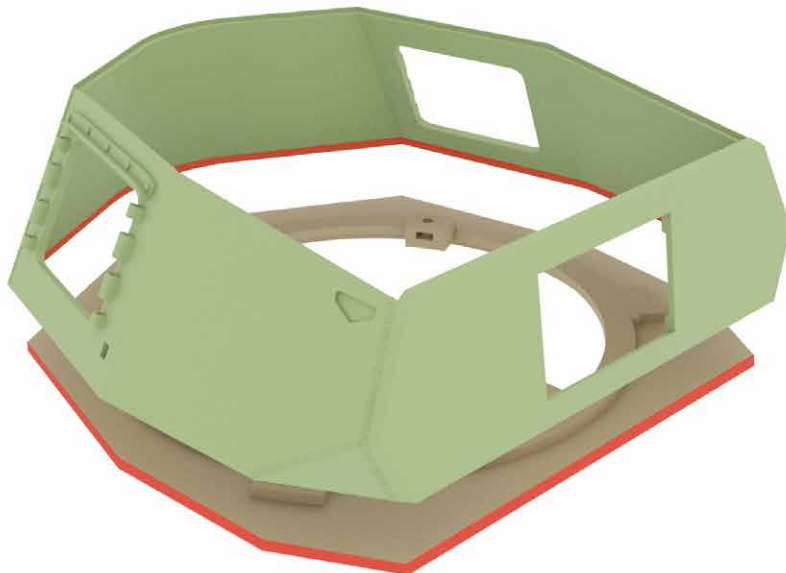

**Files:**

- C-4-1-1x
- C-4-2-1x
- C-5-1x
- C-6-right-1x
- C-6-left-1x
- C-7-right-1x
- C-7-left-1x

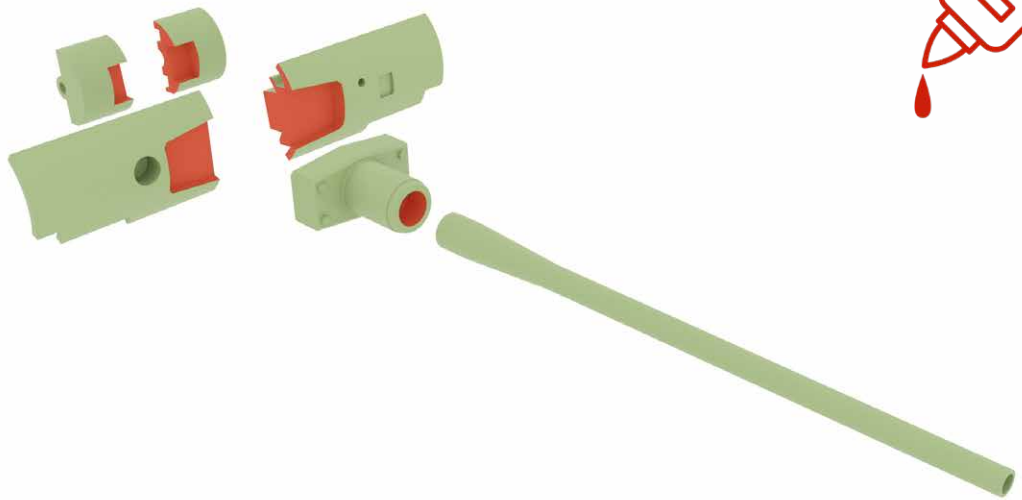

**Files:**

- C-8-right-1x
- C-8-left-1x
- C-9-1x

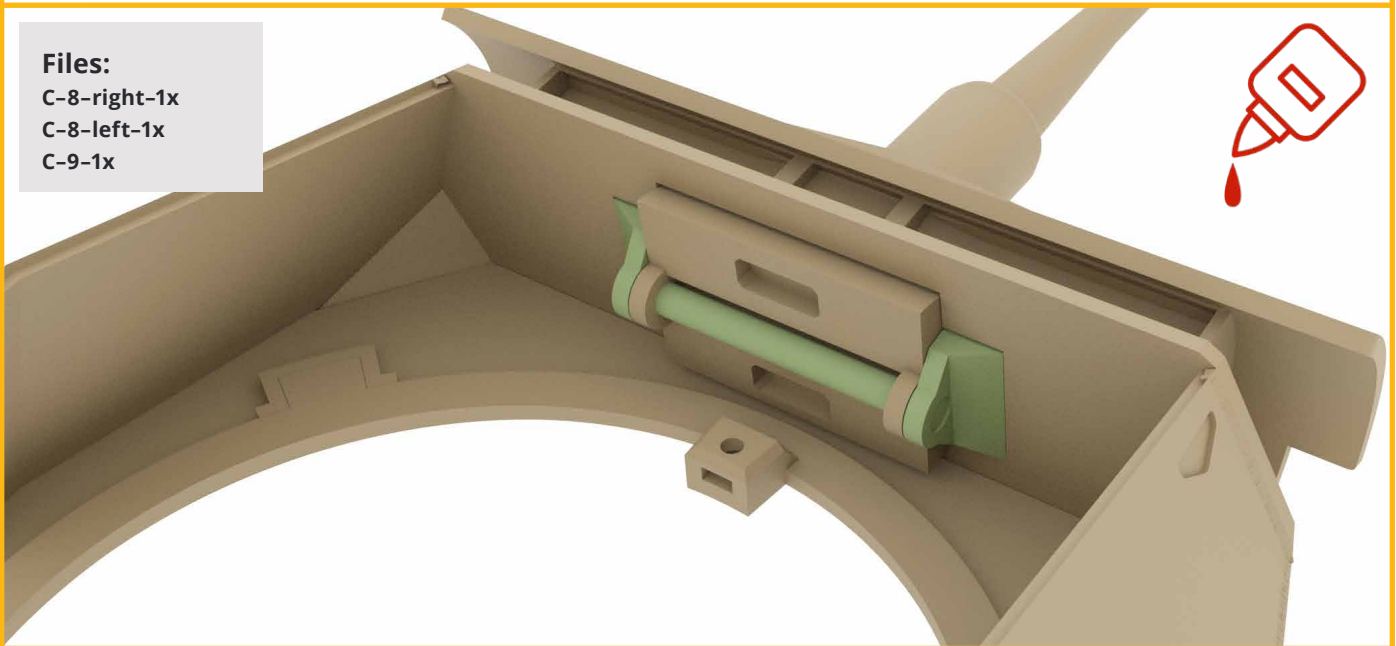

**Files:**

- C-10-1x





**Files:**  
C-11-1x  
C-12-1x

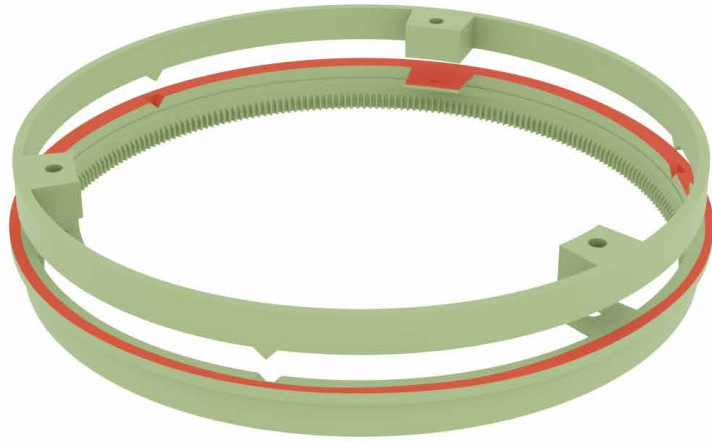

**Files:**  
B-23-2x  
B-24-1x  
B-25-1x

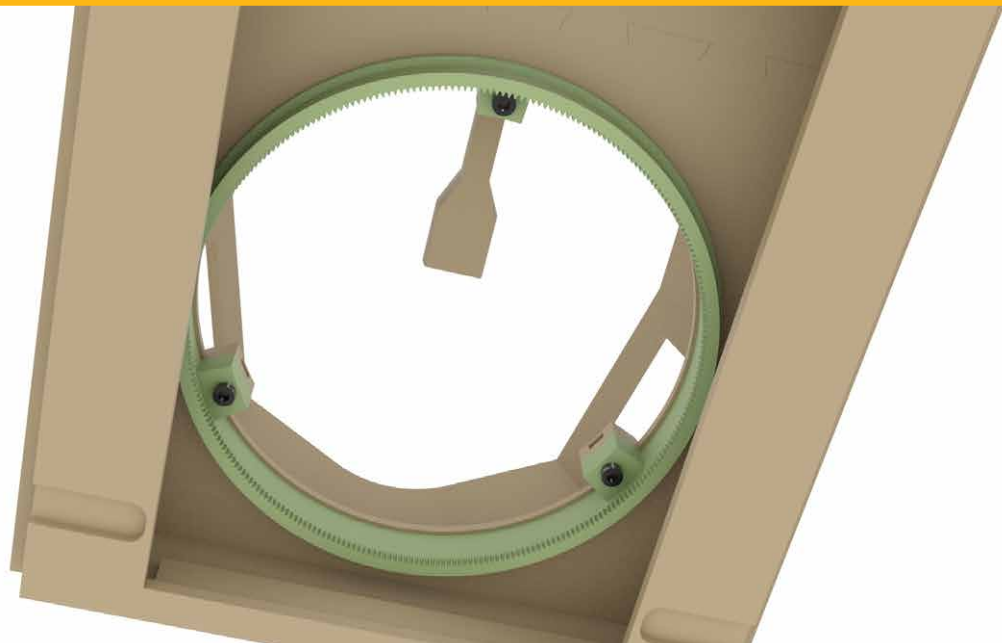
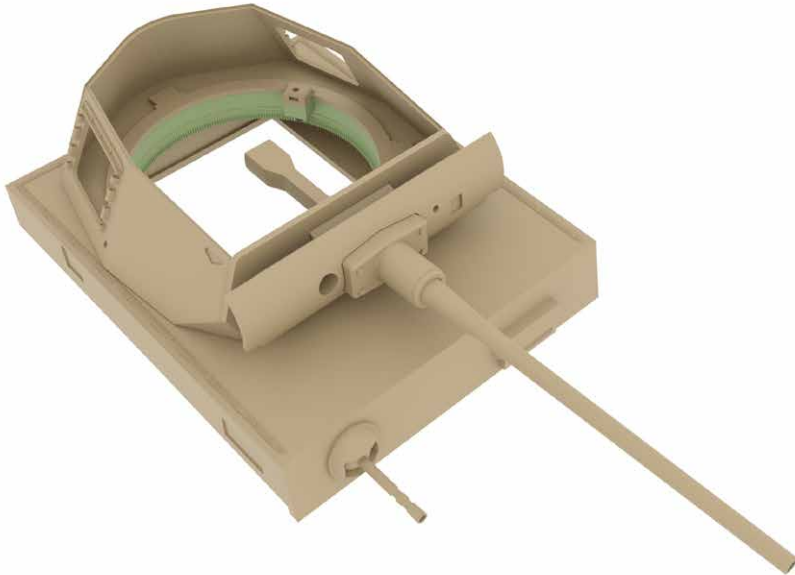

**Files:**

- C-13-1x
- C-14-1x
- C-15-1x
- C-16-1x
- C-17-1x
- C-18-1x
- C-19-1x

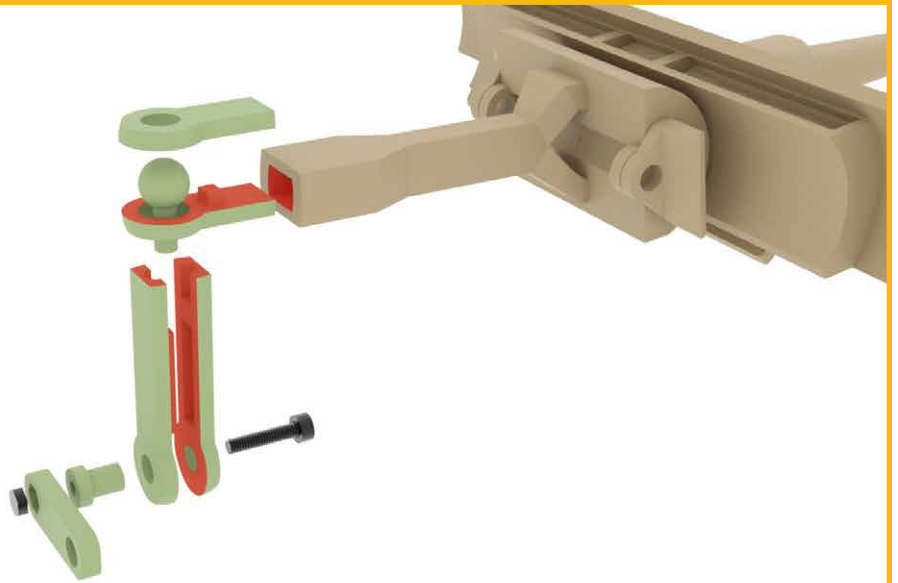

**Files:**

- C-20-1x
- C-21-1x
- C-22-1x

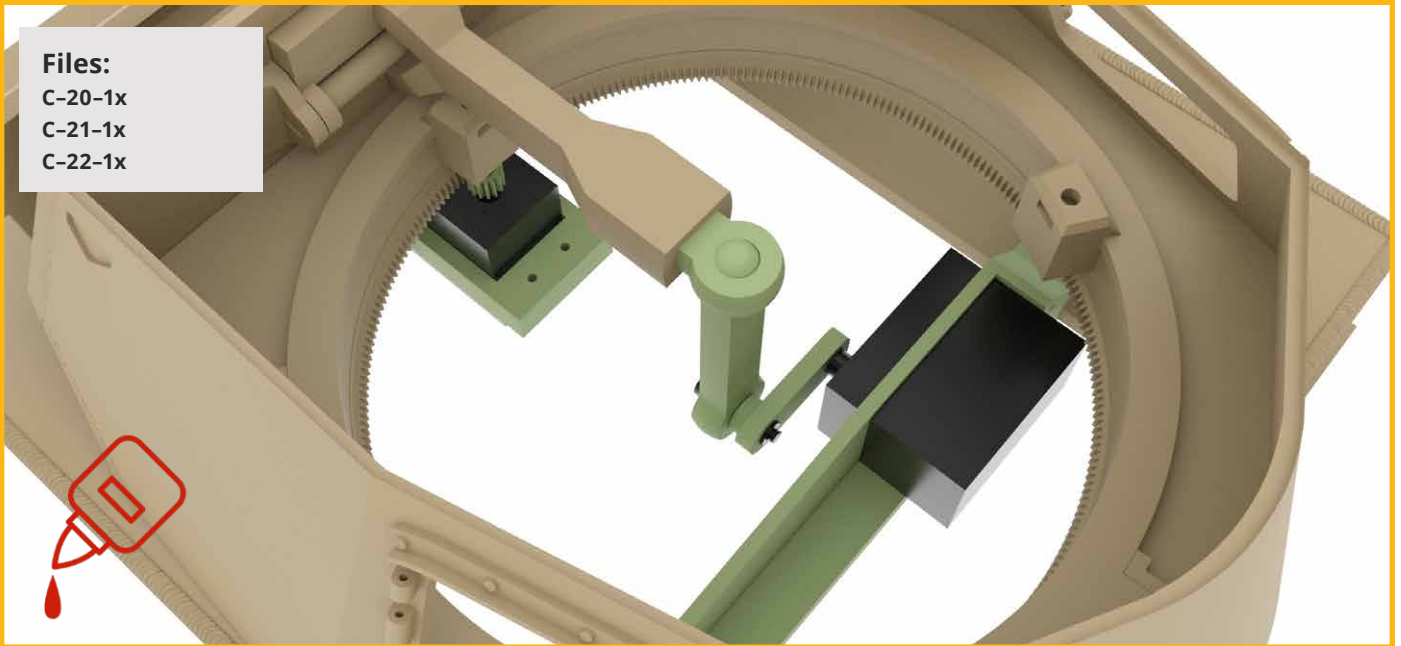

**Files:**

- C-23-1x
- C-24-1x

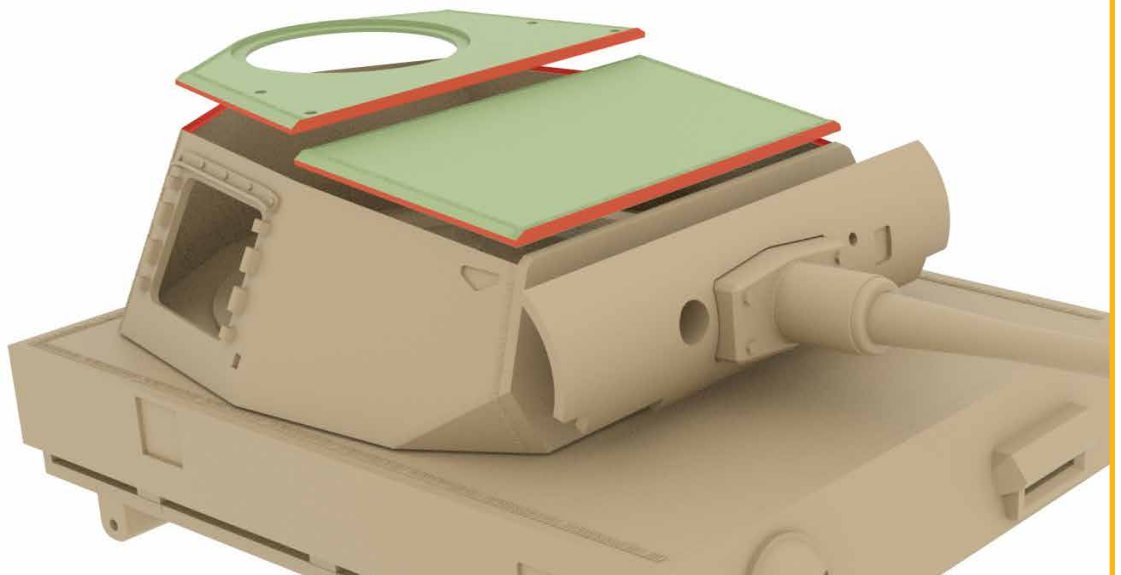

**Files:**

C-25-1x  
 C-26-1x  
 C-27-3x

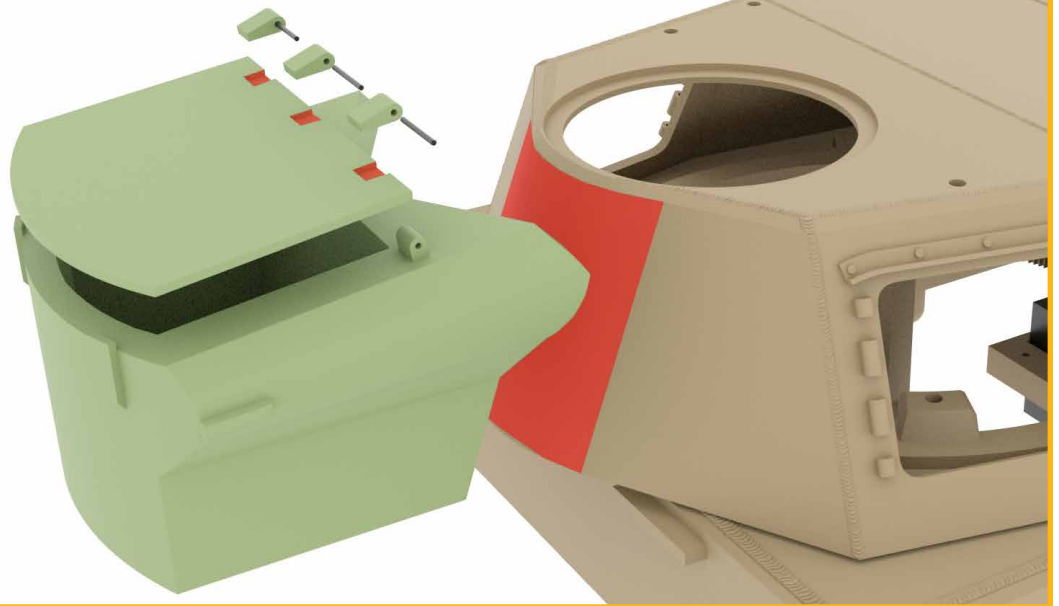
**Files:**

C-28-2ks  
 C-29-2ks  
 C-30-2ks  
 C-31-2ks  
 C-32-1ks  
 C-33-1ks  
 C-34-right-1ks  
 C-34-left-1ks  
 C-35-right-1ks  
 C-35-left-1ks

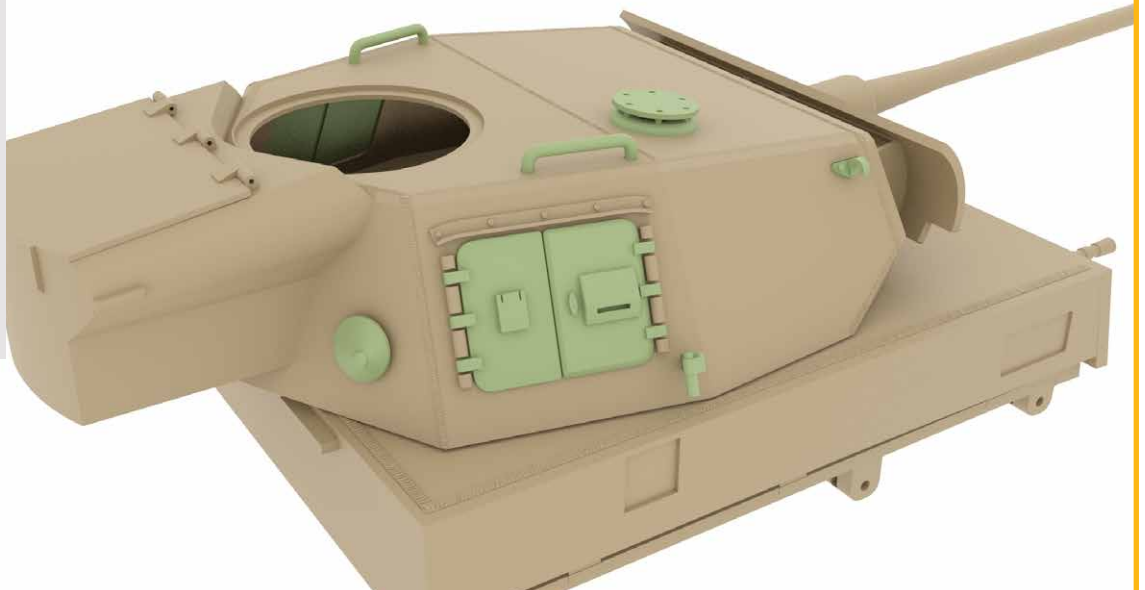
**Files:**

C-36-1x  
 C-37-1x  
 C-38-1x  
 C-39-1x  
 C-40-2x  
 C-41-1x



**Files:**

D-1-right-1x  
 D-1-left-1x  
 D-2-right-1x  
 D-2-left-1x  
 D-3-right-1x  
 D-3-left-1x  
 D-4-right-1x  
 D-4-left-1x

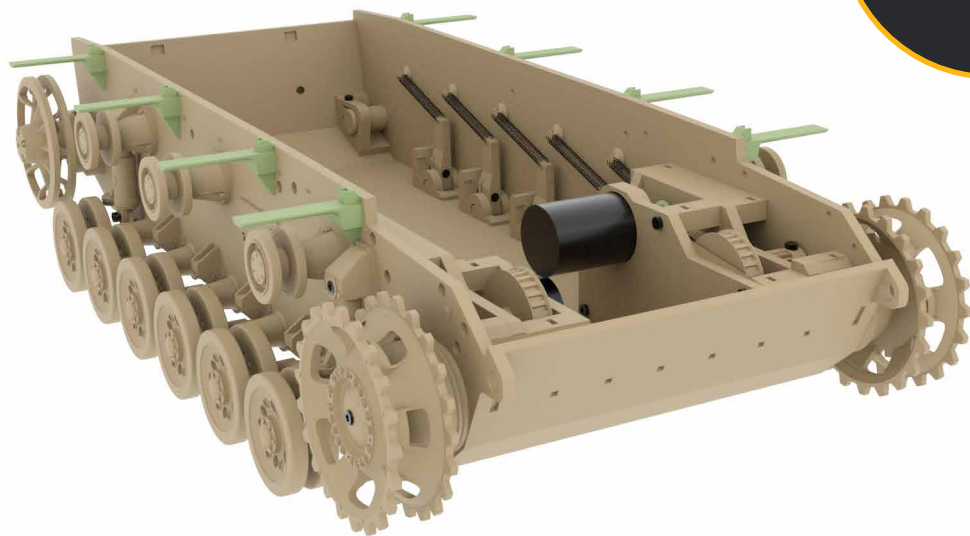
**Files:**

D-5-right-1x  
 D-5-left-1x  
 D-6-right-1x  
 D-6-left-1x  
 D-7-right-1x  
 D-7-left-1x  
 D-8-right-1x  
 D-8-left-1x  
 D-9-right-1x  
 D-9-left-1x

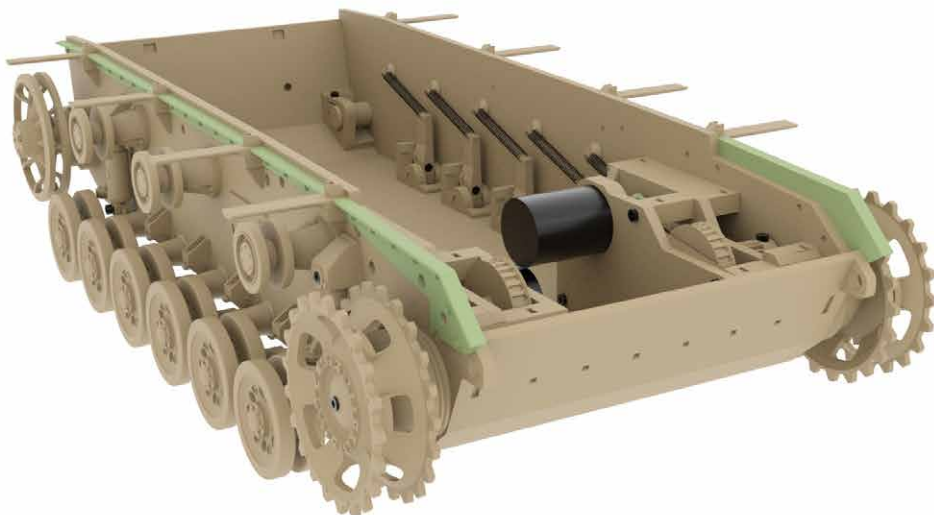
**Files:**

D-10-right-1x  
 D-10-left-1x  
 D-11-right-1x  
 D-11-left-1x  
 D-12-right-1x  
 D-12-left-1x

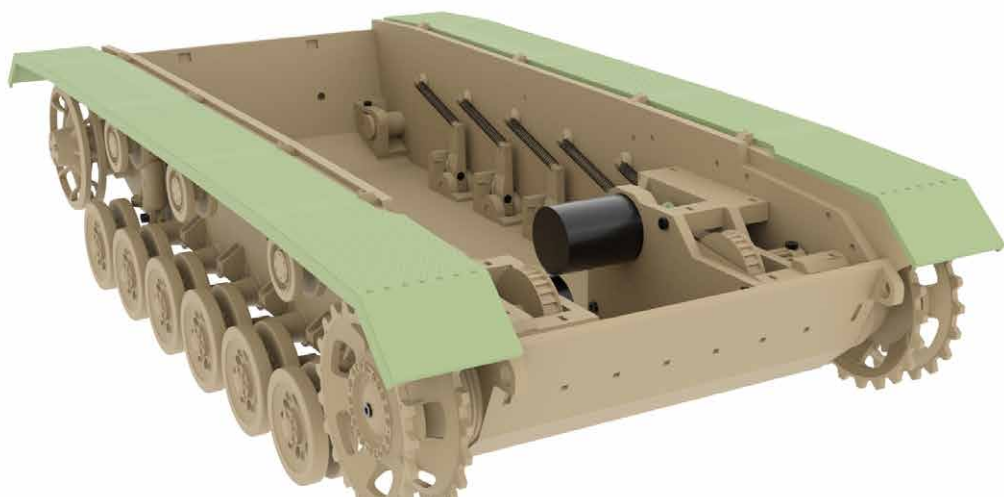

D

Files:  
D-13-4x

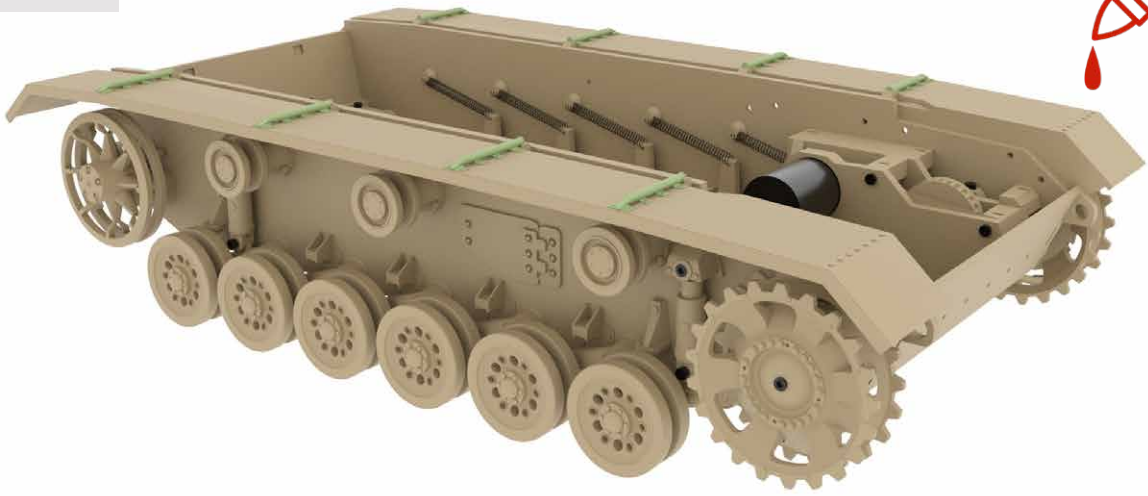

E

Files:  
E-1-1x  
E-2-1x

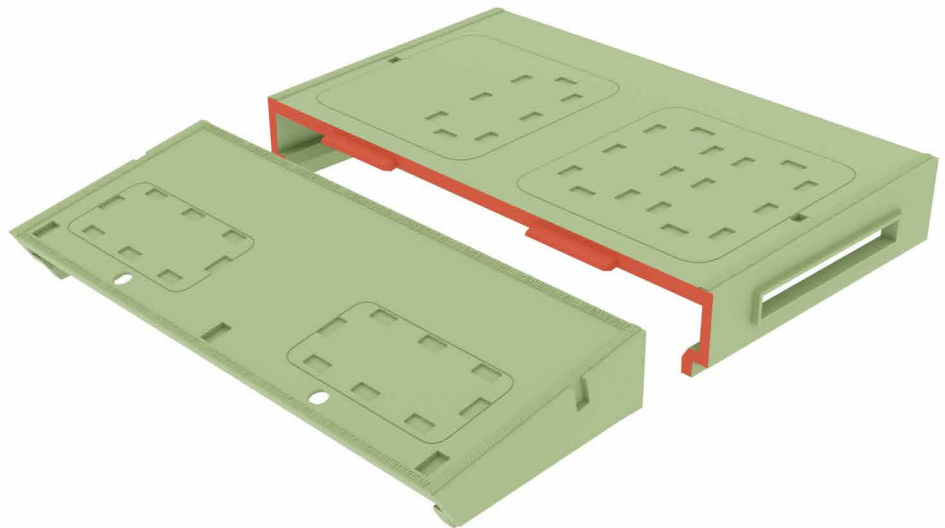



**Files:**  
E-3-5x  
E-4-40x

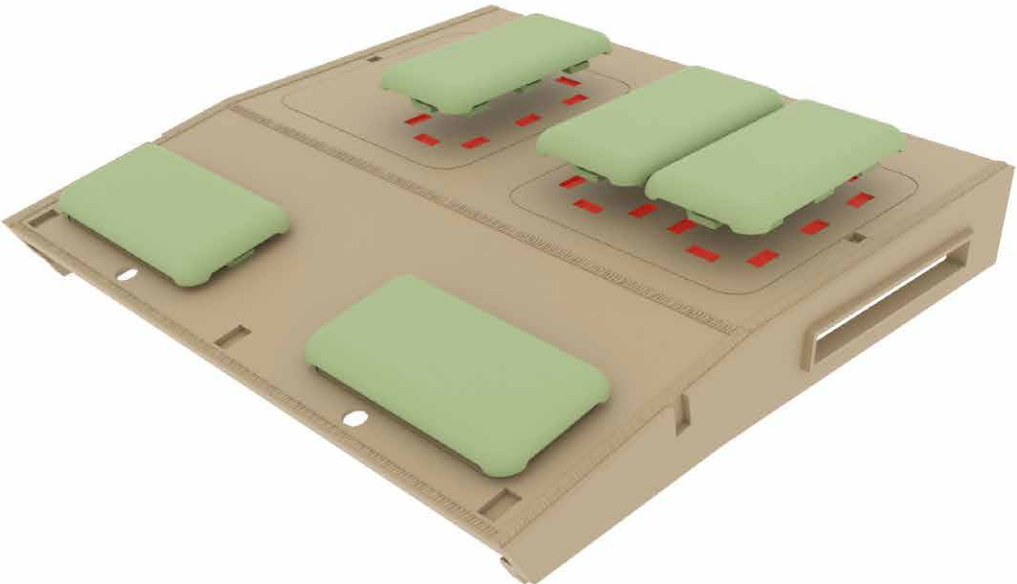
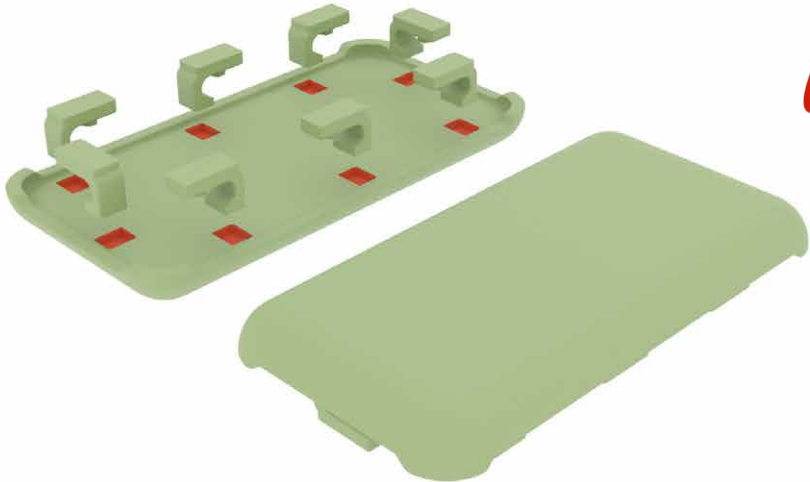

**Files:**  
E-5-right-1x  
E-5-left-1x  
E-6-2x  
E-7-right-1x  
E-7-left-1x

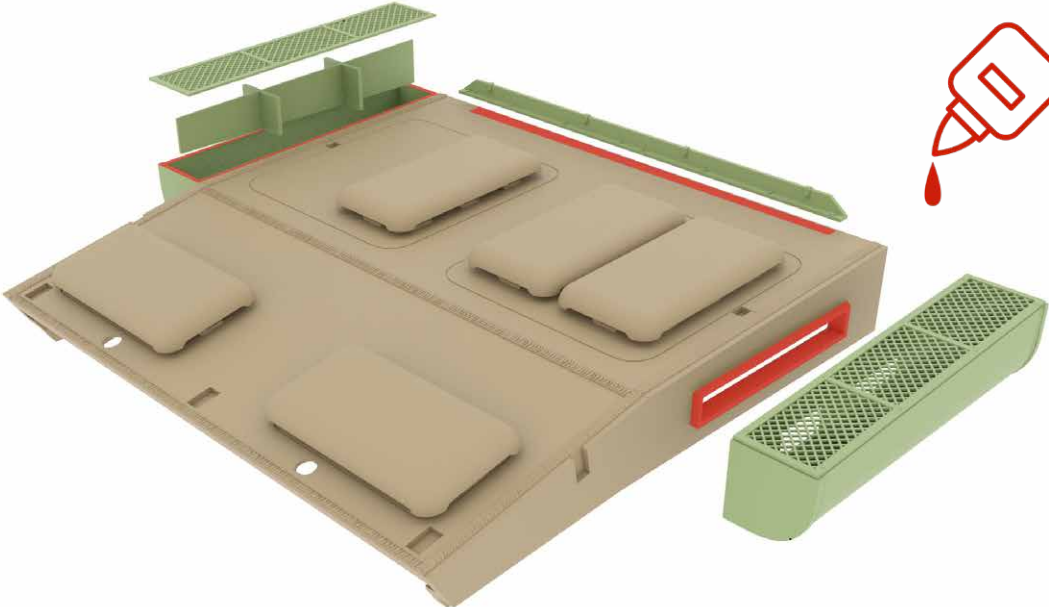

Files:  
E-7-2x



Files:  
E-9-1-1x  
E-9-2-1x  
E-9-3-2x  
E-10-1x

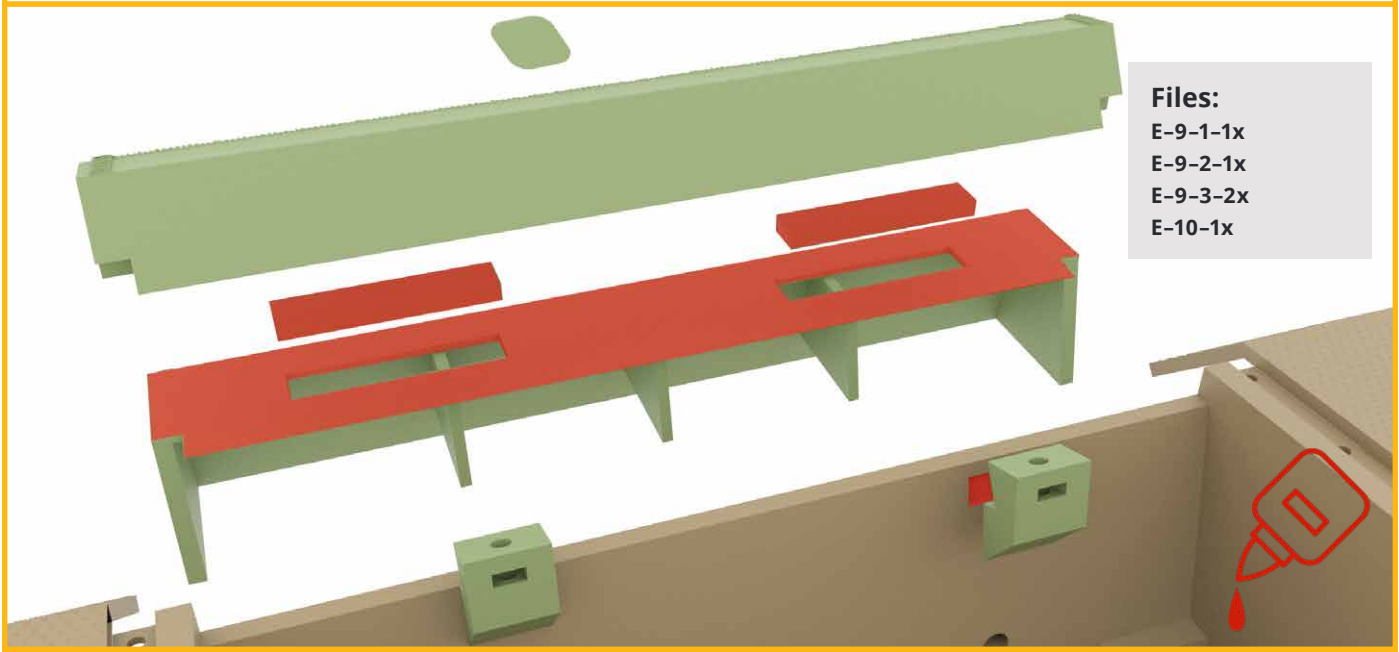

# F

**Files:**

- F-1-1x
- F-2-1x
- F-3-1x
- F-4-1x
- F-5-2x



**Files:**

- F-6-5x
- F-7-right-1x
- F-7-left-1x
- F-8-right-1x
- F-8-left-1x
- F-9-3x

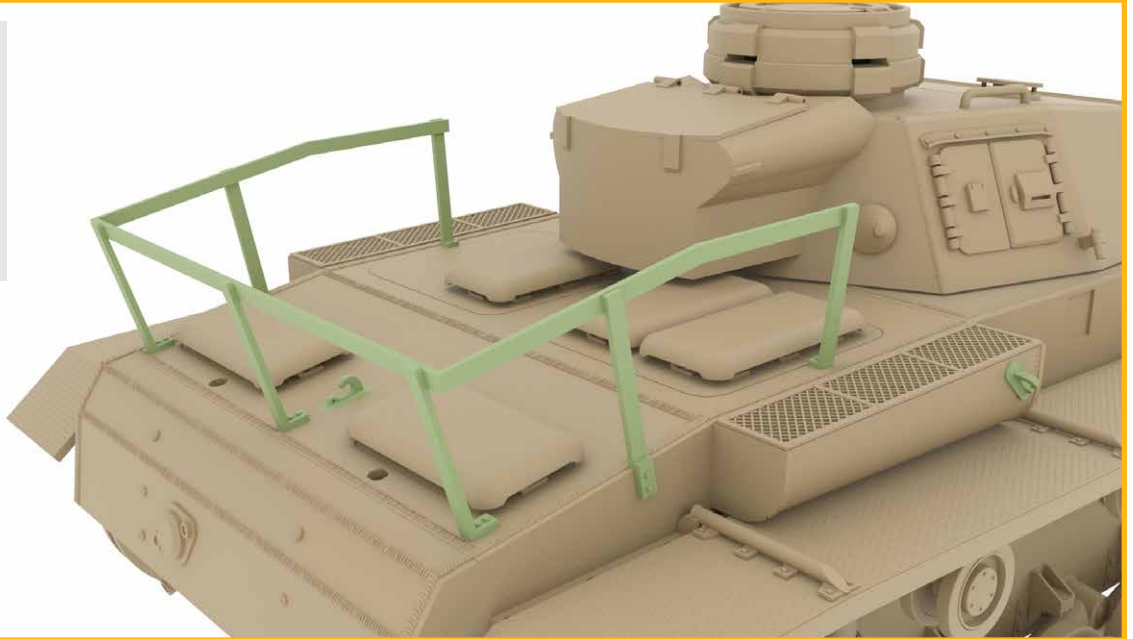

**Files:**

- F-10-2x
- F-11-1x
- F-12-2x
- F-13-1x
- F-14-2x
- F-15-1x
- F-16-1x
- F-17-1x
- F-18-1x
- F-19-1x
- F-20-1x
- F-21-1x
- F-22-1x
- F-23-1x
- F-24-1x
- F-25-1x
- F-26-1x

- G-1-19x
- G-2-19x



Files:  
G-1-188x  
G-2-188x

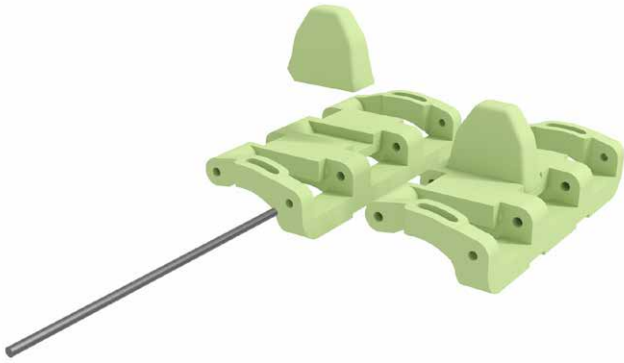

Files:  
G-3-right-94x  
G-3-left-94x  
G-2-188x





autor: **Petr Školař**  
web: **[www.3dtiks.store](http://www.3dtiks.store)**  
e-mail: **[3dtisk@gpstudio.cz](mailto:3dtisk@gpstudio.cz)**