

VERZE 1.3.

2022



Panzer III

Panzerkampfwagen III

PzKpfw III

1:10

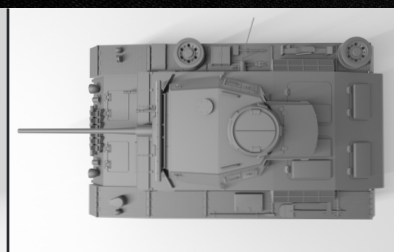

NÁVOD KE STAVBĚ

www.3dtisk.store

Stavební manuál

3d tisk

TISKLÉ NA 3D TISKÁRNĚ ORIGINAL PRUSA I3 MK3S+

Nastavení tisku v PrusaSlicer-2.4.1

Nastavení tisku: **0.20mm** (u spojovacích dílů **0.15mm** přesnější např. vkládání kuličkových ložisek)

Výplň: **15%** (u pohyblivých částí 80% např. převodovky)

Filament: **Prusa PLA**

Souborů STL: **246 ks**



Tisk s minimálním množstvím vzpěr, intuitivní snadná stavba.

Spojovací mat., elektro

SPOJOVACÍ MATERIÁL

Šrouby

M3 x 15mm

M3 x 10mm

M3 x 50 mm 2ks

M3 matka

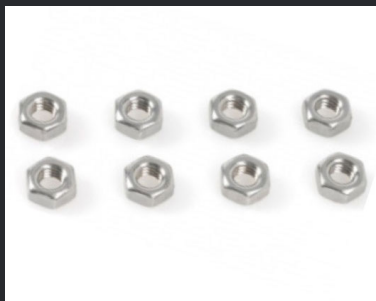

Ložiska:

Kuličkové ložisko 9x24x7mm 4ks

Kuličkové ložisko 8x16x5mm 22ks

Kuličkové ložisko 7x13x4mm 6ks



Pružiny:

0,5 mm, 30 mm, 5 mm

Drát vázací: tl. 1 mm

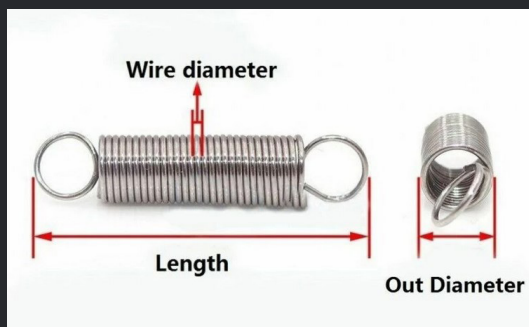

Sekundové lepodlo

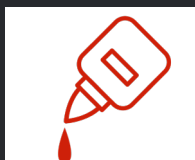

ELEKTRICKÉ SOUČÁSTKY

Motory:

Stejnoseměrné motory 540

Provozní napětí 5-12V

Délka hřídele 9 mm

Rozměry (Ø x d) 35.8 mm x 50 mm

Jmenovité napětí 7,2 V/DC

Průměr hřídele 3,17 mm

Pastorek 17T

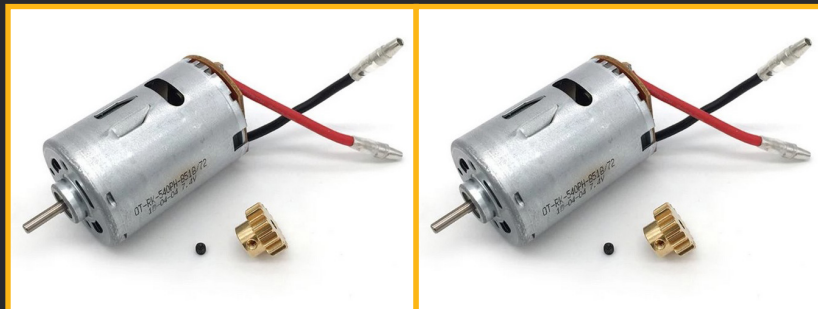

Regulátory:

obousměrný elektrický regulátor rychlosti 40A 2x, pro stejnosměrné motory.

Zde je řešení v jednom: https://www.aliexpress.com/item/1005003605105604.html?spm=a2g0o.order_list.0.0.36281802RPbP2Y

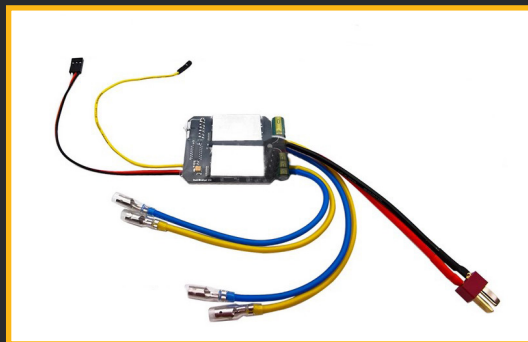

Serva:

serva byla použita tato:

https://www.aliexpress.com/item/1005001415643140.html?spm=a2g0o.order_list.0.0.36281802RPbP2Y

html?spm=a2g0o.order_list.0.0.36281802RPbP2Y

Servo pro otáčení věže se musí upravit například podle tohoto návodu:

<https://www.youtube.com/watch?v=4Z-j6bUJTQ8>



SCHEMA ZAPOJENÍ

SERVO-1

servo pro polohování kanónu

SERVO-2

Upravené servo pro otáčení věže

PŘIJÍMAČ -RX

Minimálně 4 kanálový přijímač, pro řízení 2x motor, 1x servo otáčení věže, 1x polohování kanónu.

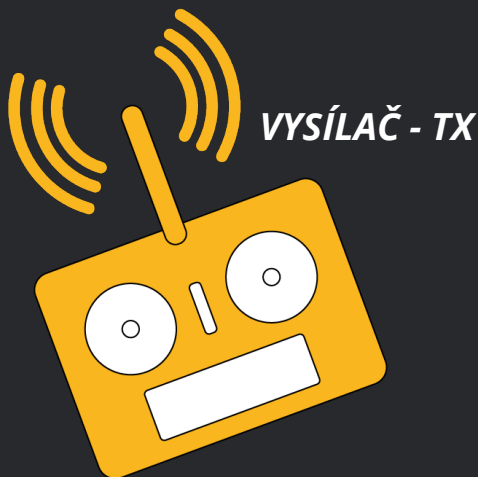

MOTORY

Stejnoseměrné motory 540

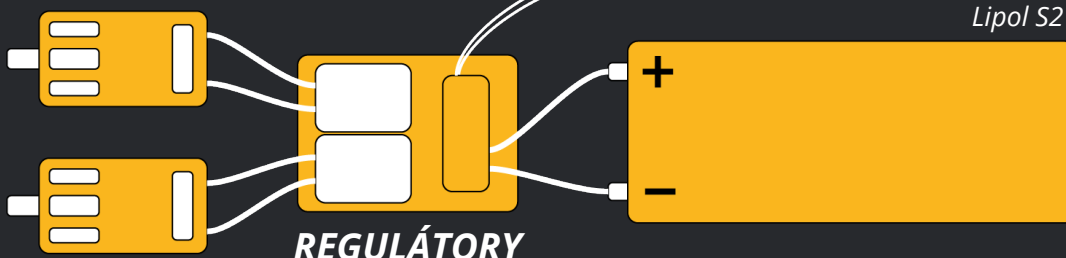

REGULÁTORY

BATERIE

Lipol S2 7,4 V

Panzer III

Panzerkampfwagen III

PARAMETRY MODELU

Měřítko: 1:10

Rozměr: 620 x 310 x 270 mm

Váha: 3,3 Kg



☒ III 1234567890

D

C

B

P

A

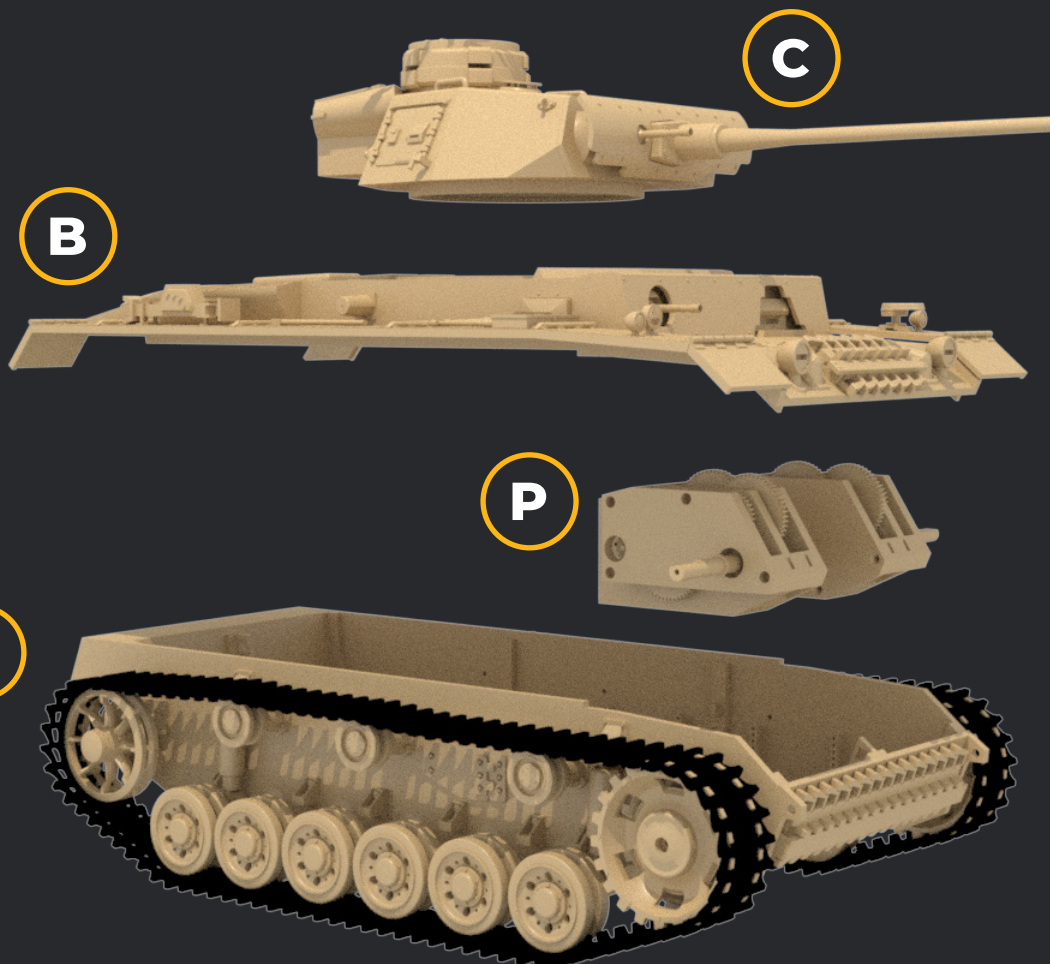

autor: Petr Školař

web: www.3dtiks.store

e-mail: 3dtisk@gpstudio.cz

Panzer III

A

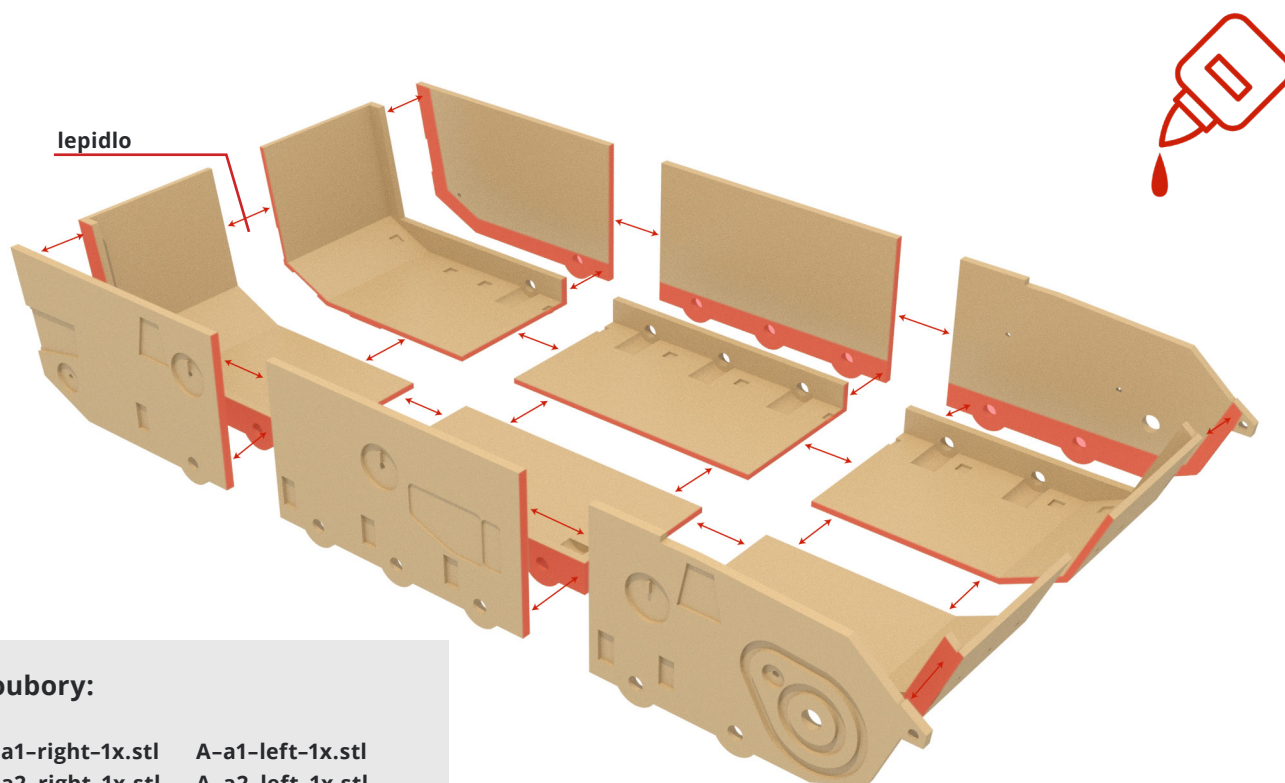
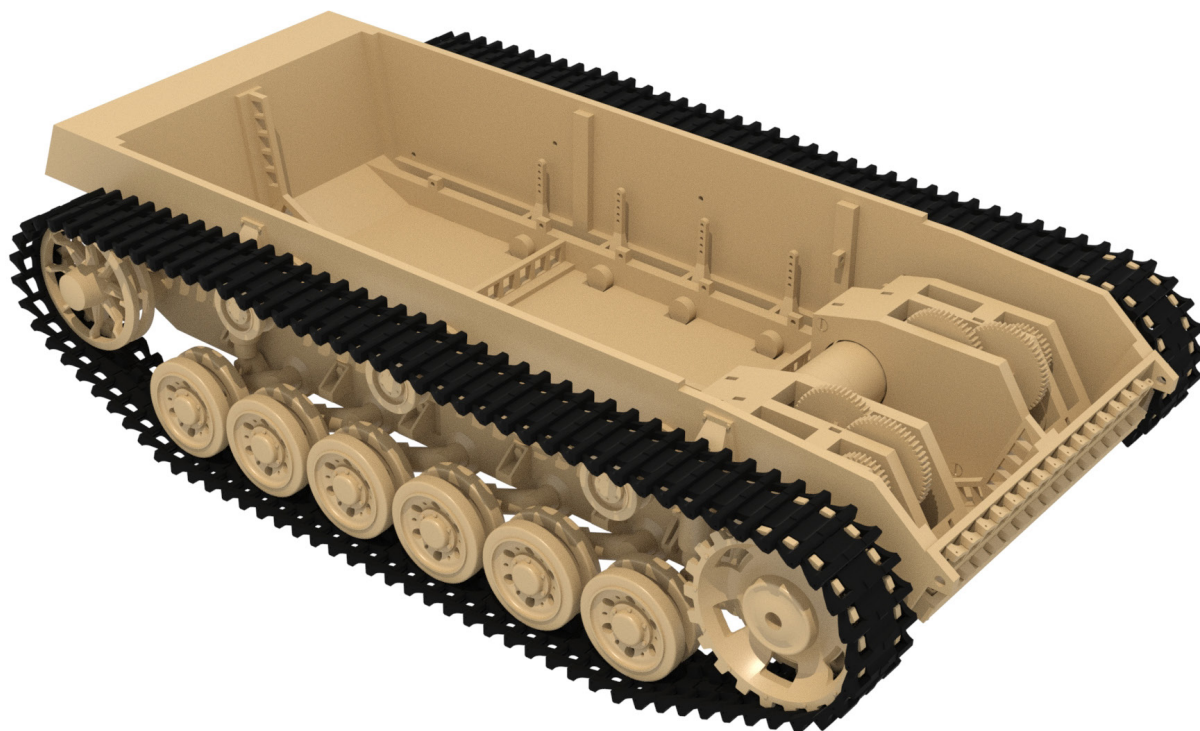

Soubory:

A-a1-right-1x.stl	A-a1-left-1x.stl
A-a2-right-1x.stl	A-a2-left-1x.stl
A-a3-right-1x.stl	A-a3-left-1x.stl
A-a4-right-1x.stl	A-a4-left-1x.stl
A-a5-right-1x.stl	A-a5-left-1x.stl
A-a6-right-1x.stl	A-a6-left-1x.stl

A

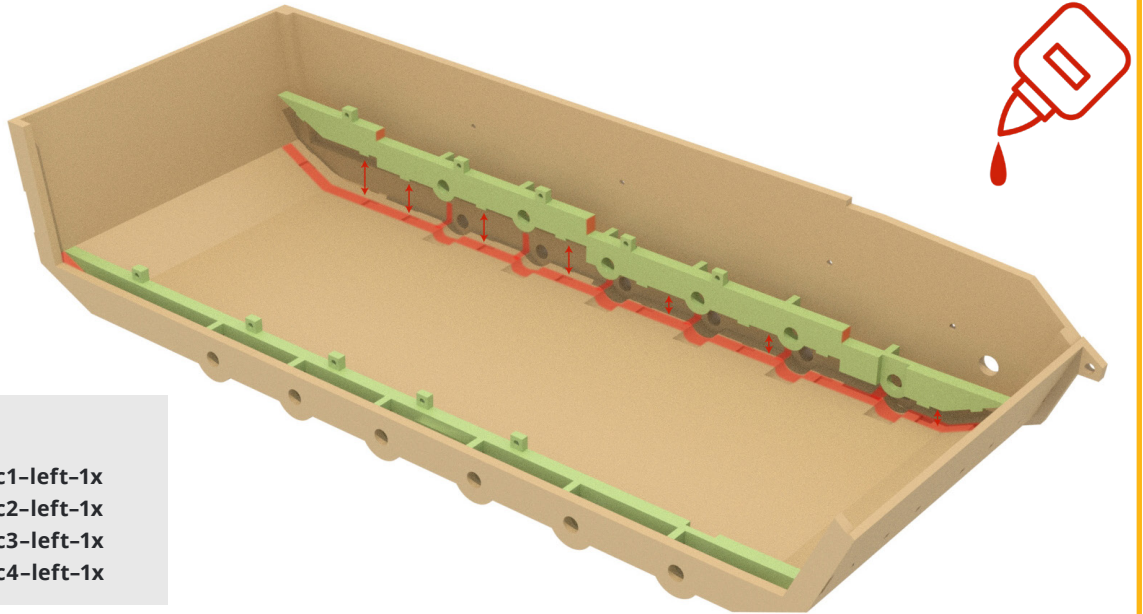

Použit lepidlo

Soubory:

- A-c1-right-1x A-c1-left-1x
- A-c2-right-1x A-c2-left-1x
- A-c3-right-1x A-c3-left-1x
- A-c4-right-1x A-c4-left-1x

Soubory:

- A-d1-center-1x
- A-d2-center-1x
- A-d3-center-1x
- A-d4-center-1x
- A-d5-center-1x
- A-d6-center-1x

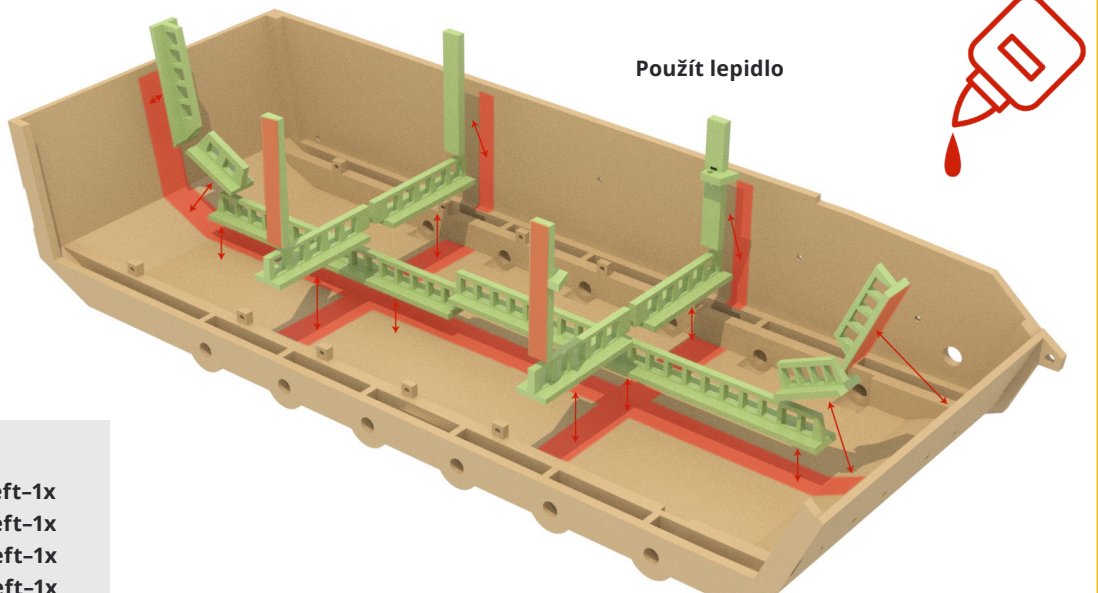

Použit lepidlo

Soubory:

- A-d1-right-1x A-d1-left-1x
- A-d2-right-1x A-d2-left-1x
- A-d3-right-1x A-d3-left-1x
- A-d4-right-1x A-d4-left-1x

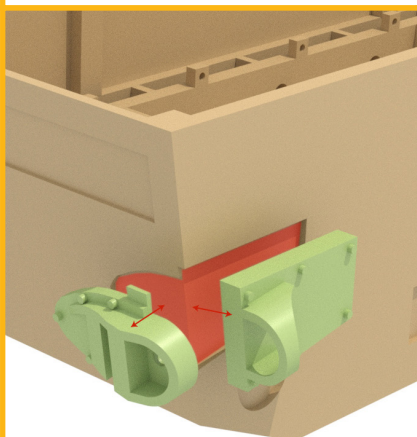

Použit lepidlo

Soubory:

- A-e1-right-1x
- A-e1-left-1x
- A-e2-right-1x
- A-e2-left-1x

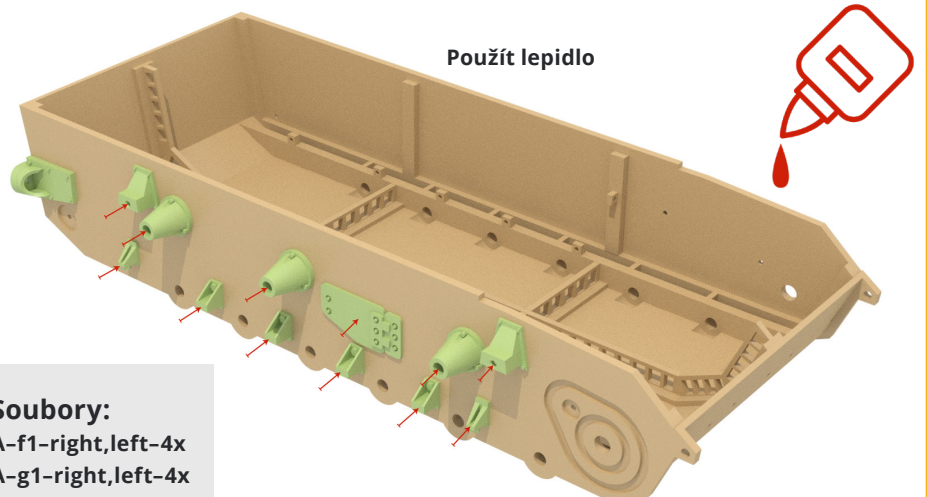

Použit lepidlo

Soubory:

- A-f1-right, left-4x
- A-g1-right, left-4x
- A-h1-right, left-8x
- A-i1-right, left-6x
- A-j1-right-1x
- A-j1-left-1x

Soubory:

- A-k1-right-4x
- A-k1-left-4x
- A-k2-1-right,left-10x
- A-k2-2-right,left-2x
- A-k3-right, Left-12x
- A-k4-right-6x
- A-k4-left-6x
- A-k5-1-right,left-10x
- A-k5-2-right,left-2x
- A-k6-right-2x
- A-k6-left-2x

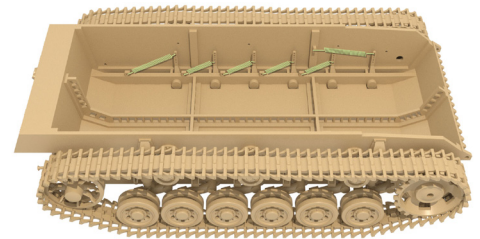
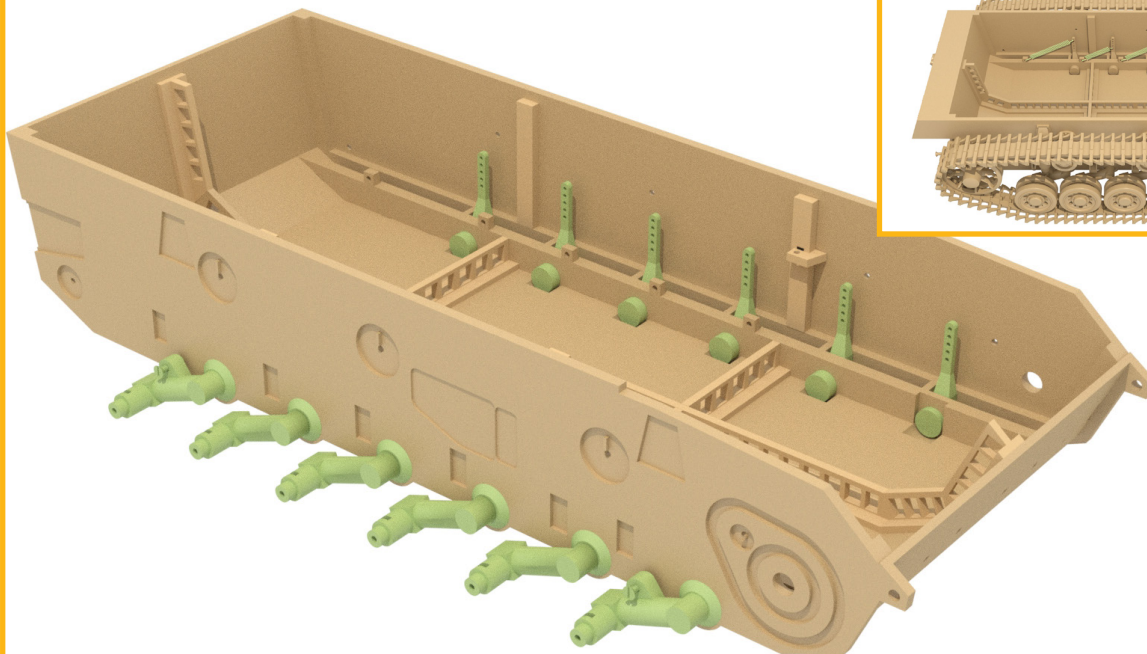
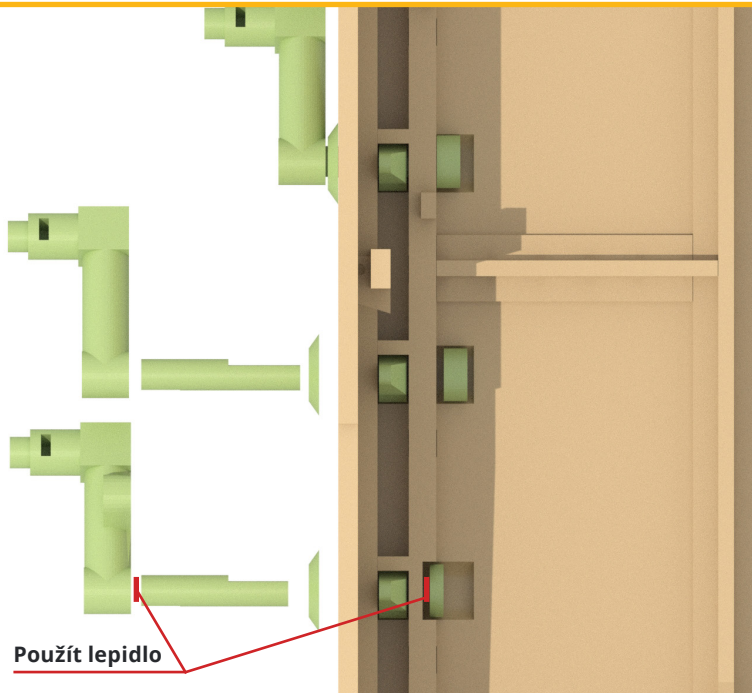

Použít lepidlo

**Soubory:**

- A-l1-right,left-4x
- A-l2-right,left-4x

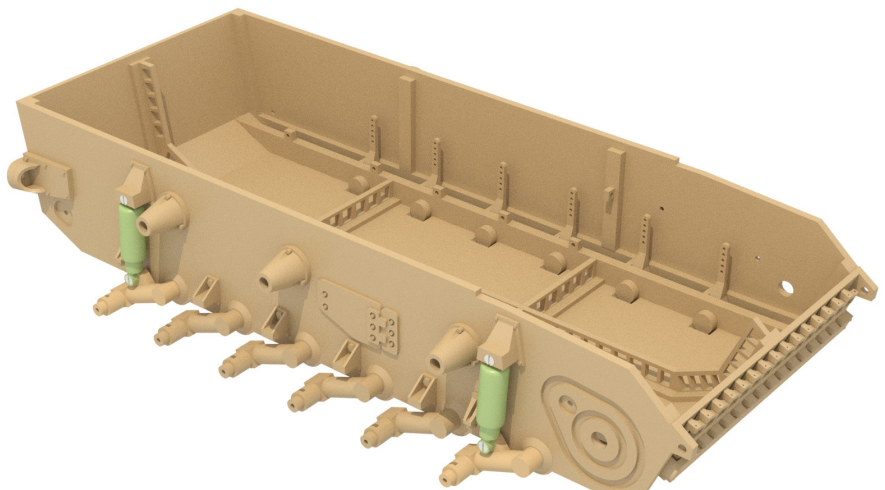
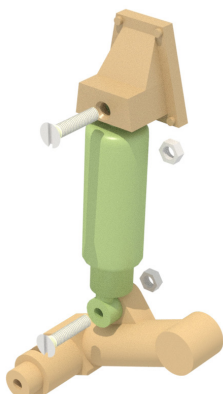

A

Soubory:

A-m1-right, left-12x
A-m2-right, left-12x

Použit lepidlo

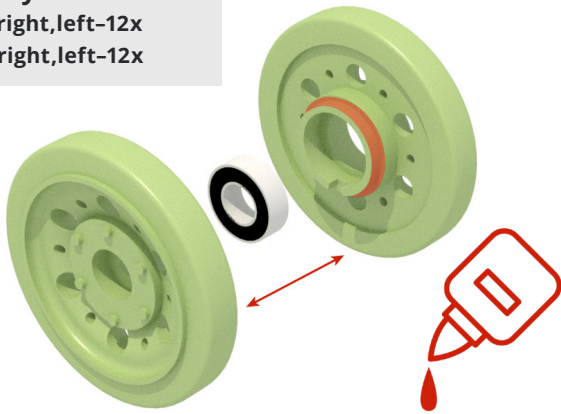

Soubory:

A-m3-right, left-12x

Použit lepidlo

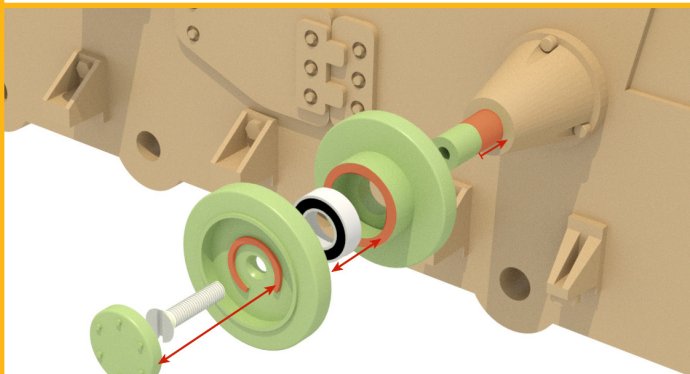
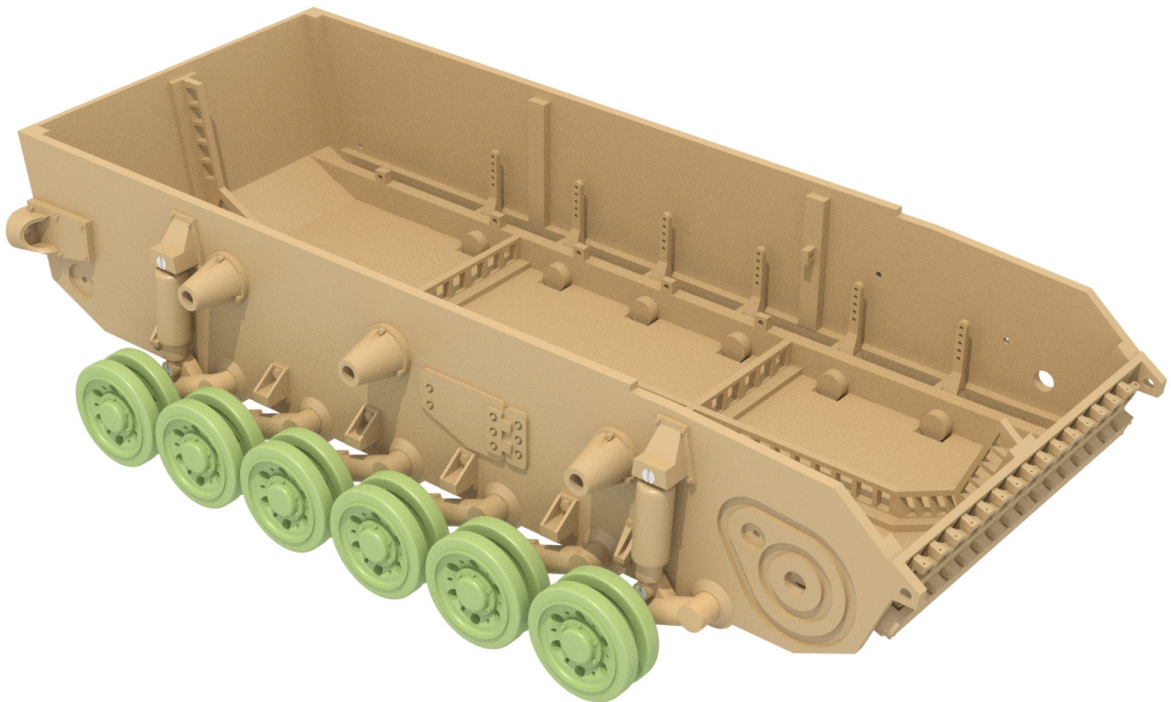
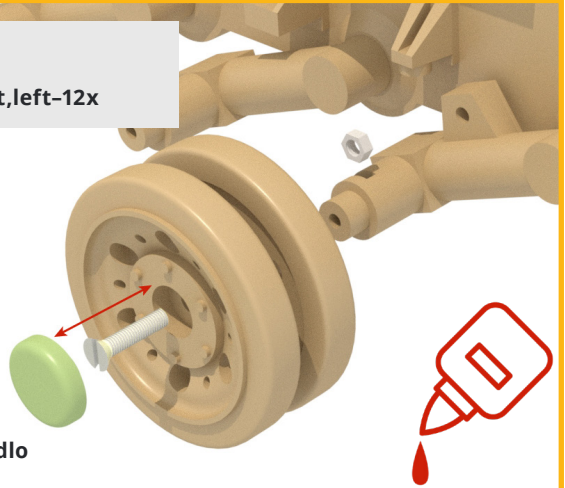

Použit lepidlo

Soubory:

A-n1-right, left-6x
A-n2-right, left-6x
A-n3-right, left-6x
A-n4-right, left-6x

Ložisko 7x13x4mm - 12x

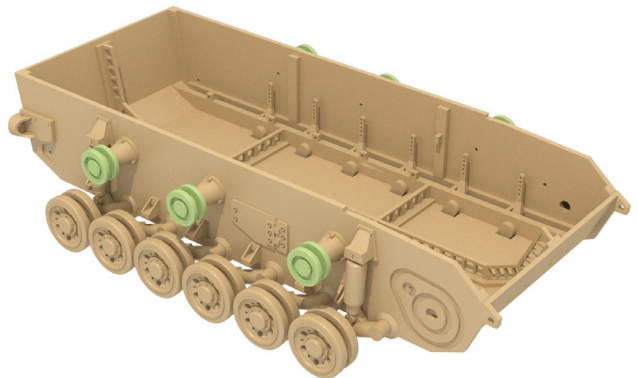

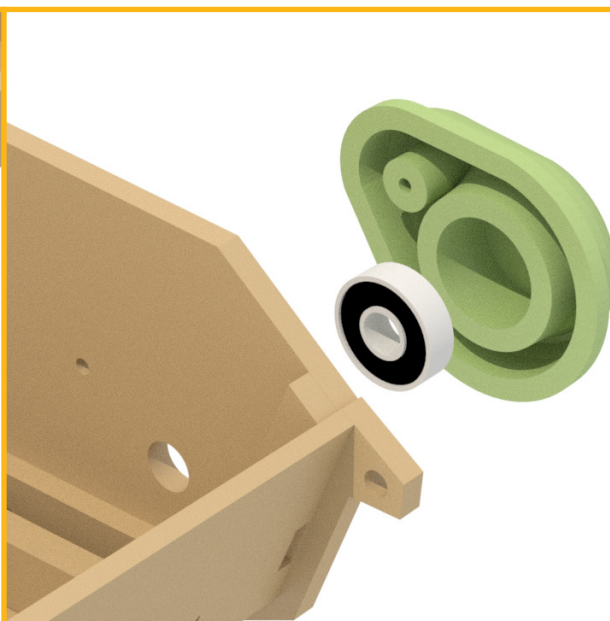
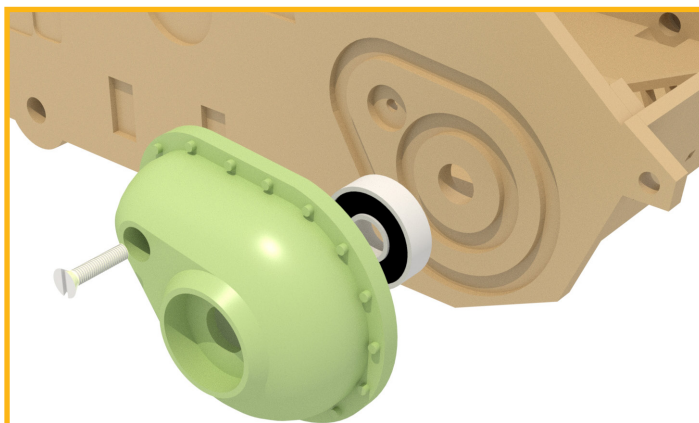
**Soubory:**

A-o1-right, left-2x

Ložisko 9x7x24mm - 2x

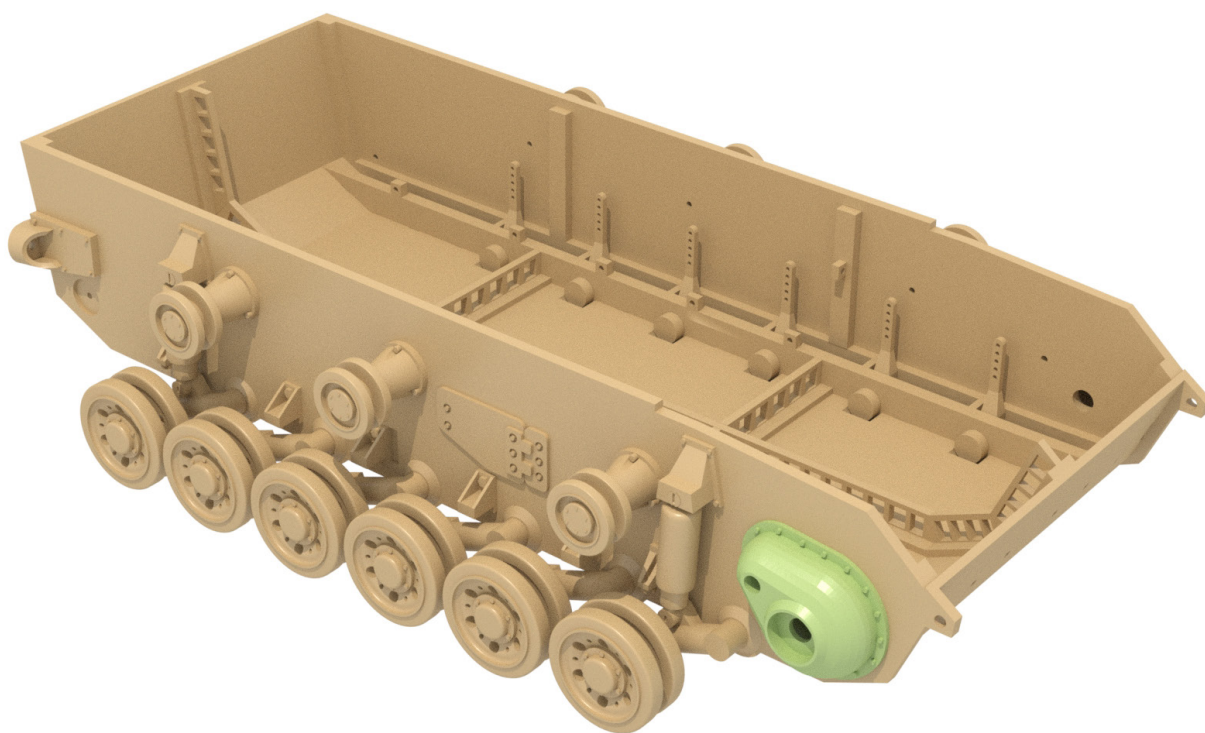

Použít lepidlo

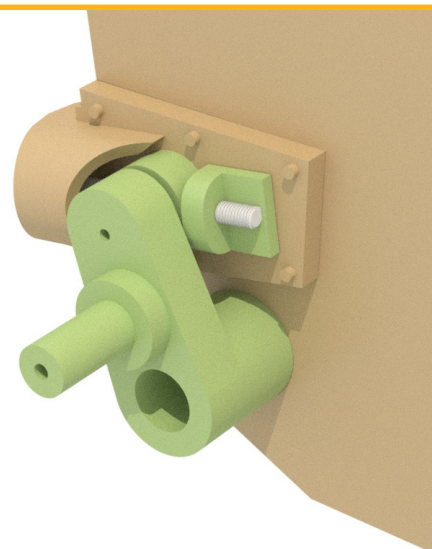
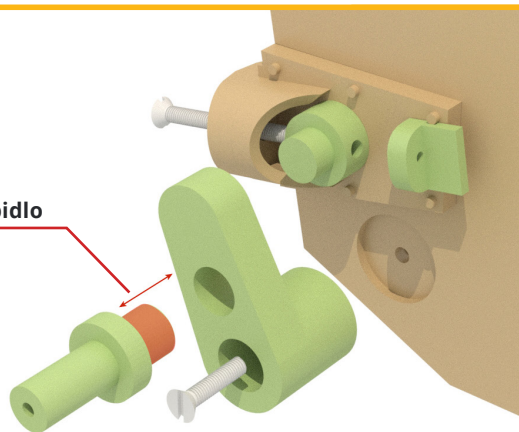
**Soubory:**

A-p1-right, left-2x

A-p2-right, left-2x

A-p3-right, left-2x

A-p4-right, left-2x

A

Soubory:

A-q1-right,left-2x

A-q2-right,left-2x

A-q3-right,left-2x

Ložisko 8x5x16mm - 4x

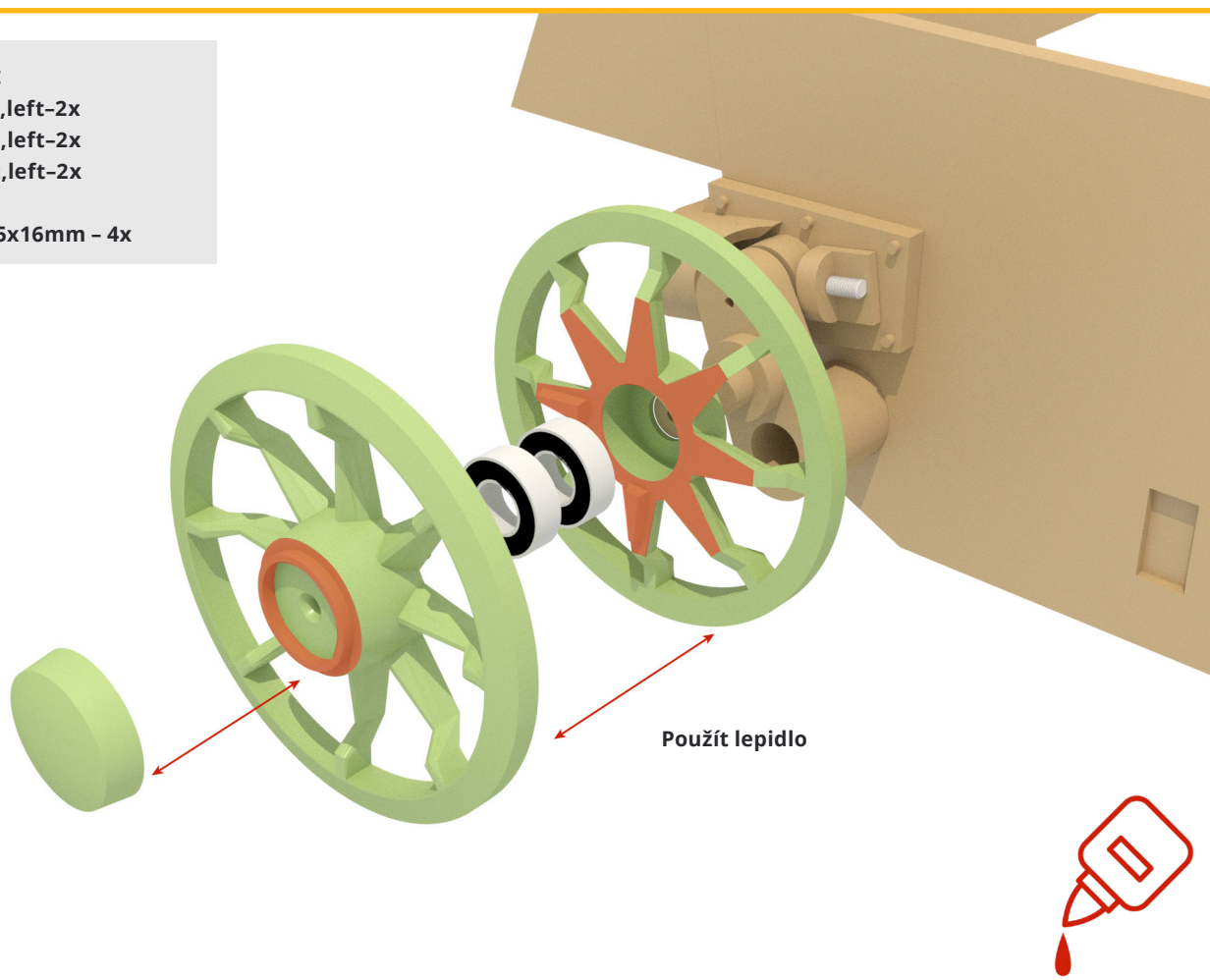

P

Soubory:

P-a1-right-1x P-a2-left-1x

P-a1-left-1x P-a3-right-1x

P-a2-right-1x P-a3-left-1x

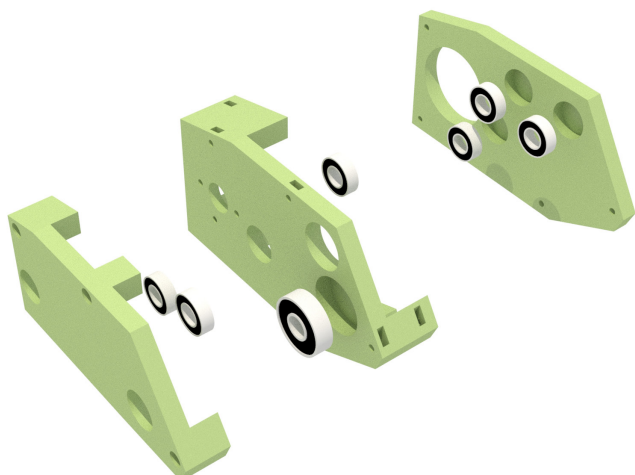

Soubory:

P-b1-right,left-2x

P-b2-right,left-2x

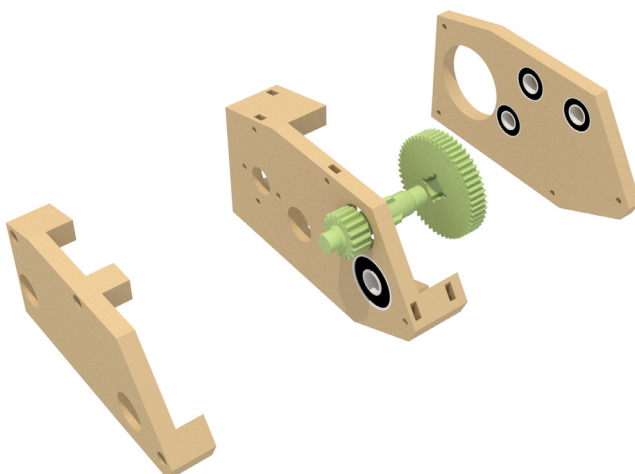

Soubory:

- P-b3-right,left-2x
- P-b4-right,left-2x
- P-b5-right,left-2x
- P-b6-right,left-2x

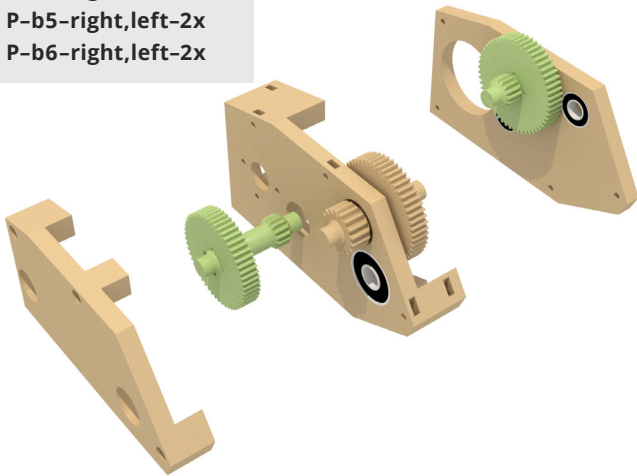

Soubory:

- P-b7-right,left-2x
- P-b8-right,left-2x

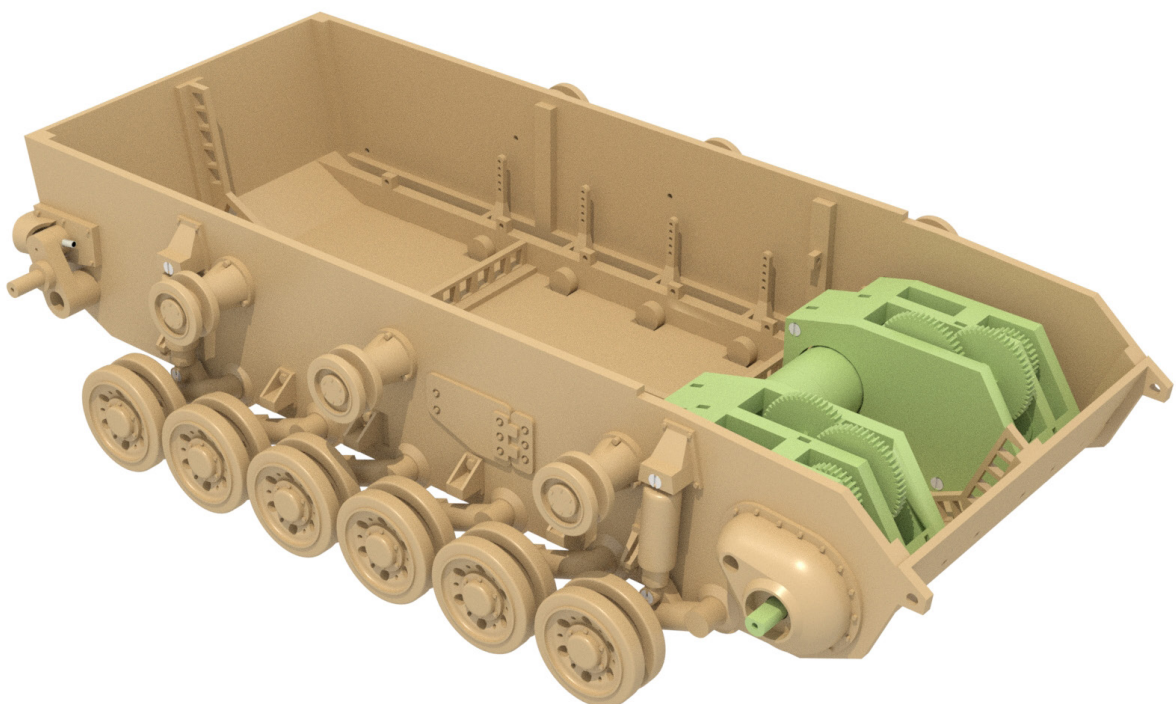
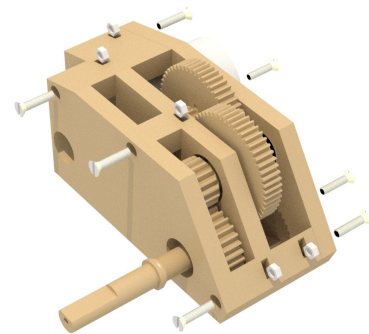
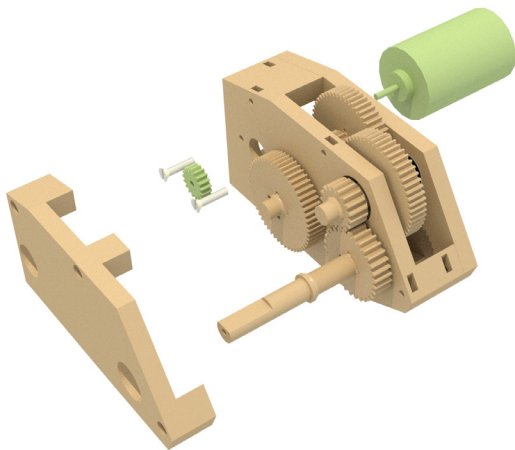
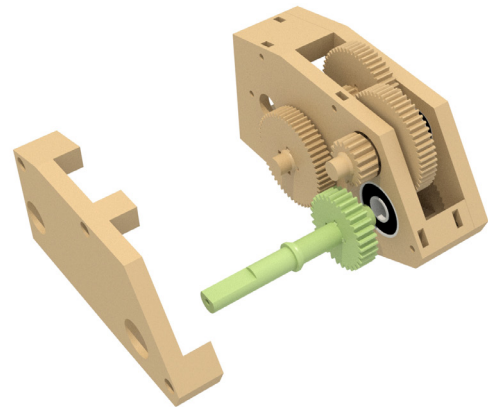

A

Soubory:

- A-r1-right, left-2x
- A-r2-right, left-2x
- A-r3-right, left-2x

Použit lepidlo

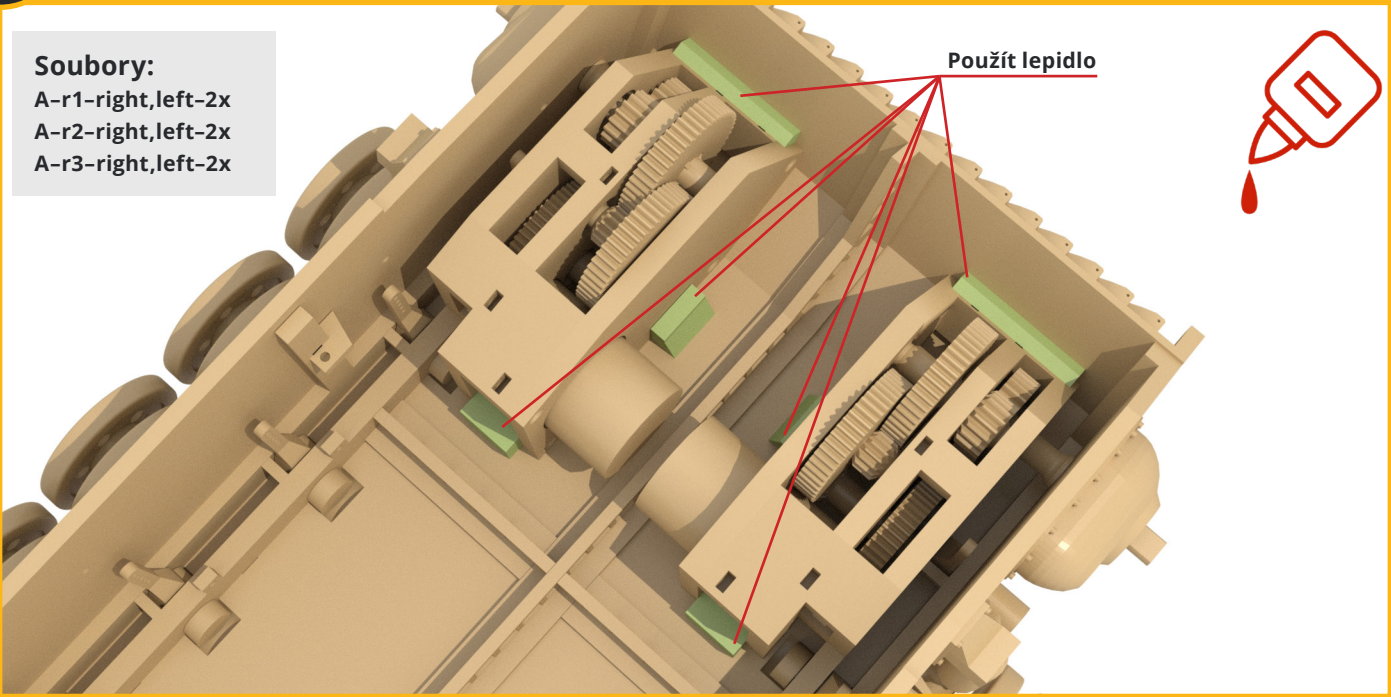

Soubory:

- A-t1-right, left-2x
- A-t2-right, left-2x
- A-t3-right, left-2x

Použit lepidlo

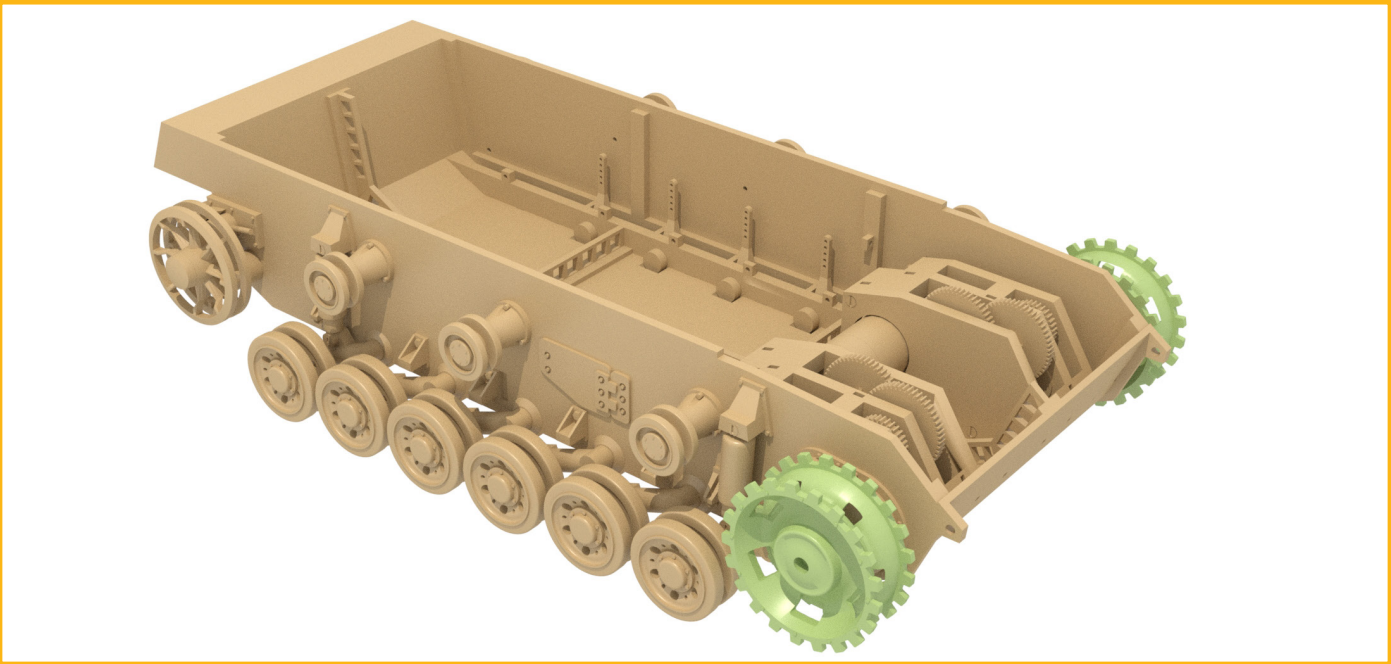
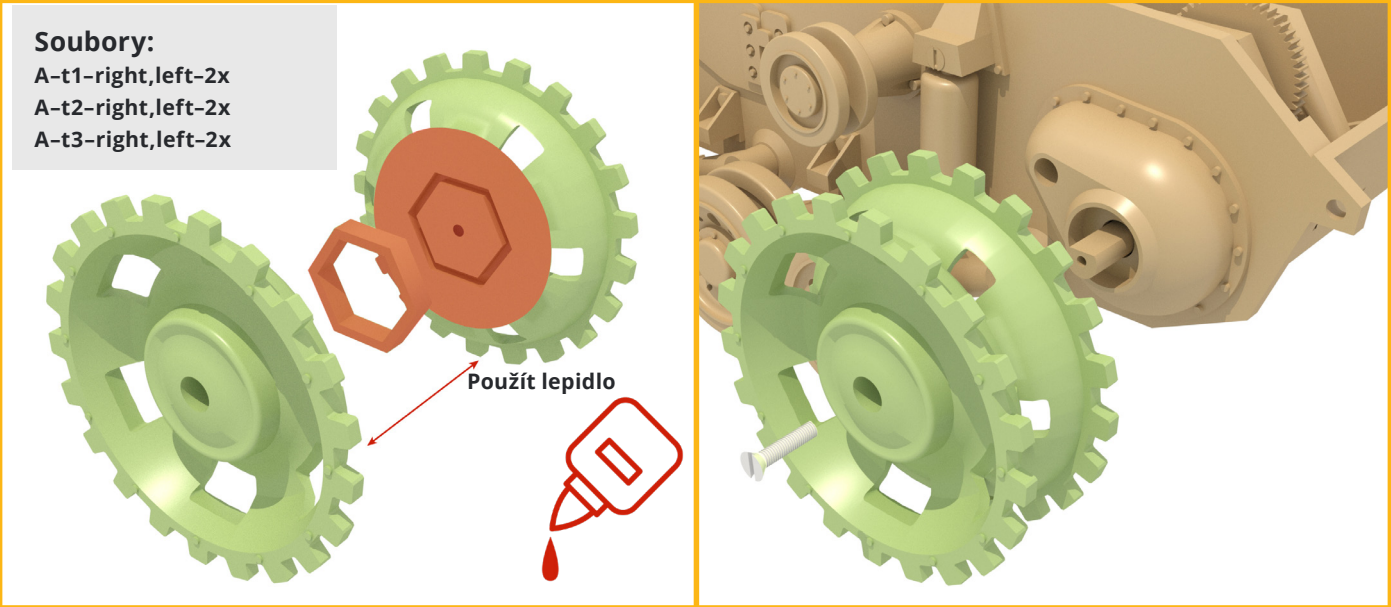

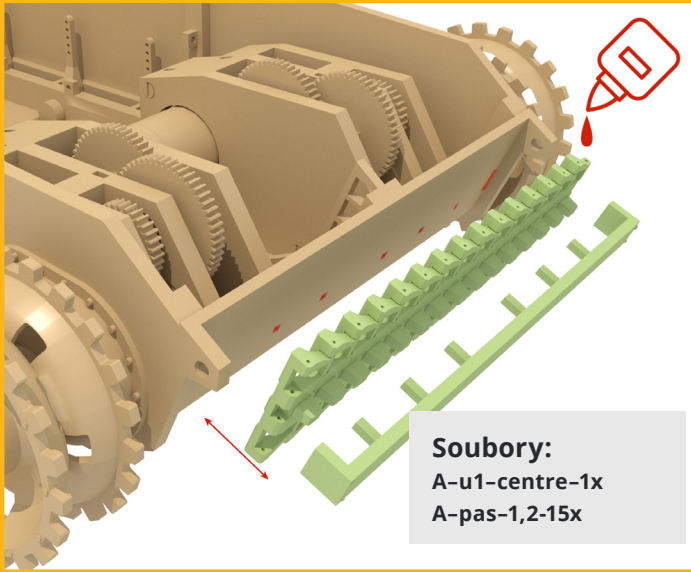

Soubory:
 A-u1-centre-1x
 A-pas-1,2-15x

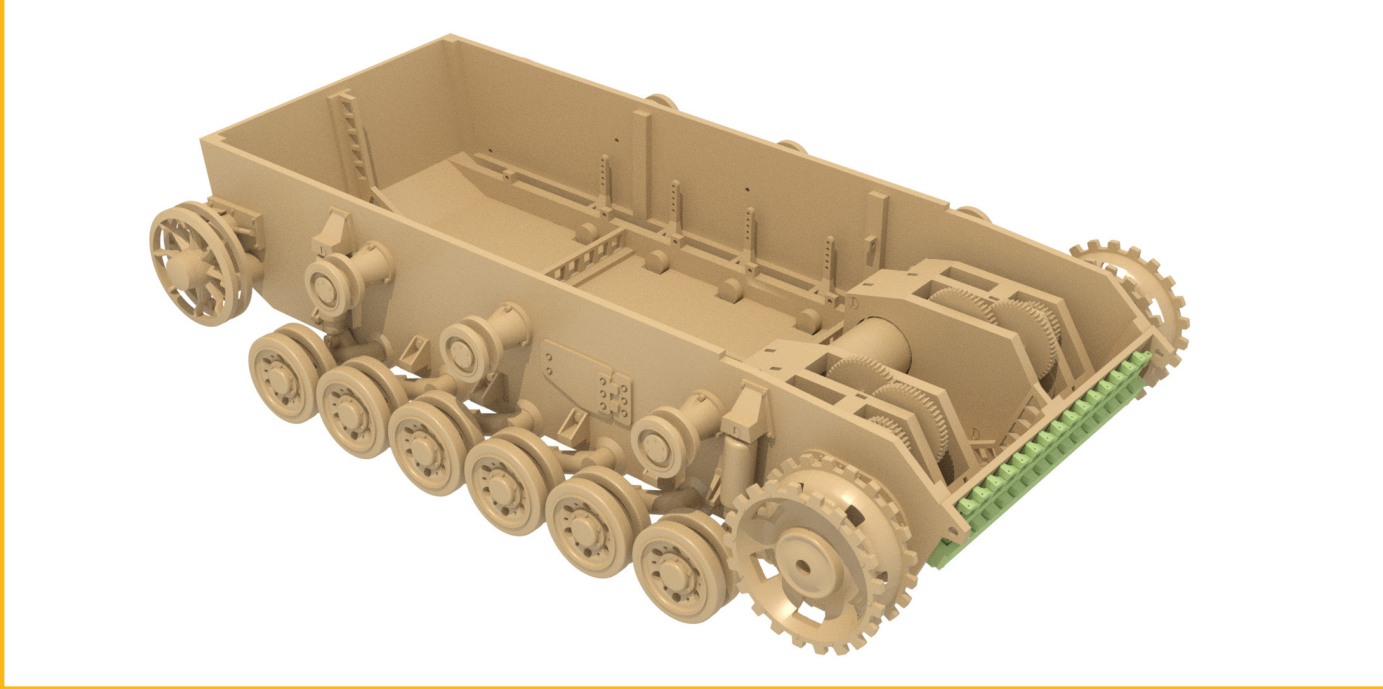
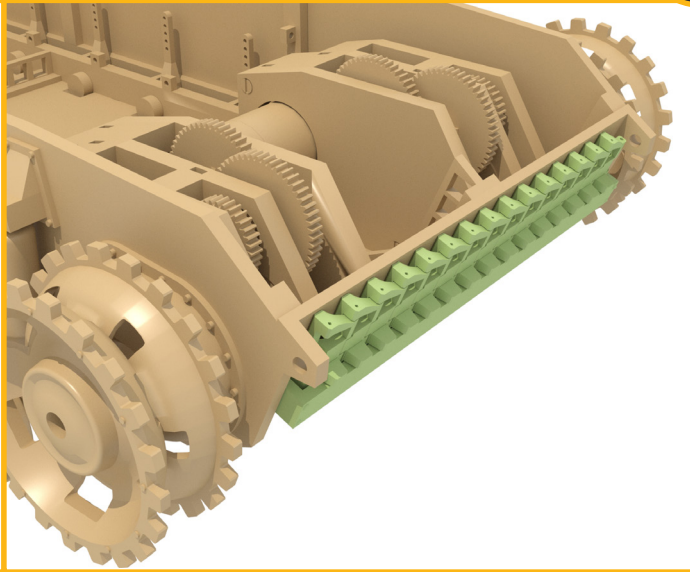

Soubory:
 A-v1-right-1x
 A-v2-right-1x
 A-v3-right-1x
 A-v4-right-1x
 A-v1-left-1x
 A-v2-left-1x
 A-v3-left-1x
 A-v4-left-1x

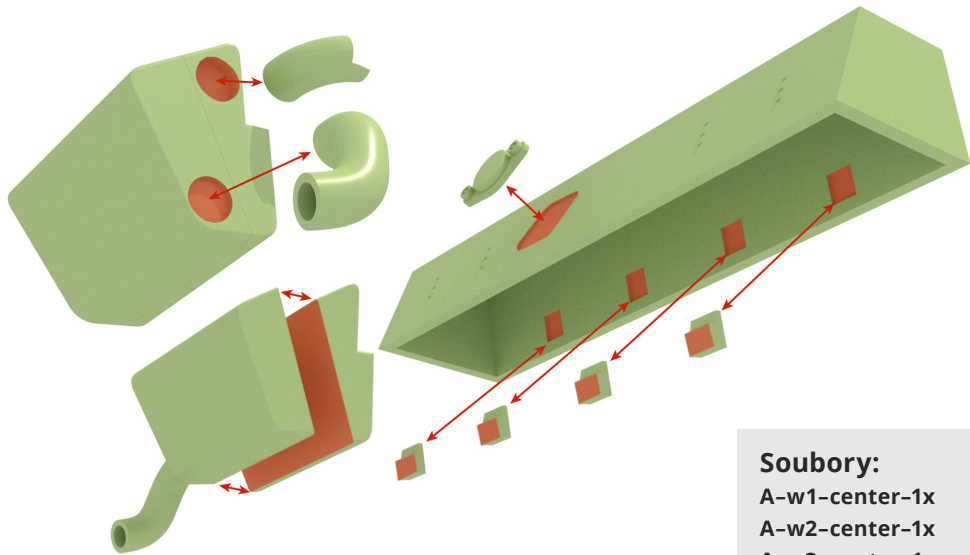

Soubory:
 A-w1-center-1x
 A-w2-center-1x
 A-w3-center-1x



A

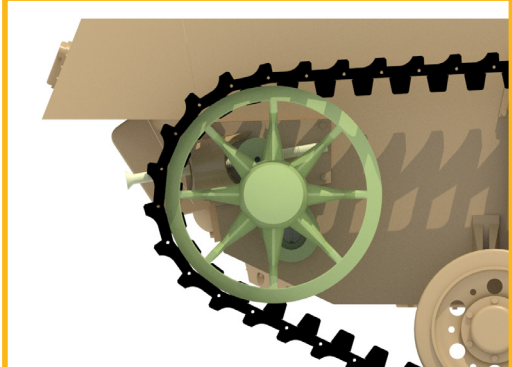
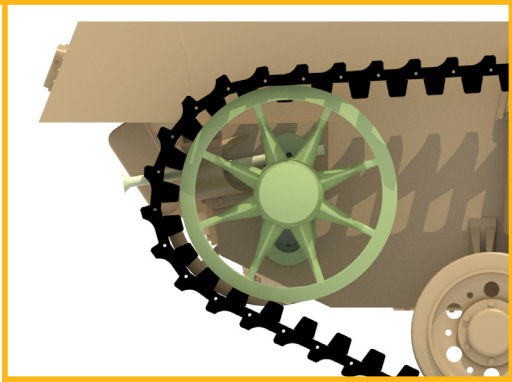
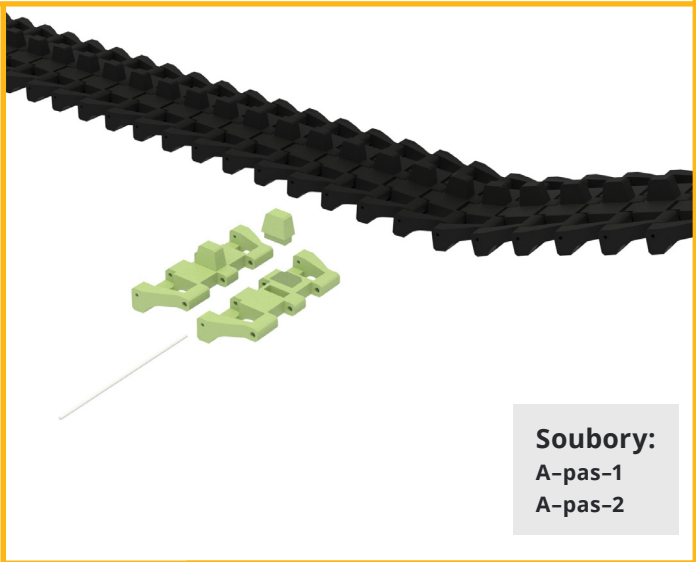
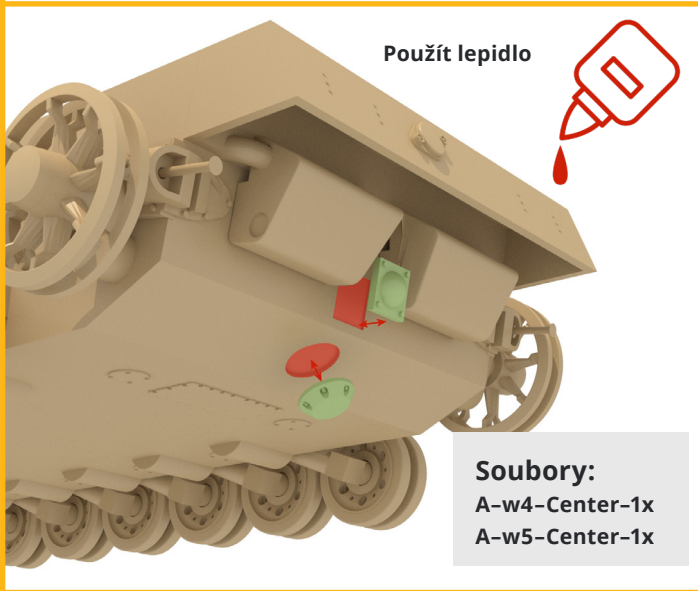
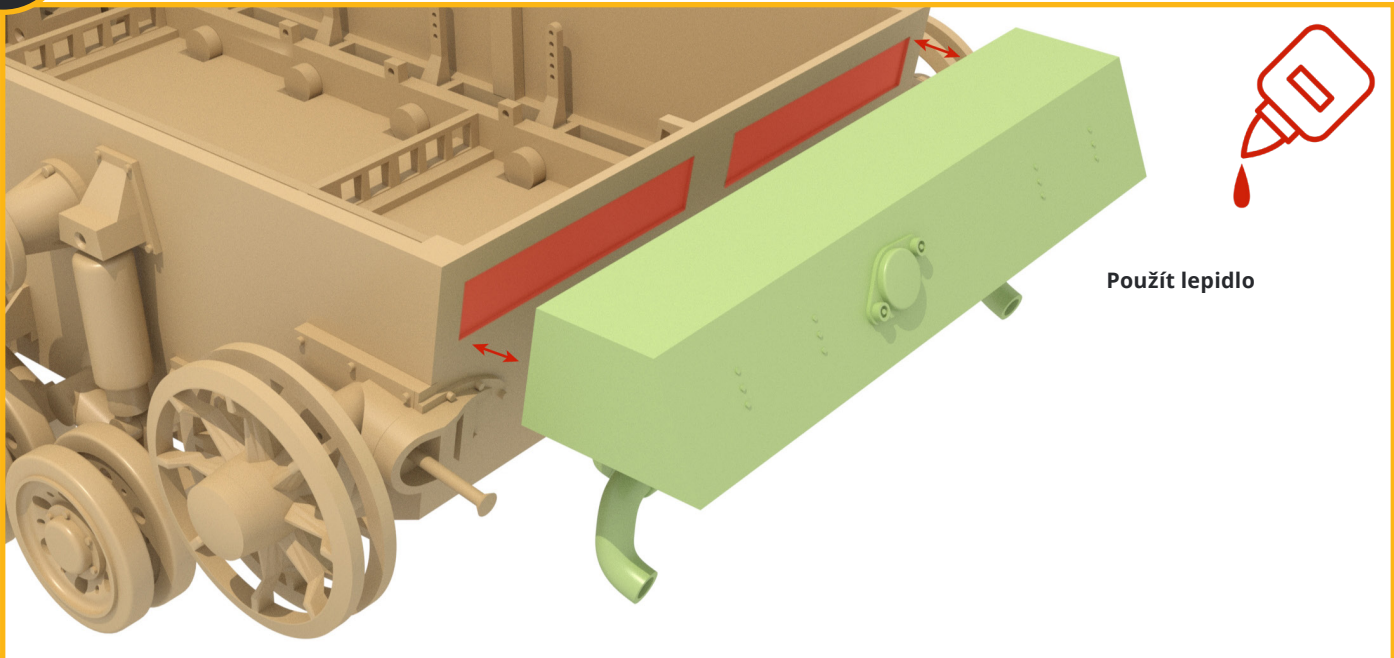

B



Soubory:

- | | |
|----------------------|------------------|
| B-a1-center-1ks | B-a5-center-1ks |
| B-a2-center-1ks | B-a5-1-right-1ks |
| B-a2-right, left-2ks | B-a5-2-right-1ks |
| B-a3-center-1ks | B-a5-1-left-1ks |
| B-a4-center-1ks | B-a5-2-left-1ks |
| B-a4-right-1ks | B-a6-center-1ks |
| B-a4-left-1ks | |

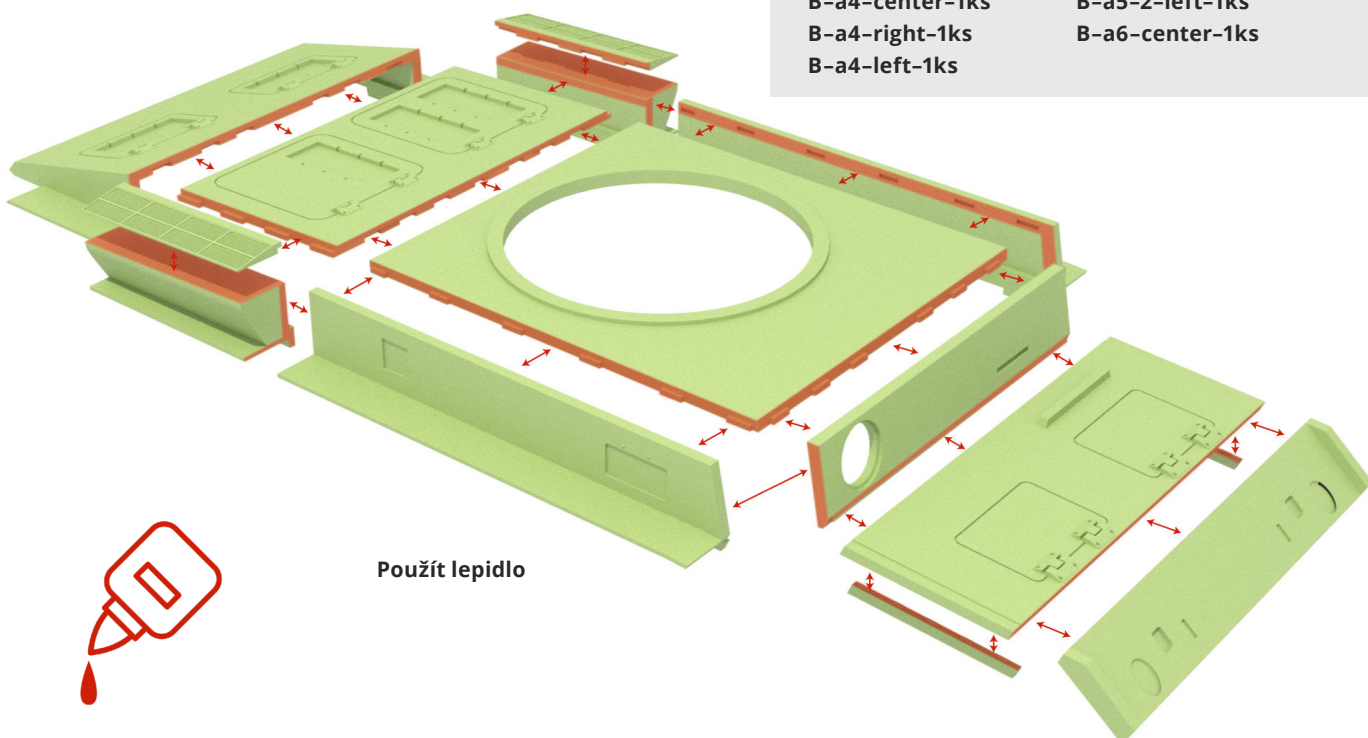

Použit lepidlo

B

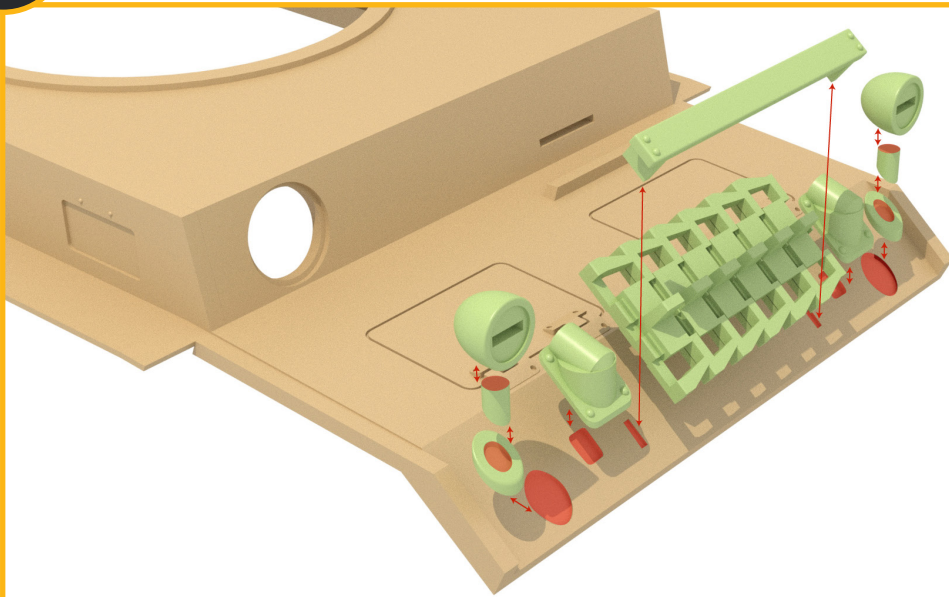

- Soubory:**
 B-a1-1-center-1ks
 B-a1-2-center-1ks
 A-pas-1,2-6ks
 B-a1-3-right,left-2ks
 B-a1-4-right,left-2ks
 B-a1-5-right,left-2ks
 B-a1-6-right,left-2ks

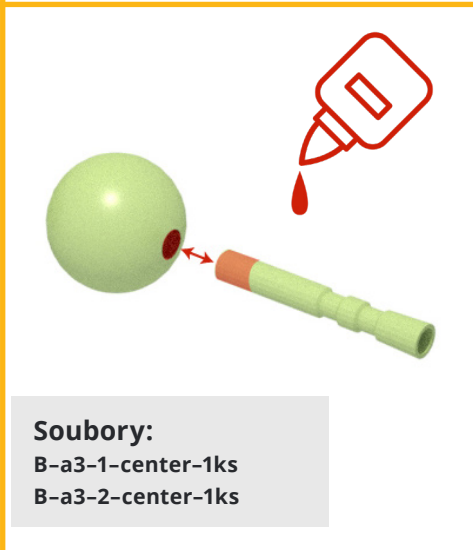

- Soubory:**
 B-a3-1-center-1ks
 B-a3-2-center-1ks

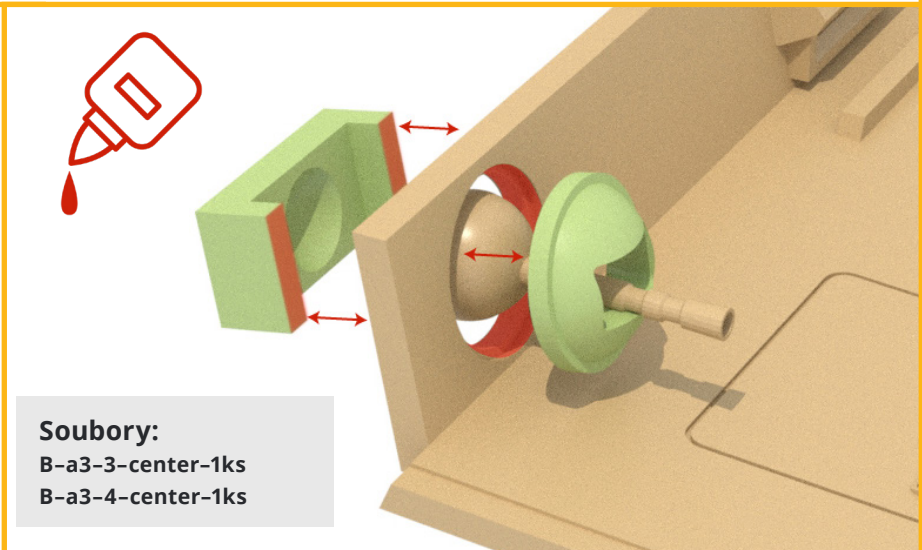

- Soubory:**
 B-a3-3-center-1ks
 B-a3-4-center-1ks

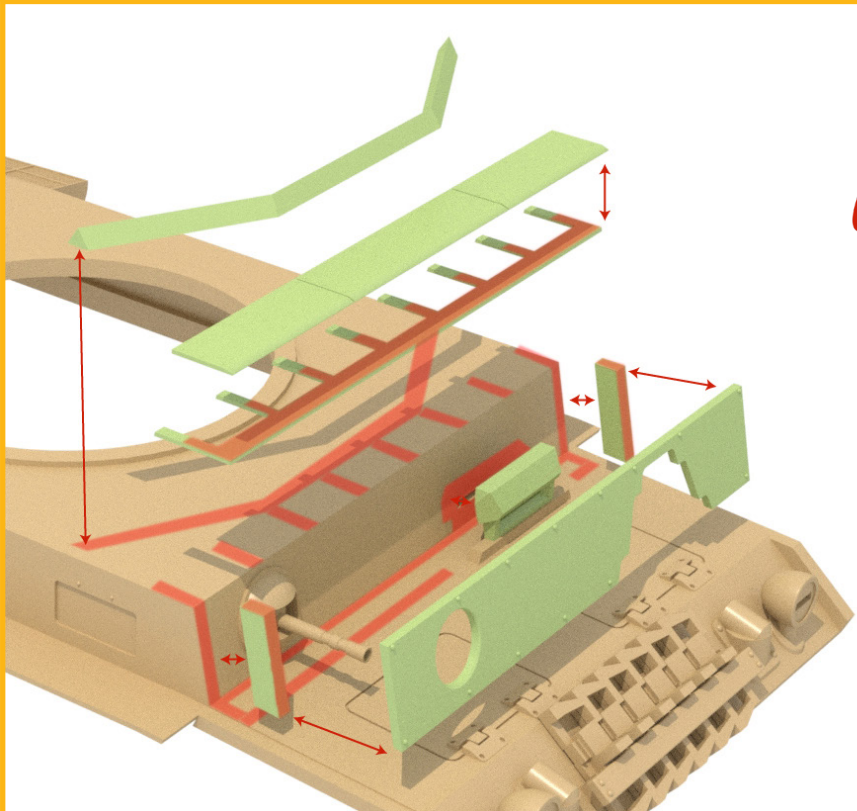

- Soubory:**
 B-a3-5-center-1ks
 B-a3-6-center-1ks
 B-a3-7-center-1ks
 B-a3-8-center-1ks
 B-a3-9-center-1ks
 B-a3-10-right,left-2ks

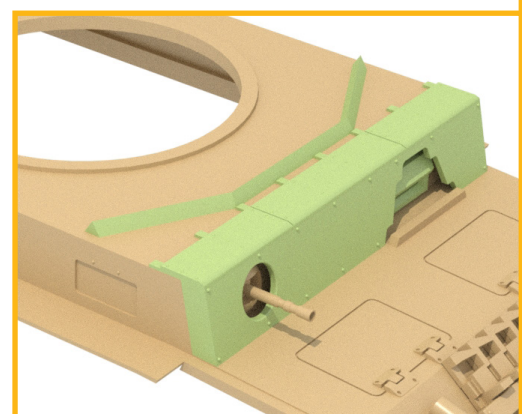

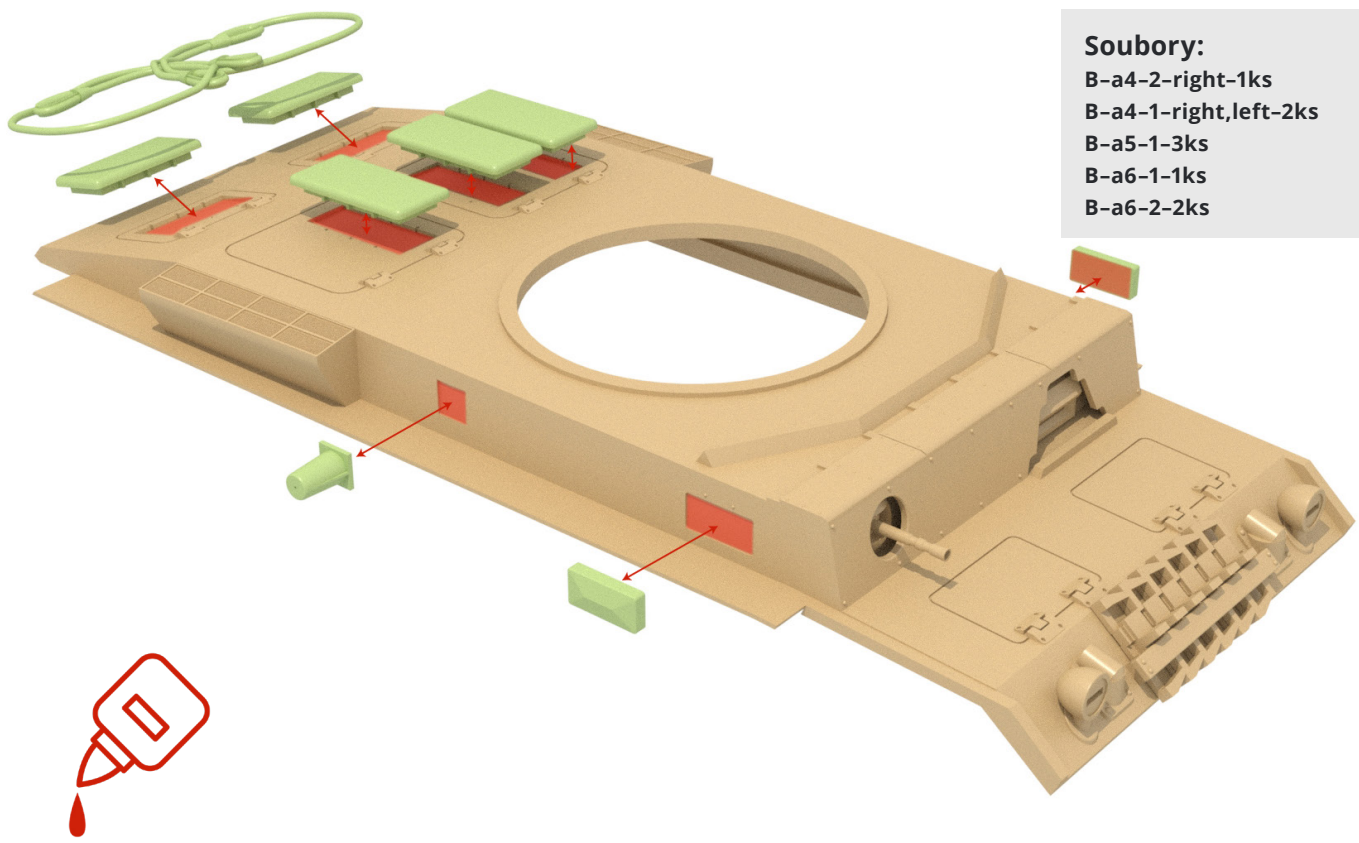

- Soubory:**
 B-a4-2-right-1ks
 B-a4-1-right,left-2ks
 B-a5-1-3ks
 B-a6-1-1ks
 B-a6-2-2ks

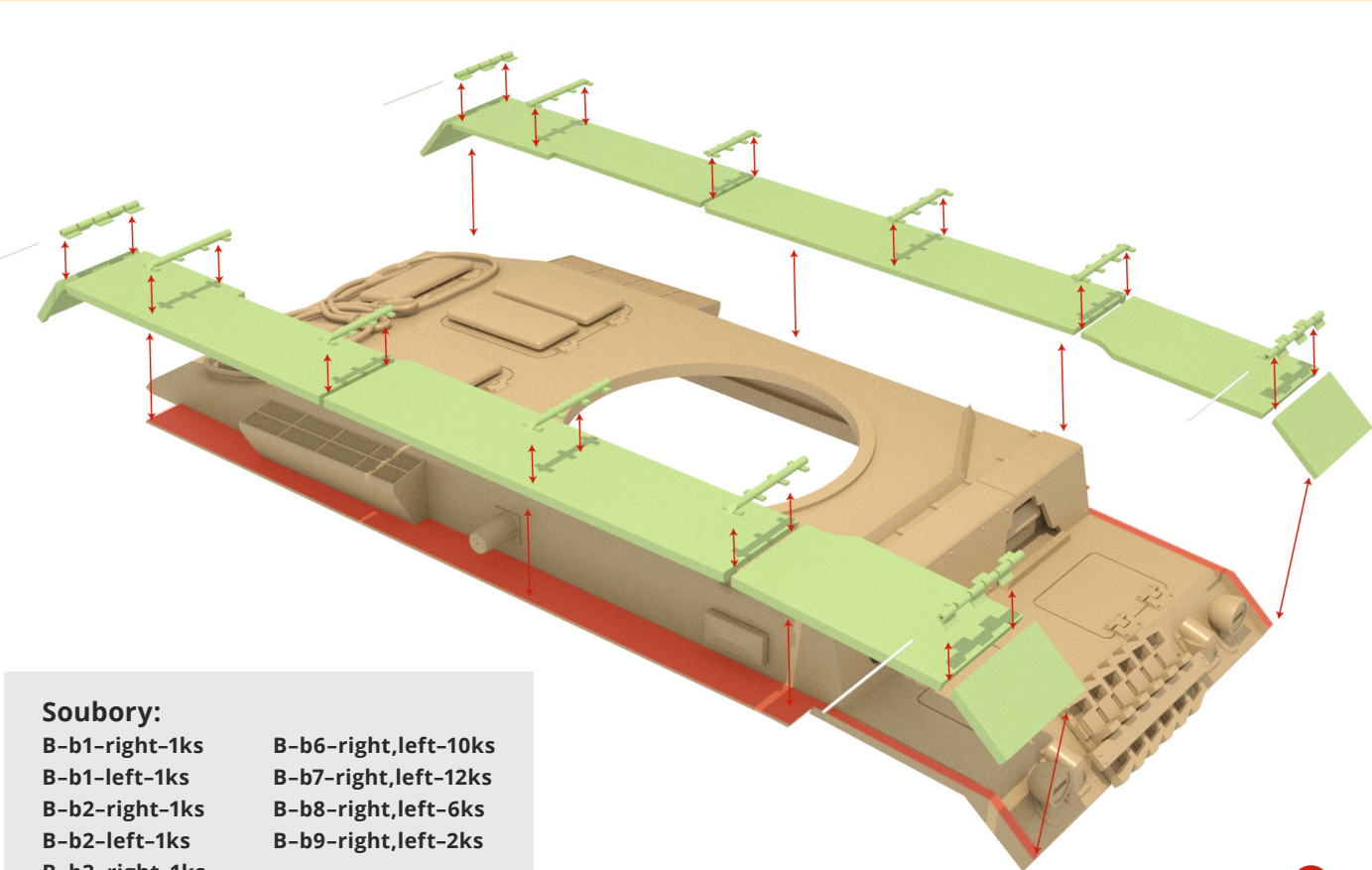

- Soubory:**
- | | |
|----------------|----------------------|
| B-b1-right-1ks | B-b6-right,left-10ks |
| B-b1-left-1ks | B-b7-right,left-12ks |
| B-b2-right-1ks | B-b8-right,left-6ks |
| B-b2-left-1ks | B-b9-right,left-2ks |
| B-b3-right-1ks | |
| B-b3-left-1ks | |
| B-b4-right-1ks | |
| B-b4-left-1ks | |
| B-b5-right-1ks | |
| B-b5-left-1ks | |



B

Soubory:

- B-c1-2ks
- B-c2-2ks
- B-c3-2ks
- B-c4-2ks
- B-c5-2ks
- B-c6-4ks



Soubory:

- B-d1-right, left-2ks
- B-d2-1ks
- B-d3-1ks
- B-d4-1ks
- B-d5-1ks
- B-d6-1ks
- B-d7-1ks
- B-d8-1ks
- B-d9-1ks
- B-d10-1ks
- B-d11-1ks
- B-d12-1ks
- B-d13-1ks

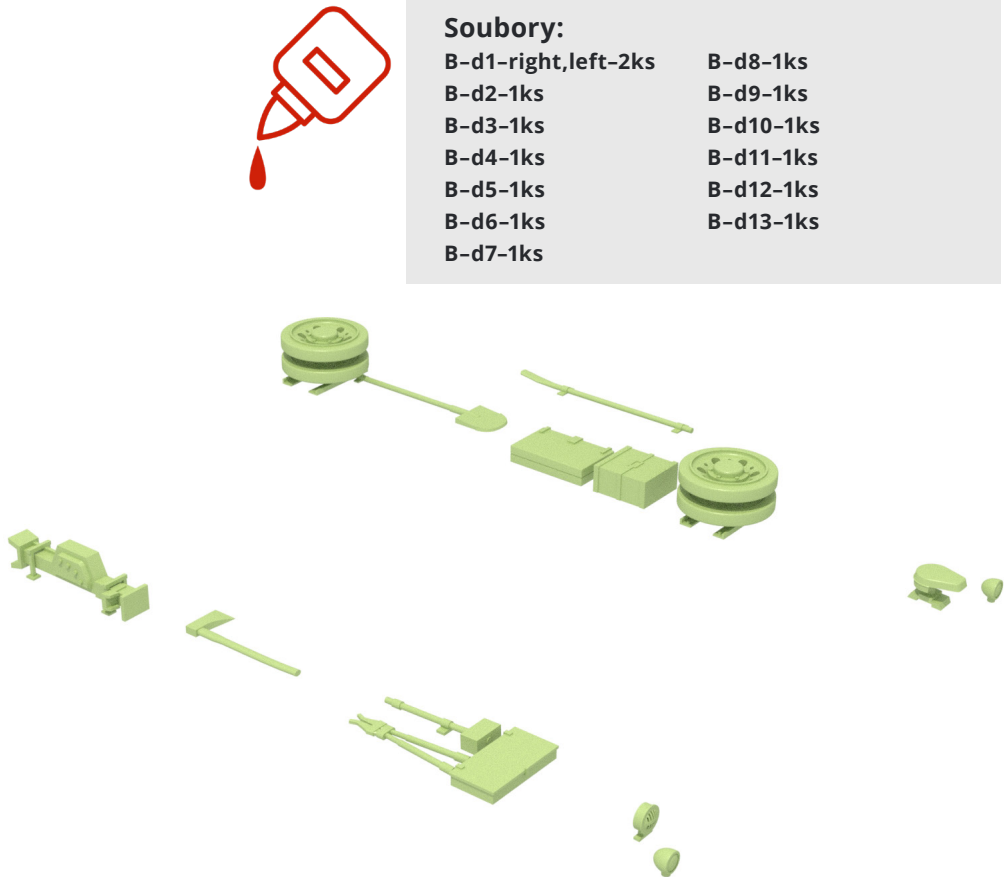

Soubory:

- B-e1-left-1ks
- B-e2-left-1ks
- B-e3-left-1ks
- B-e4-left-1ks
- B-e5-left-1ks

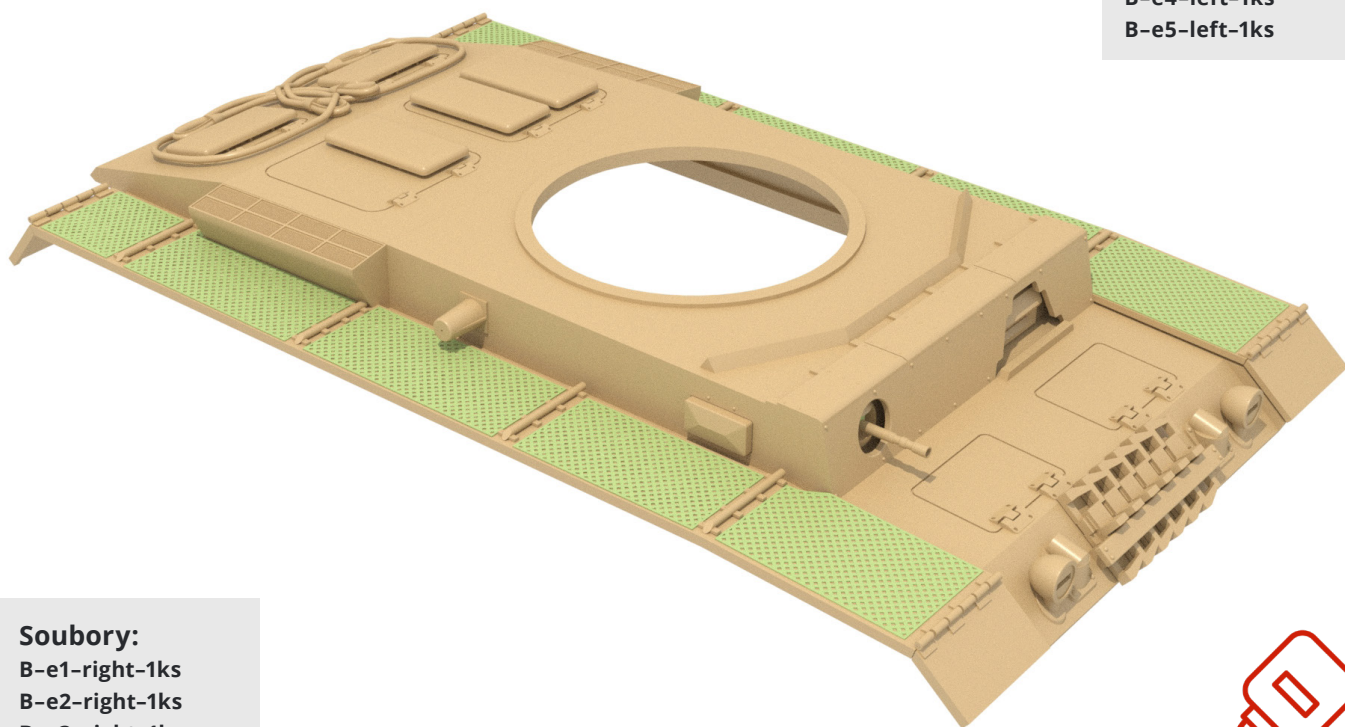

Soubory:

- B-e1-right-1ks
- B-e2-right-1ks
- B-e3-right-1ks
- B-e4-right-1ks
- B-e5-right-1ks





Soubory:

C-a1-right-1ks

C-a1-left-1ks

C-a2-1ks

C-a3-right-1ks

C-a3-left-1ks

C-a4-center-1ks

C-a5-right-1ks

C-a5-left-1ks

C-a6-1ks

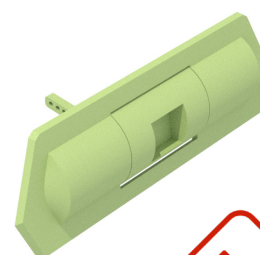
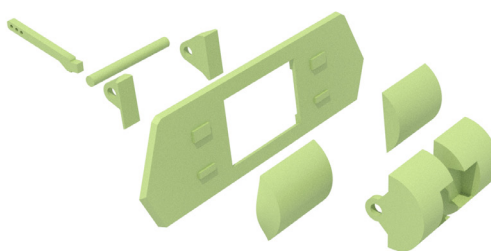
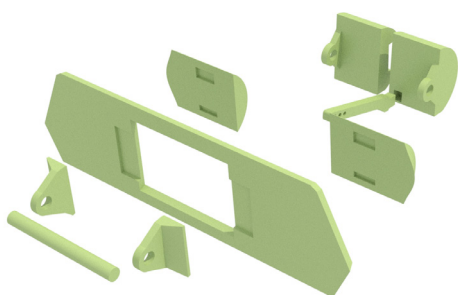

Soubory:
C-a4-1-1ks
C-a4-2-1ks

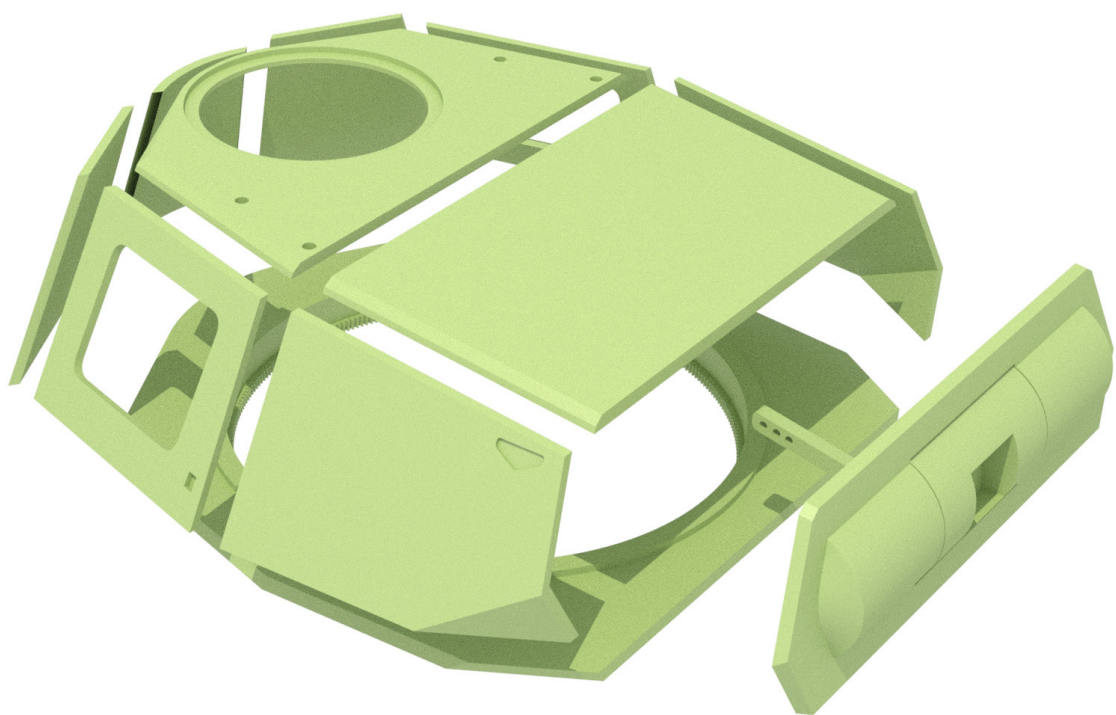
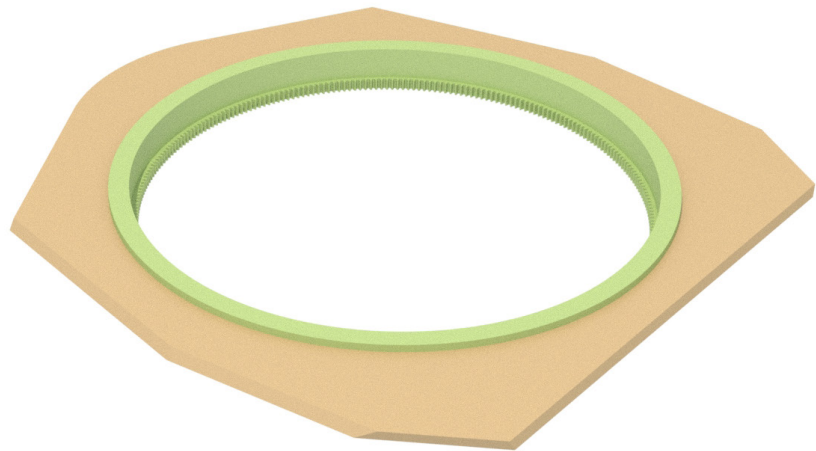

Soubory:
C-a4-3-1ks
C-a4-4-1ks
C-a4-5-1ks
C-a4-6-1ks
C-a4-7-1ks
C-a4-8-1ks
C-a4-9-1ks
C-a4-10-1ks
C-a4-11-1ks



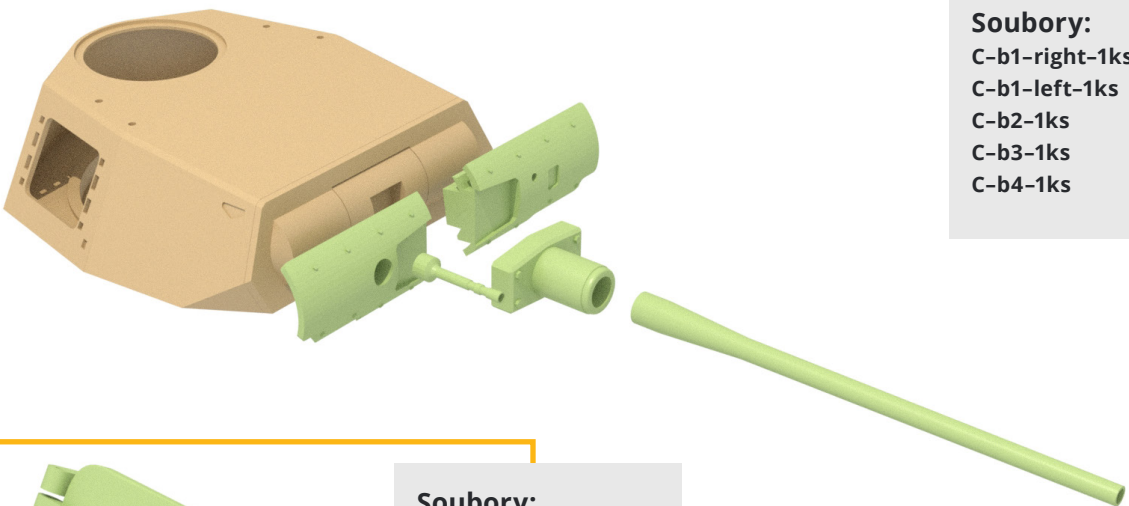

- Soubory:**
C-b1-right-1ks
C-b1-left-1ks
C-b2-1ks
C-b3-1ks
C-b4-1ks

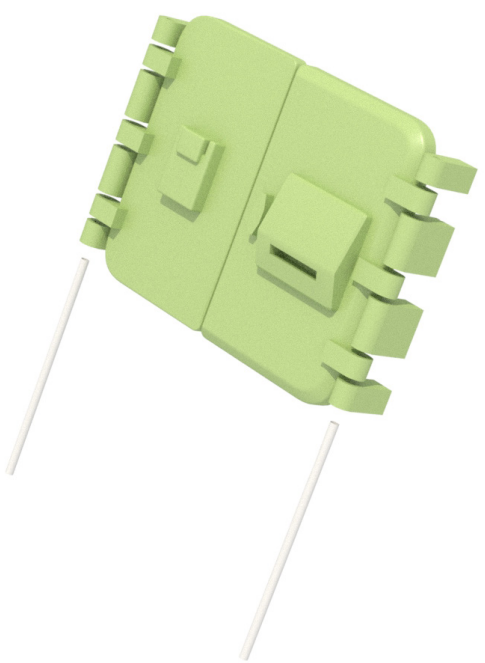

- Soubory:**
C-c1-right,left-4ks
C-c2-right,left-4ks
C-c3-right-1ks
C-c3-left-1ks
C-c4-right-1ks
C-c4-left-1ks
C-c5-2ks
C-c6-2ks
C-c7-2ks

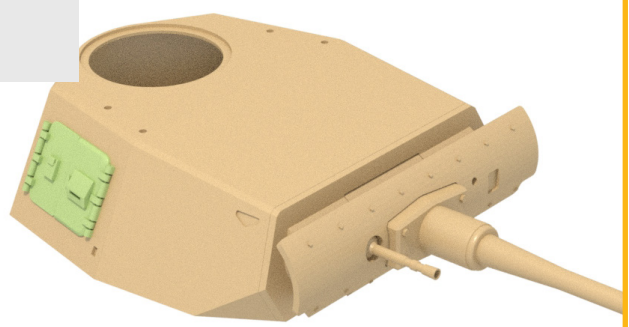

- Soubory:**
C-d1-right-1ks
C-d1-left-1ks
C-d2-1ks
C-d3-1ks
C-d4-1ks
C-d5-1ks



Soubory:
C-e1-1ks

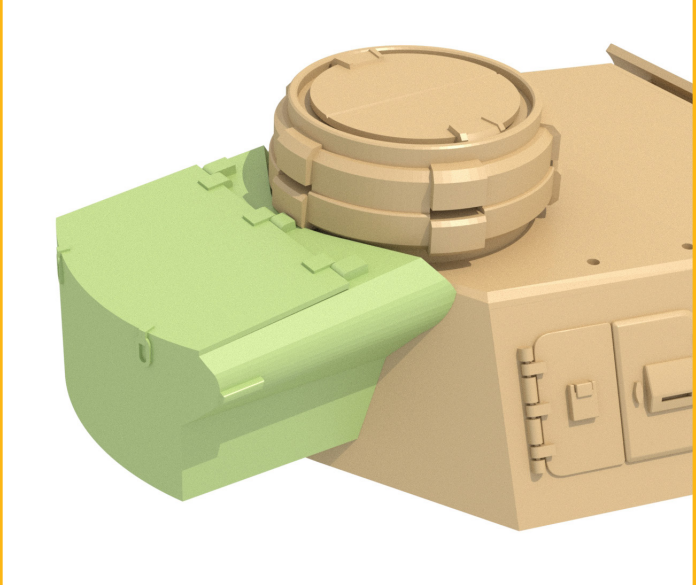
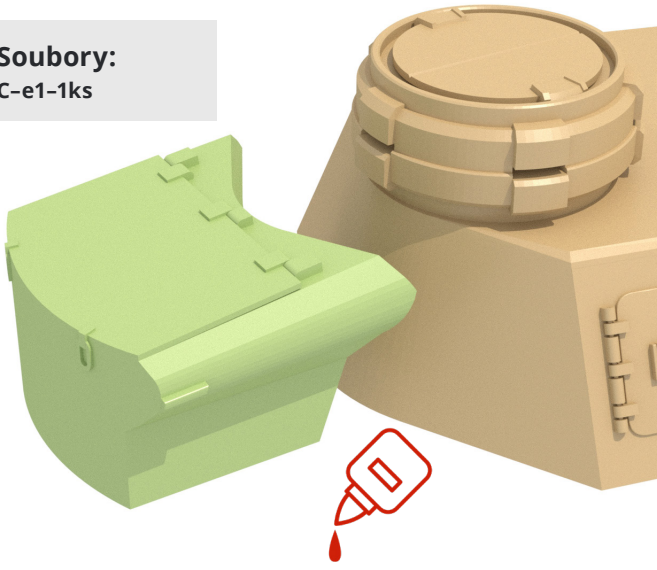

Soubory:
C-f1-1ks C-f5-2ks
C-f2-1ks C-f6-2ks
C-f3-2ks C-f7-2ks
C-f4-2ks

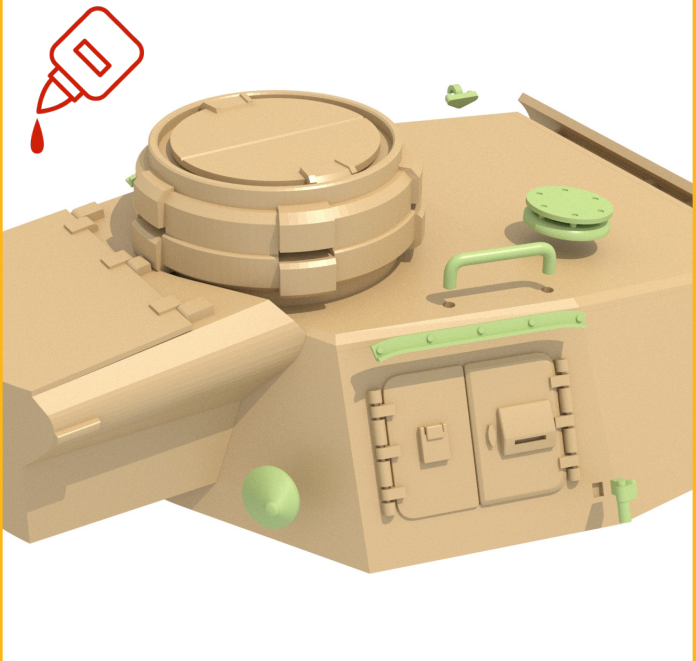
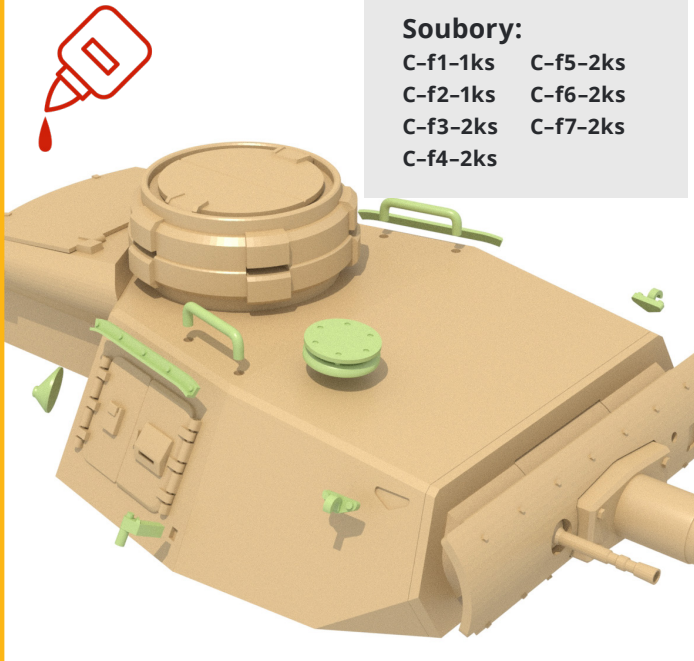

D

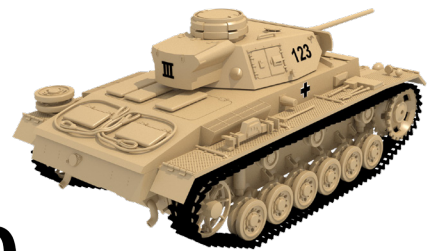

Soubory:

- D-1
- D-2
- D-3
- D-4
- D-5
- D-6
- D-7
- D-8
- D-9
- D-10
- D-11
- D-12
- D-13

✚ III 1234567890

E

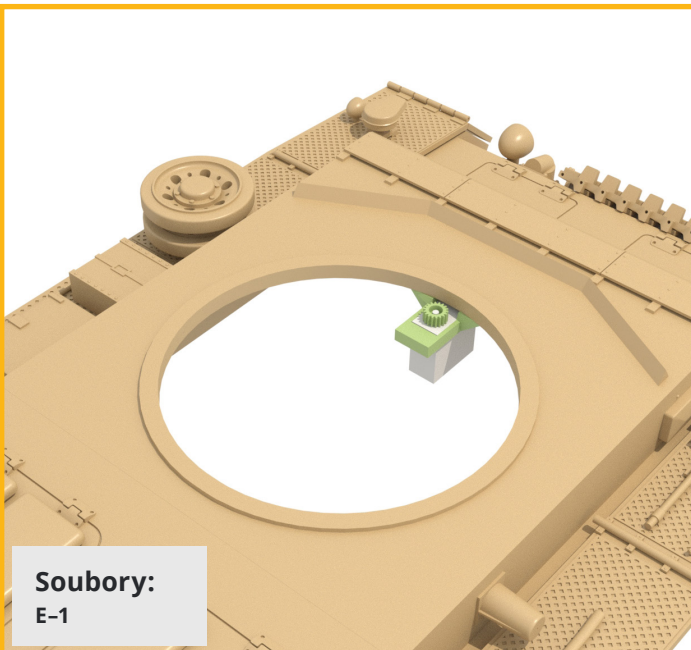

Soubory:
E-1



Soubory:
E-2







autor: *Petr Školař*
web: www.3dtiks.store
e-mail: 3dtisk@gpstudio.cz