

VERZE 1.2.

2024



Panzerkampfwagen III Panzer III PzKpfw III

1:10



UPDATE - V-1.2.



NÁVOD KE STAVBĚ

www.3dtisk.store

Stavební manuál

3d tisk

Nastavení :

Nastavení tisku: **0.20mm** (u spojovacích dílů **0.15mm** přesnější např. vkládání kuličkových ložisek)

Výplň: **15%** (u pohyblivých částí **100%** např. převodovky)

Filament: **PLA 3 Kg**
Souborů STL: **253 ks**
Délka tisku: **9 dní**

UPDATE V-1.2.

kombinovaná převodovka, sylnější hnací osa, jednodušší sestavení, vyměnitelné díly, nové napínání pásů

Spojovací materiál

Šrouby

M3 x 16mm = 66ks

M3 x 10mm = 8ks

Ložiska:

Kuličkové ložisko 10 x 15 x 4mm = 20ks

Kuličkové ložisko 12 x 21 x 5mm = 4ks

70XL rozvodový pás

šířka: 6,35 mm, zubů: 35 = 4ks

Pružiny:

0,5 mm, 30 mm, 5 mm = 12ks

Drát vázací: tl. 1 mm

Sekundové lepodlo

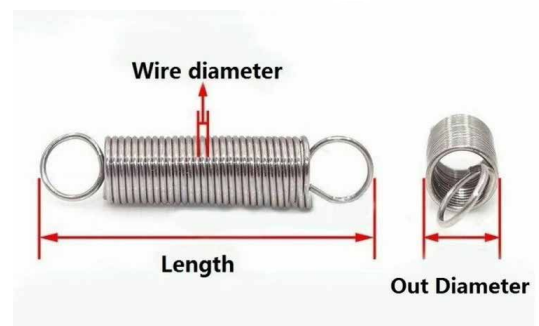

Motory:

Stejnoseměrné motory 540

Rozměry (Ø x d) 35.8 mm x 50 mm

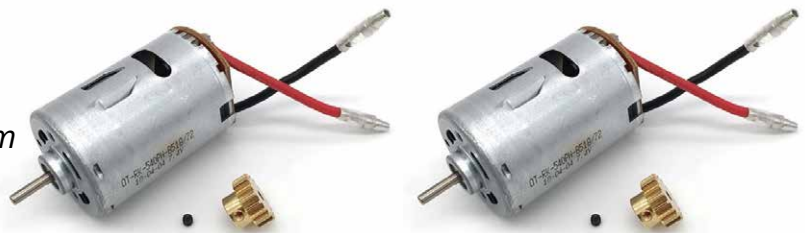

Regulátory:

obousměrný elektrický regulátor rychlosti, pro
stejnoseměrné motory.



Serva:

20,3x38x40,5mm



SCHEMA ZAPOJENÍ

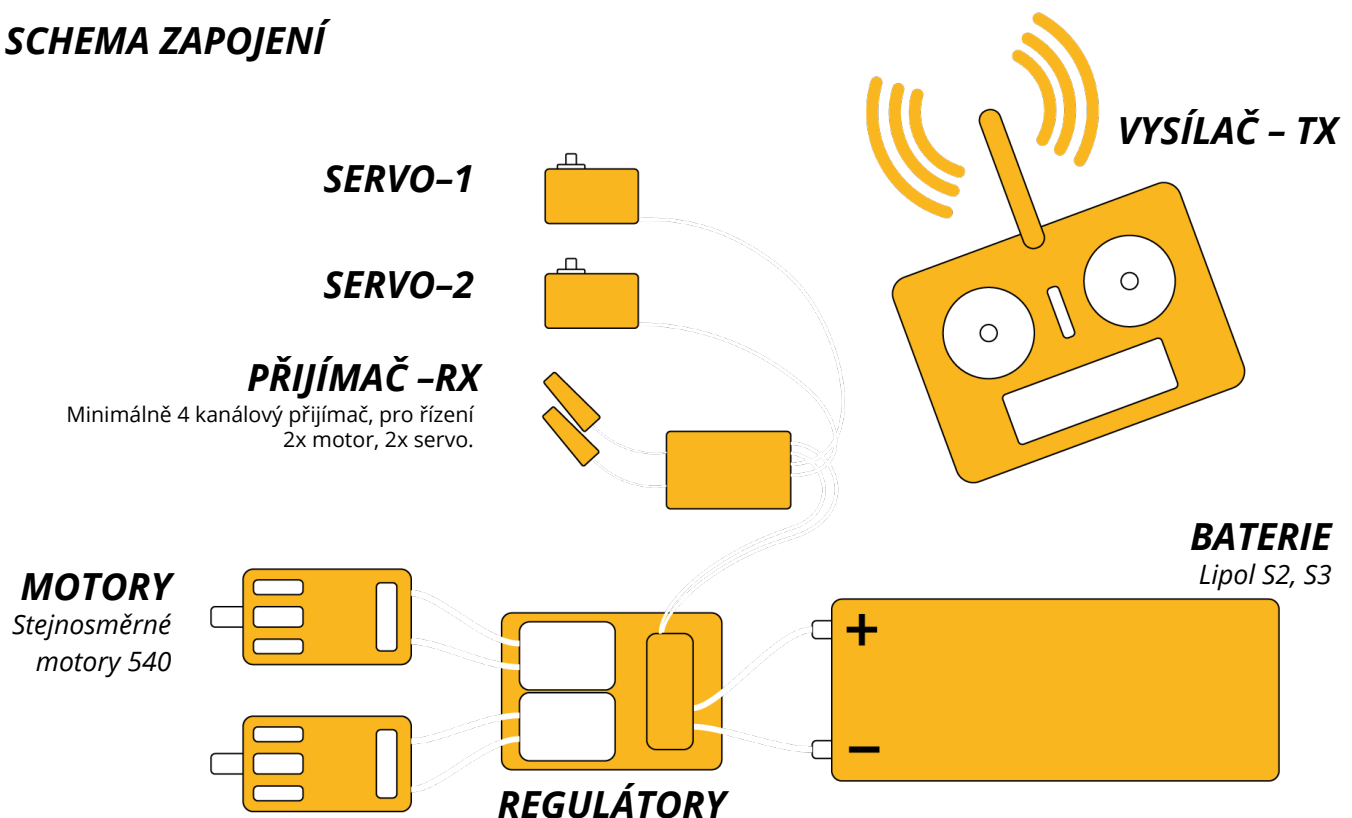

Panzer III

PARAMETRY MODELU

Měřítko: 1:10

Rozměr: 657 x 345 x 279 mm

Váha: 4,5 Kg



A

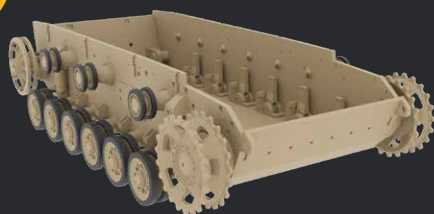

E



B



F

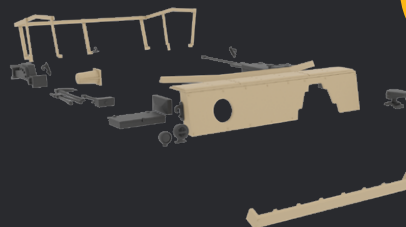

C



G

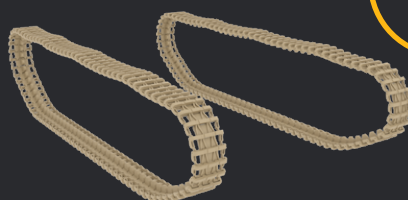

D

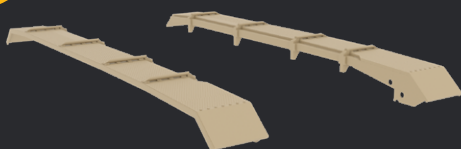

P



Panzer III

A

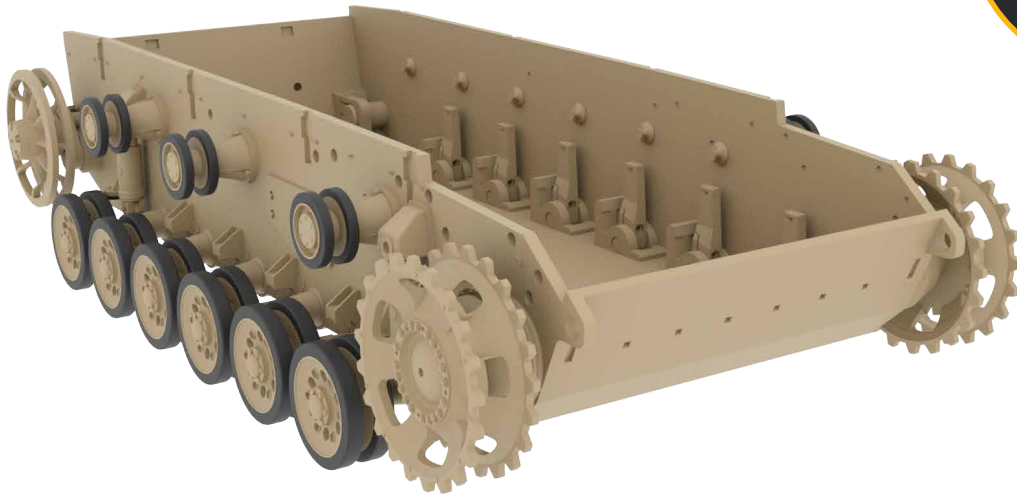

Soubory:

- A-1-1x
- A-2-1x
- A-3-1x

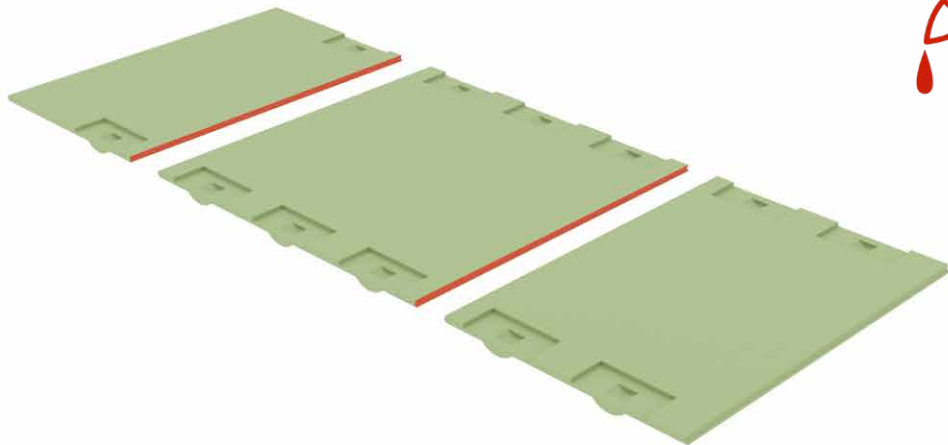

Soubory:

- A-4-right-6x
- A-4-left-6x
- A-5-right-6x
- A-5-left-6x

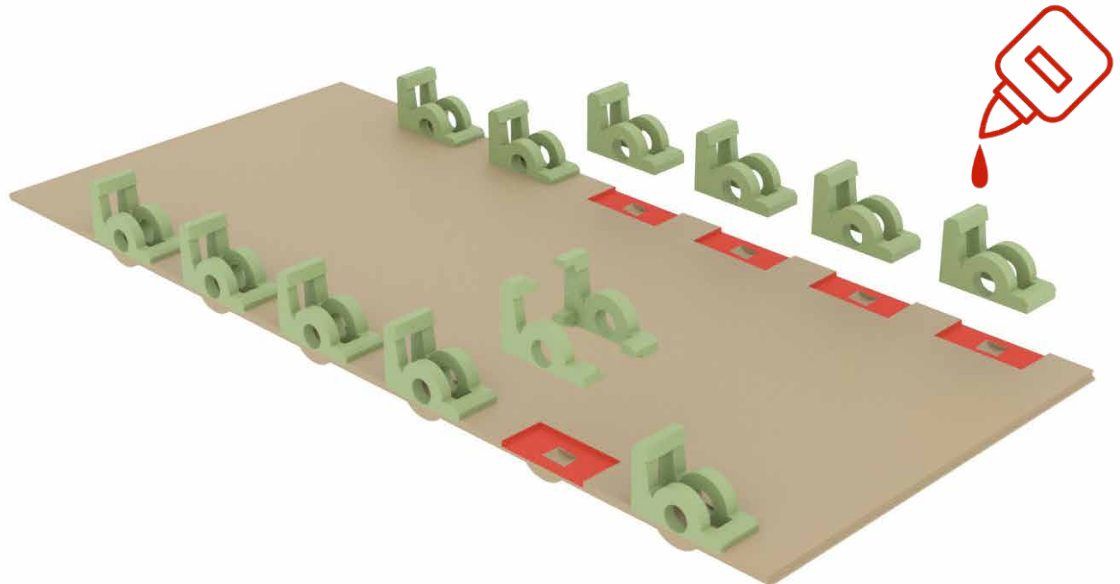

Soubory:

- A-6-right-1x
- A-6-left-1x
- A-7-right-1x
- A-7-left-1x
- A-8-right-1x
- A-8-left-1x

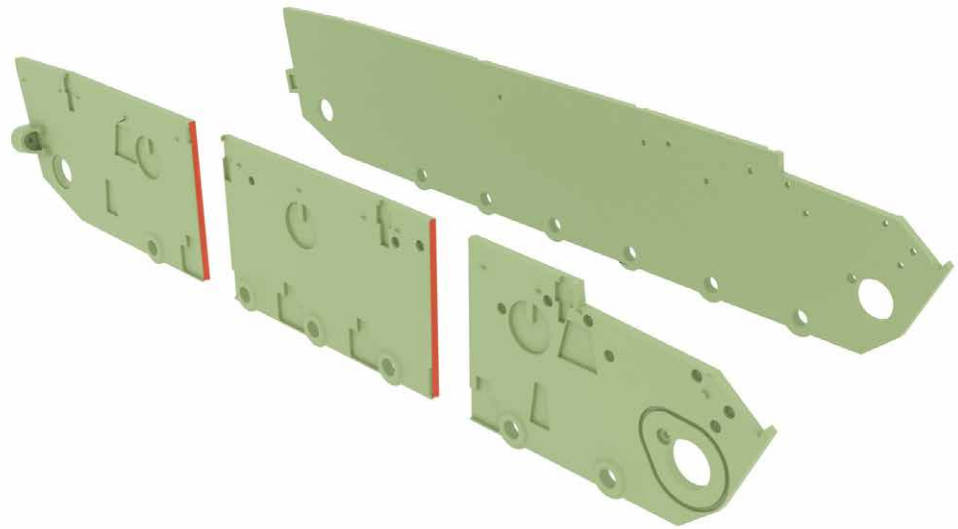

Soubory:

- A-11-1x
- A-12-left-1x
- A-12-right-1x

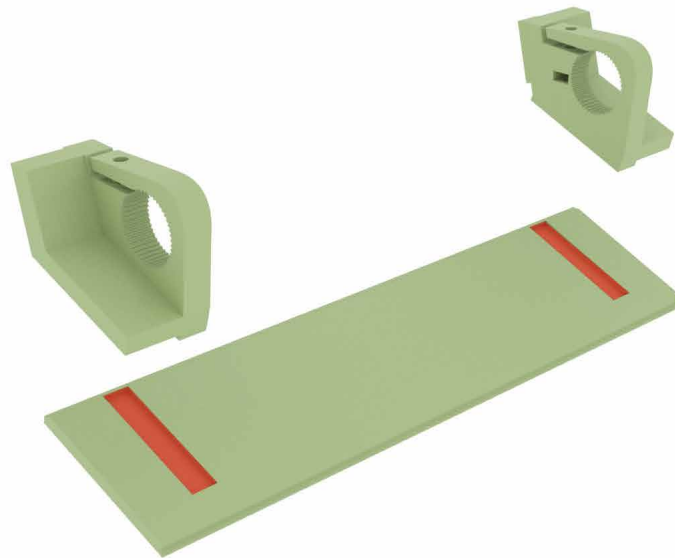

Soubory:

- A-9-1x
- A-10-1x
- A-11-1x
- A-12-left-1x
- A-12-right-1x
- A-13-1x

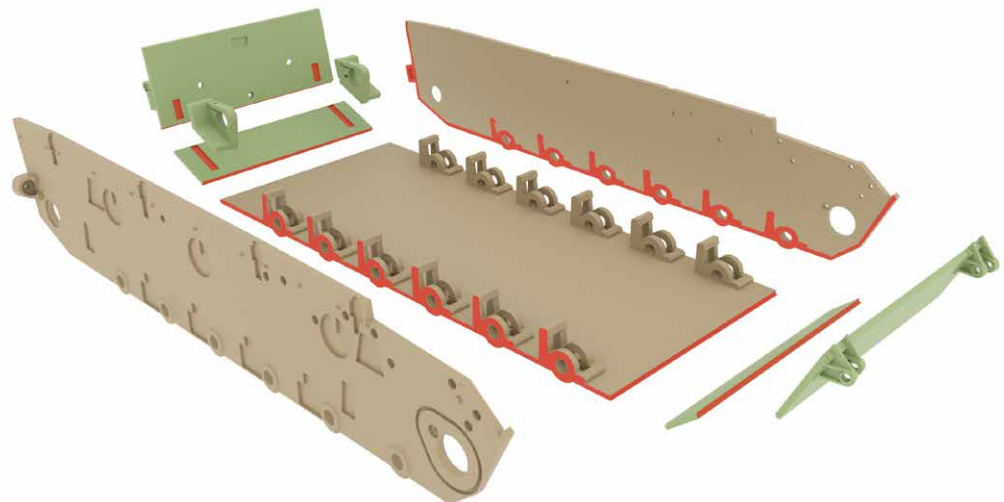

Soubory:

A-14-4x

A-15-FLEX-4x

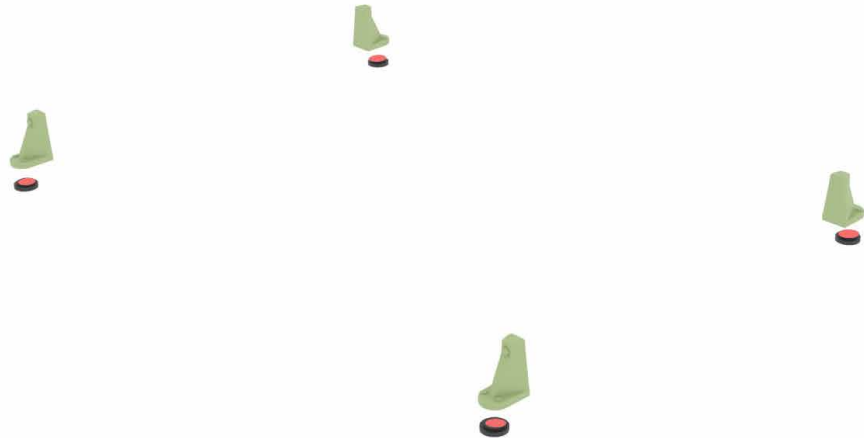
**Soubory:**

A-14-4x

A-15-FLEX-4x

A-16-8x

A-17-6x

A-18-4x

A-19-1-right-1x

A-19-1-left-1x

A-20-2x

M3 16mm 2x

Ložisko-

12x21x5mm-2x

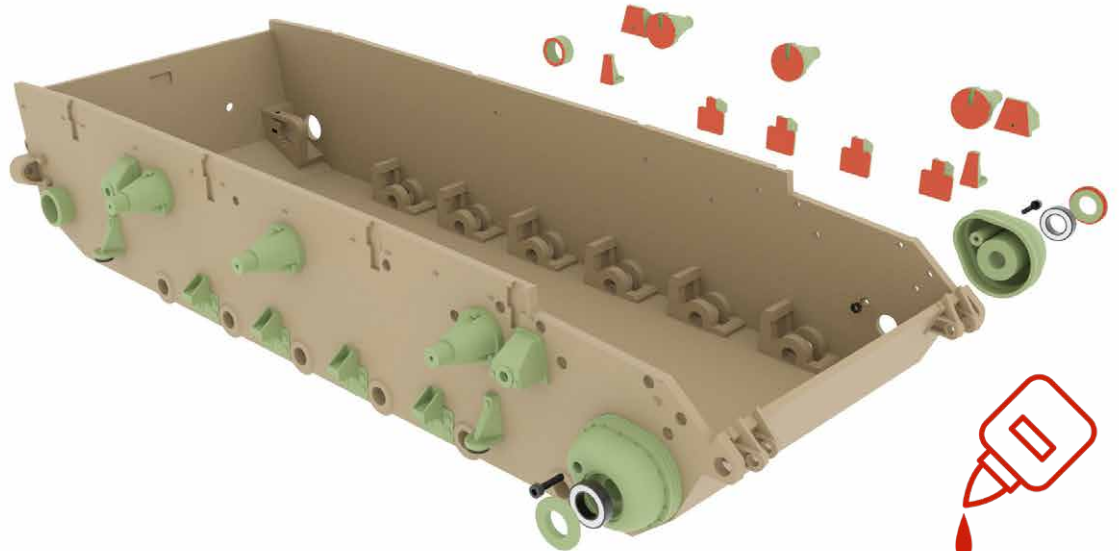
**Soubory:**

A-21-6x

A-22-6x

A-23-12x

A-24-FLEX-12x

M3 16mm 6x

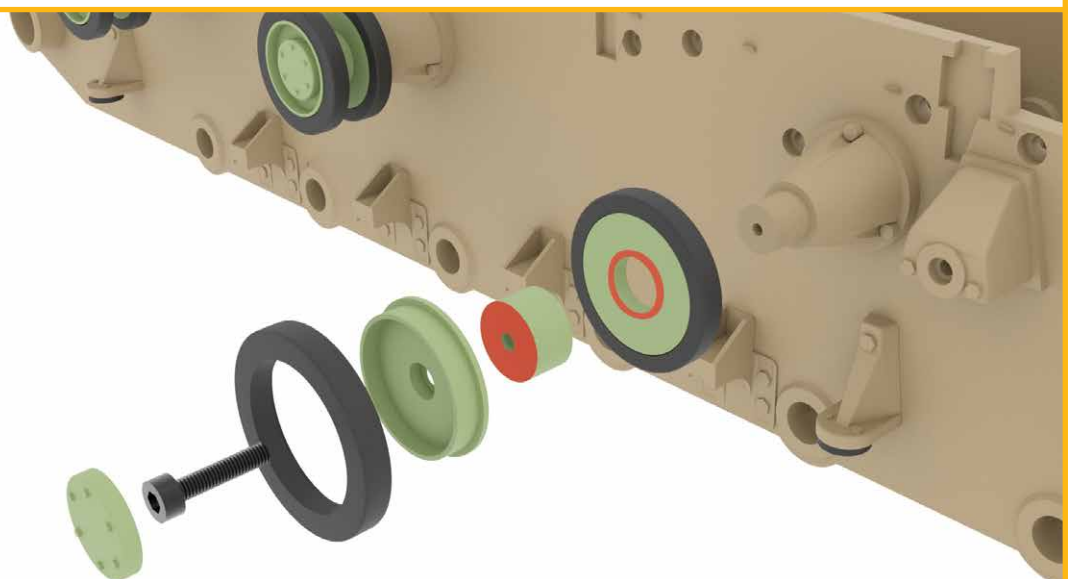

A

Soubory:

A-25-12x
A-26-12x
A-27-12x
A-28-12x
A-29-FLEX-12x

Ložiska
10x15x4 mm

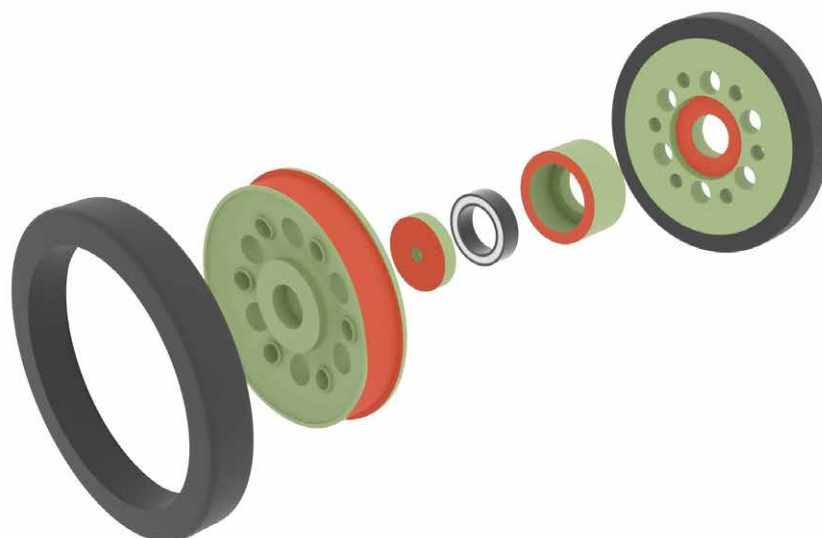

Soubory:

(A-25-12x, A-26-12x, A-27-12x, A-28-12x, A-29-FLEX-12x)
A-30-12x
A-31-right-2x
A-31-left-2x
A-32-right-4x
A-32-left-4x
A-32-12x



Soubory:

A-33-4x
A-34-4x



Soubory:
A-35-right-6x
A-35-left-6x

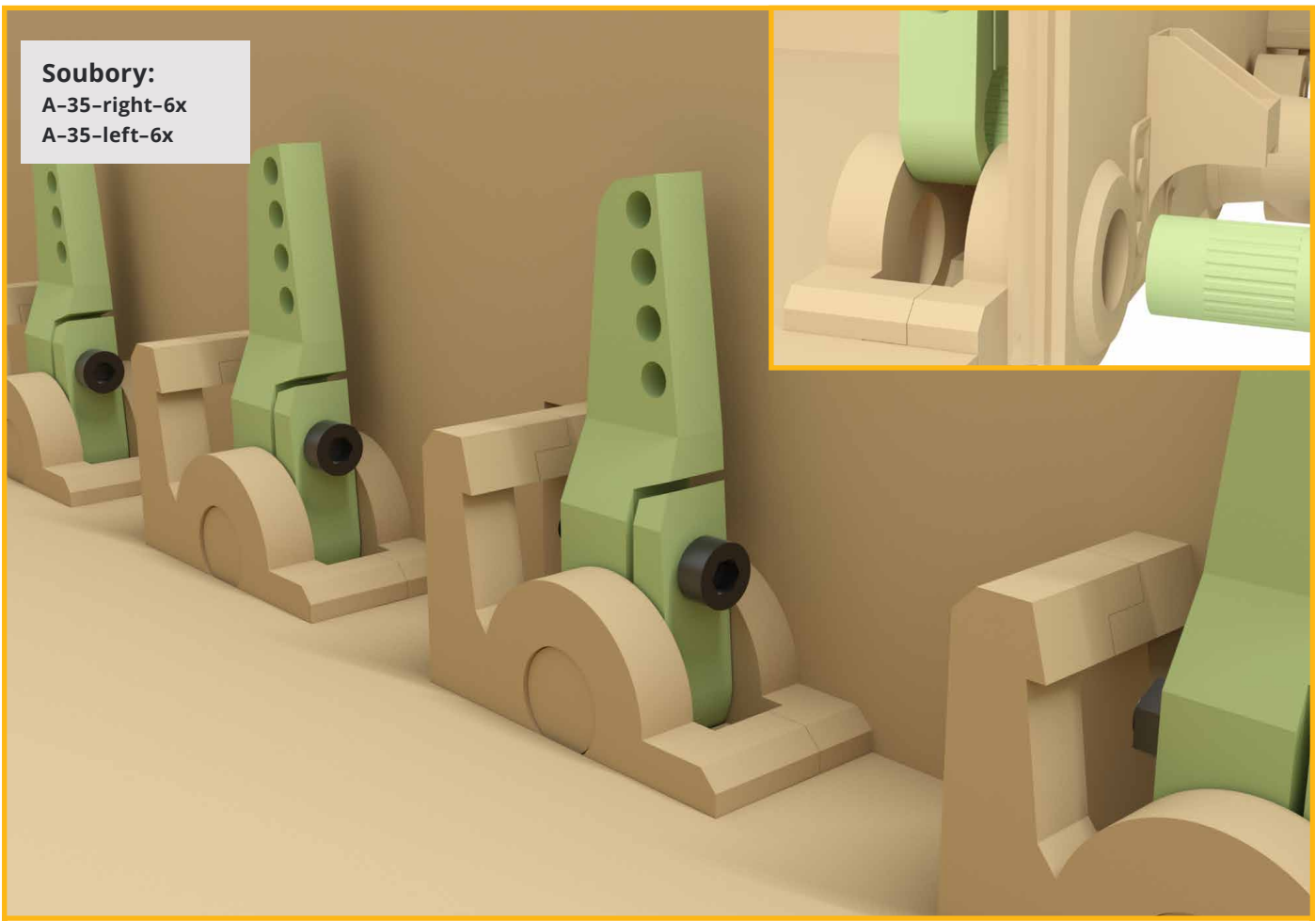

Soubory:
A-36-12x

Pružiny



Soubory:

A-37-2x
 A-38-2x
 A-39-2x
 A-40-2x
 A-41-2x
 A-42-2x

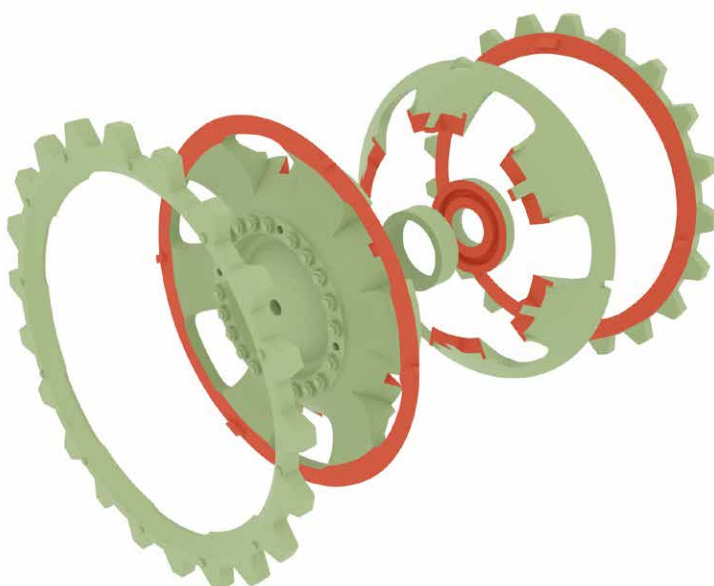
**Soubory:**

A-43-2x
 A-44-4x
 A-45-2x
 A-46-2x
 A-47-6x

Ložiska
 10x15x4 mm

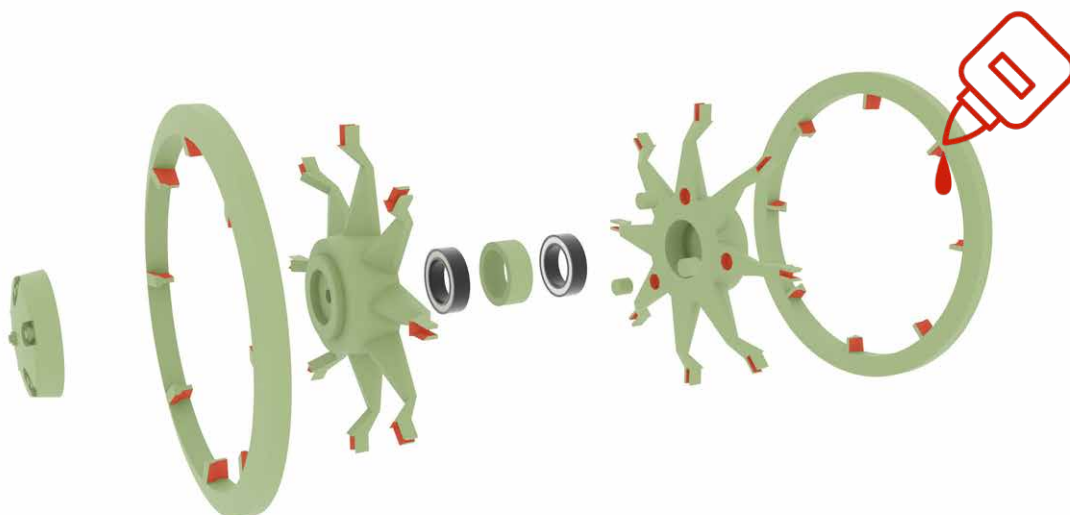
**Soubory:**

A-49-2x
 A-50-left-1x
 A-50-right-1x
 A-51-2x
 A-52-2x

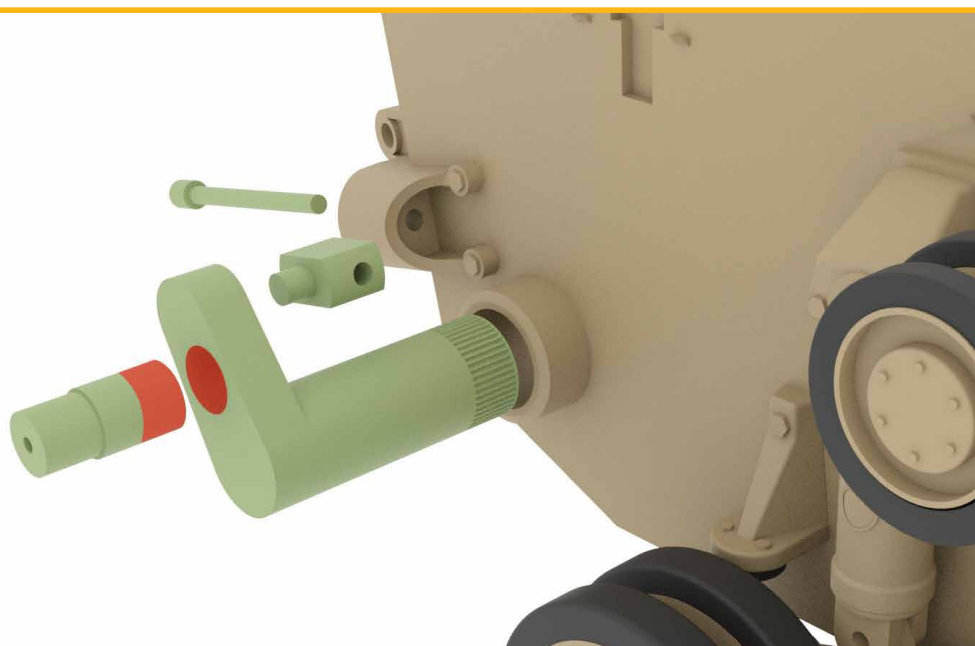

Soubory:
A-48-2x

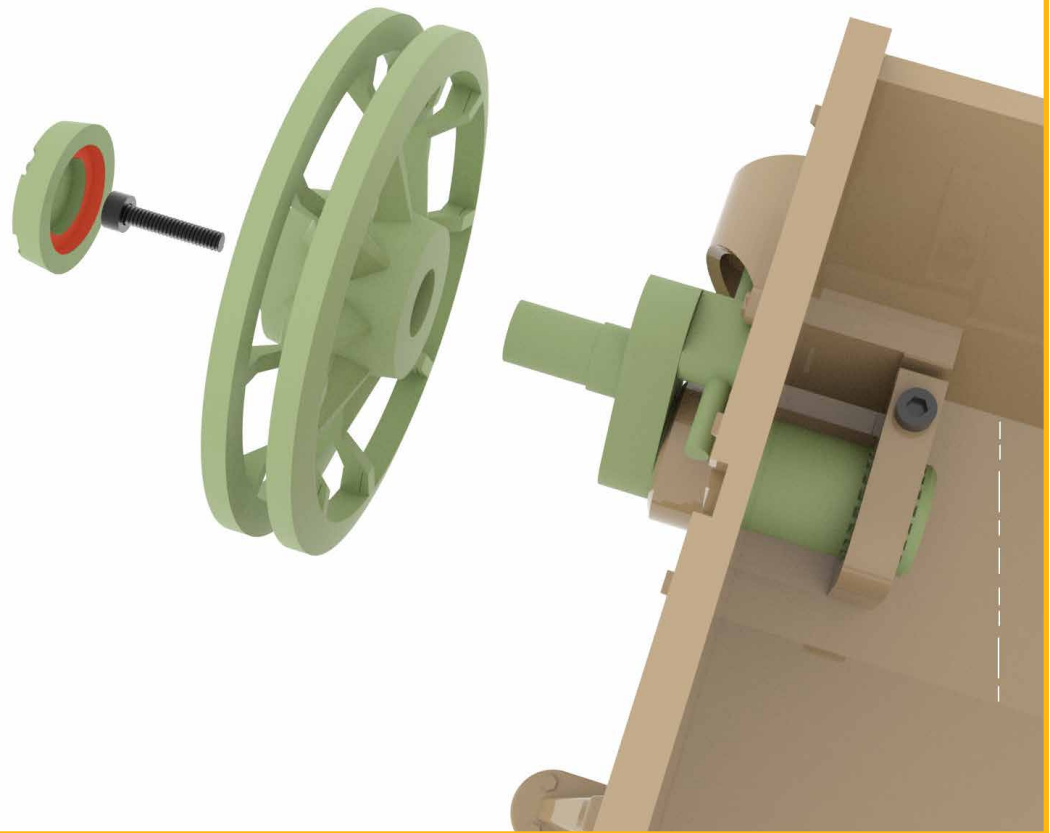

Soubory:
A-53-left-1x
A-53-right-1x
A-54-left-1x
A-54-right-1x
A-55-1x
A-56-1x
A-57-1x

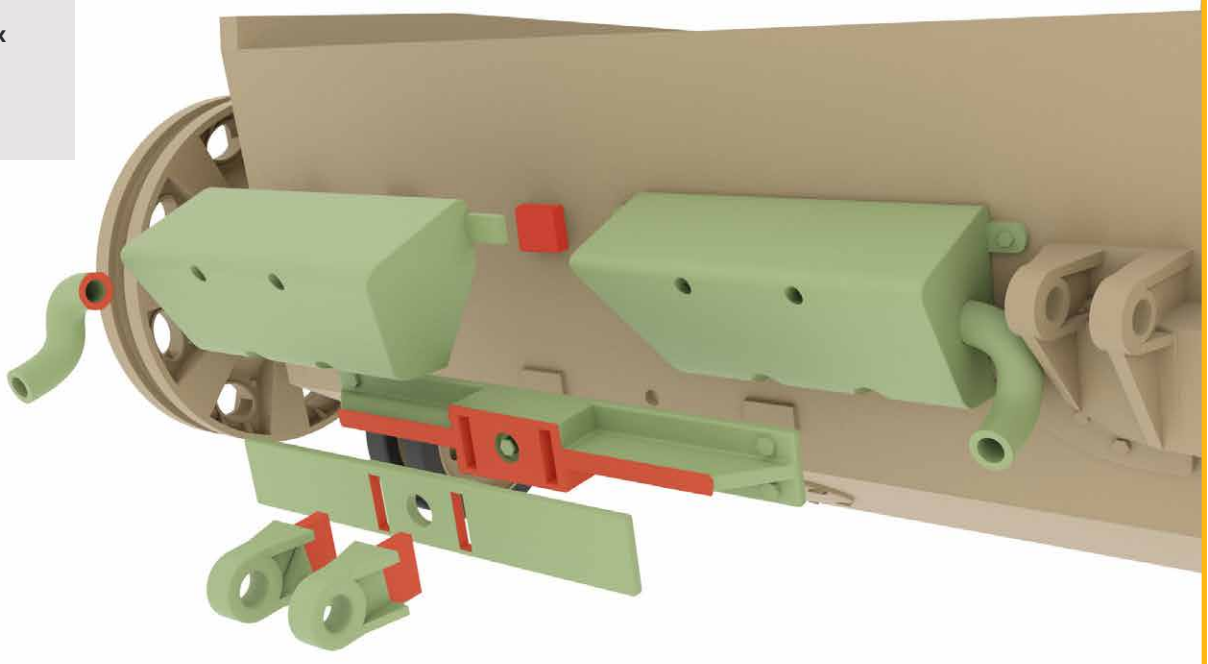

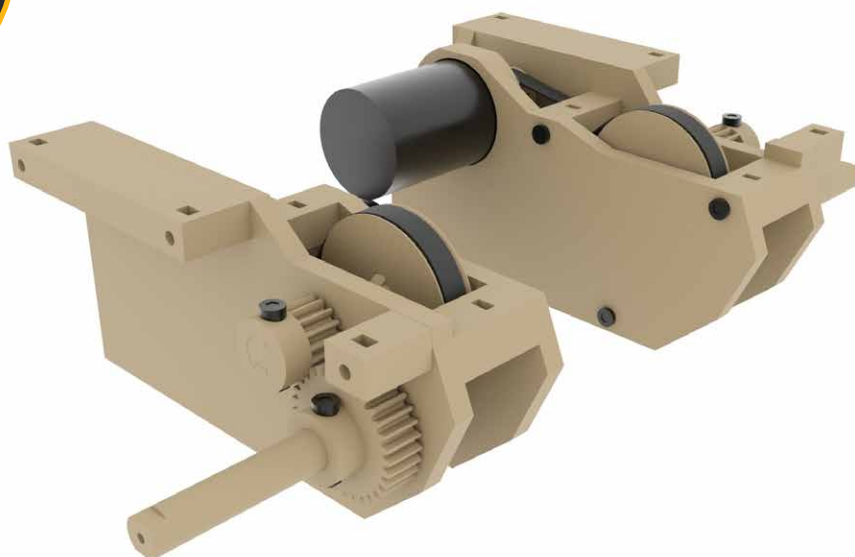

Soubory:

- P-1-right-1x
- P-1-left-1x
- P-2-right-1x
- P-2-left-1x
- P-3-right-1x
- P-3-left-1x

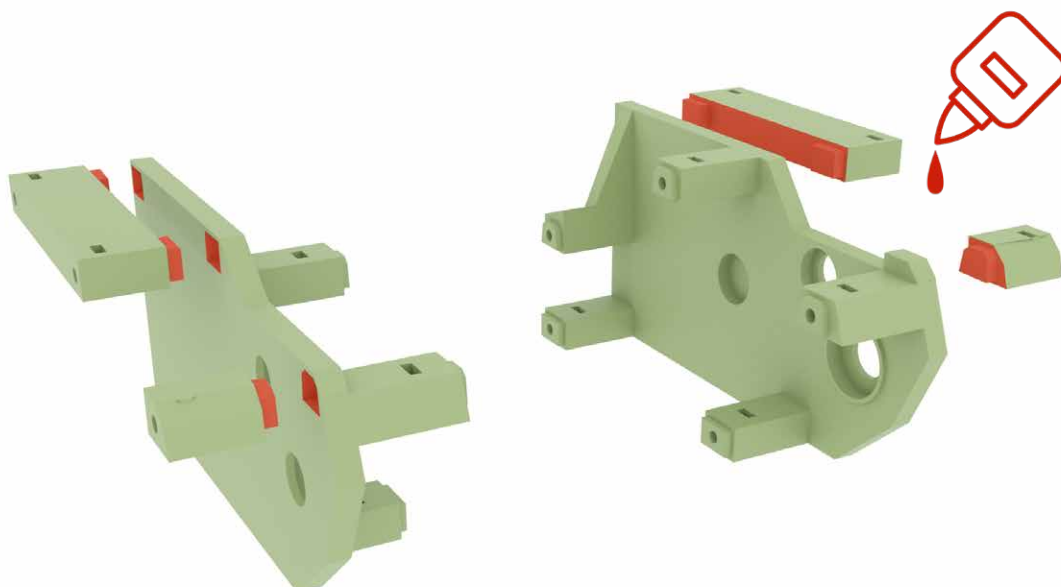

Soubory:

- P-4-2x
- P-5-2x
- M3 16mm 2x
- Ložisko-
12x21x5mm-2x

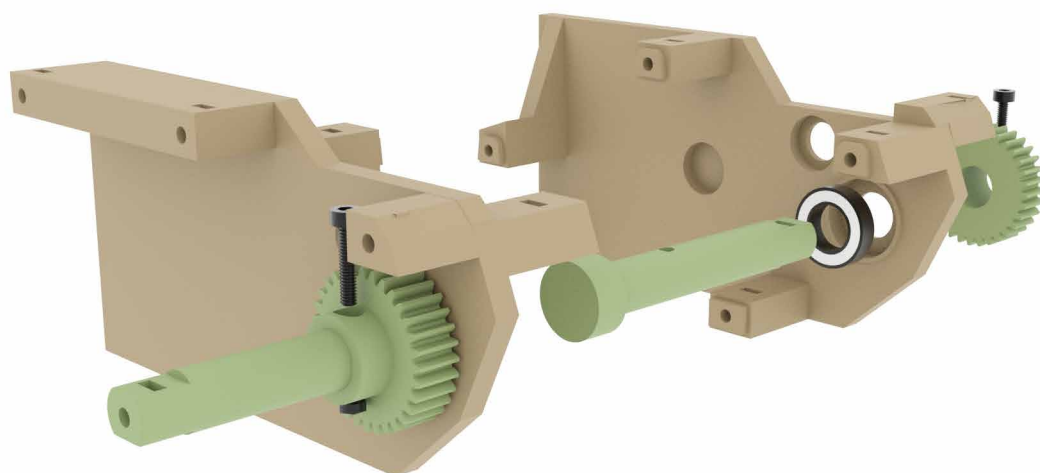

Files:

- P-6-2x
- P-7-2x
- P-8-2x
- P-9-2x
- P-10-2x

- Bearings-
10x15x4mm-4x
- M3 16mm 2x

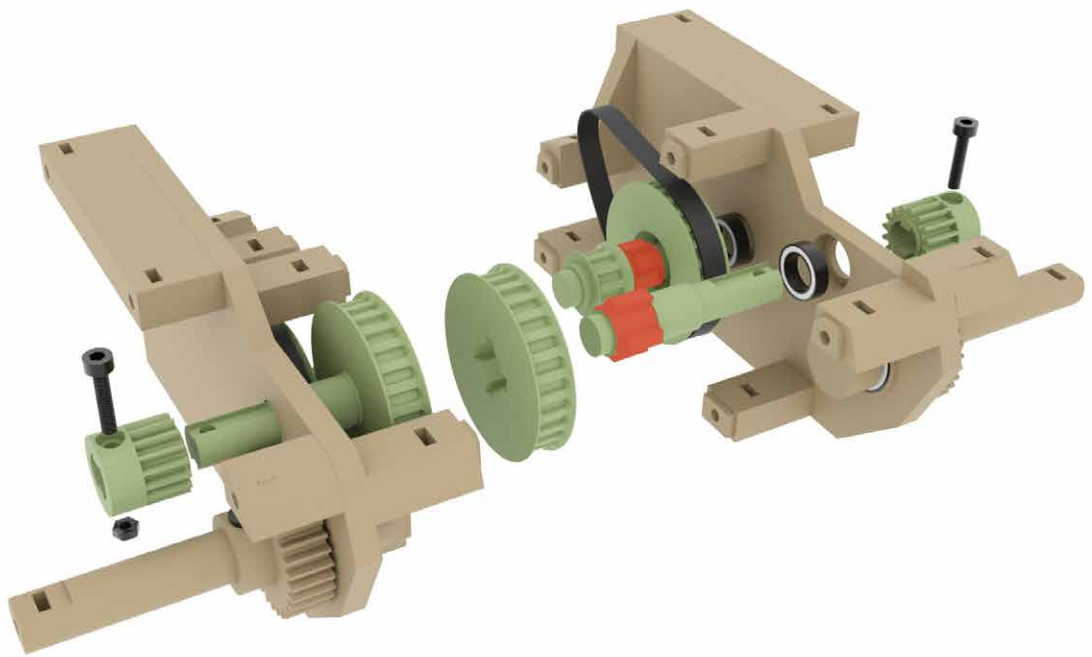

Files:

- P-11-2x
- P-12-right-1x
- P-12-left-1x

- M3 16mm 2x
- Bearings
10x15x4mm-4x



Files:
M3 16mm 12x

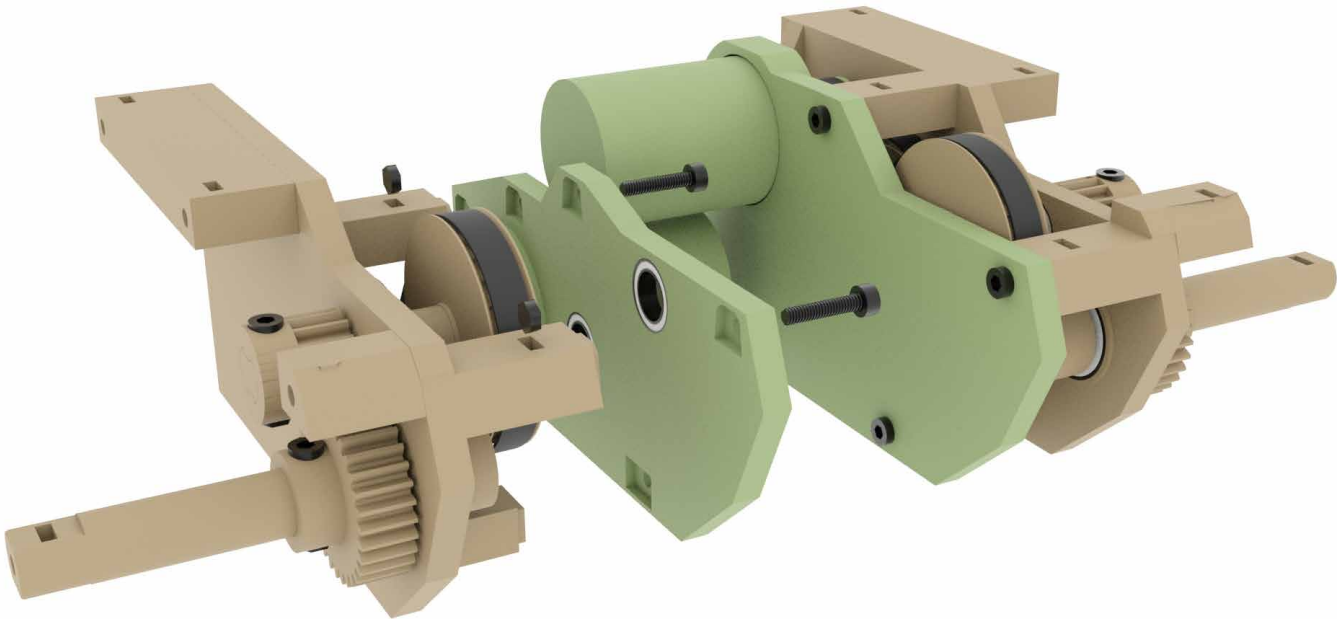



Soubory:

- B-1-1x
- B-3-1-right-3x
- B-3-1-left-3x



Soubory:

- B-2-1x
- B-3-1-right-3x
- B-3-1-left-3x
- B-4-right-1x
- B-4-left-1x

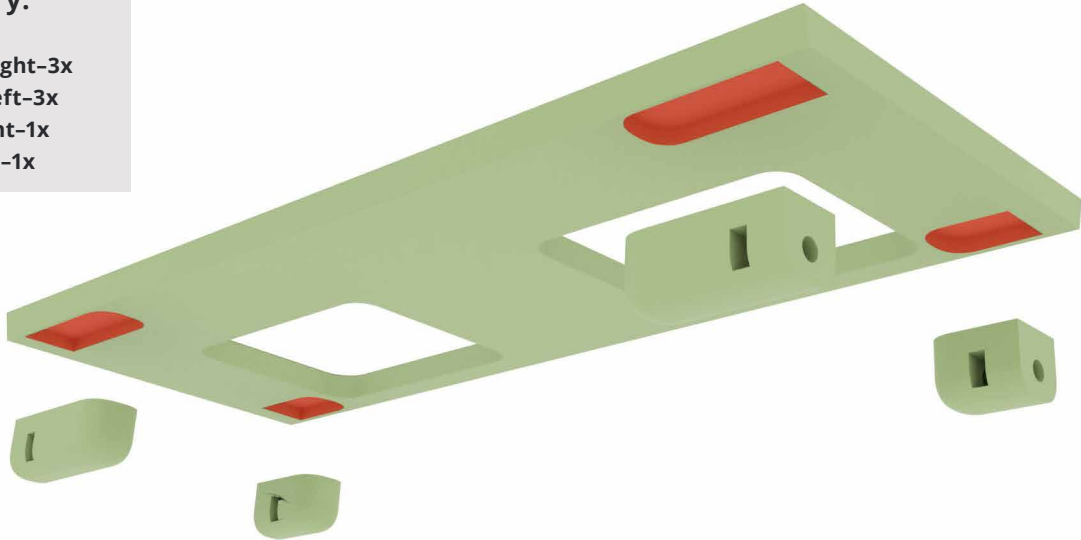

B

Soubory:

- B-5-2x
- B-6-2x
- B-7-2x
- B-8-2x
- B-9-1x

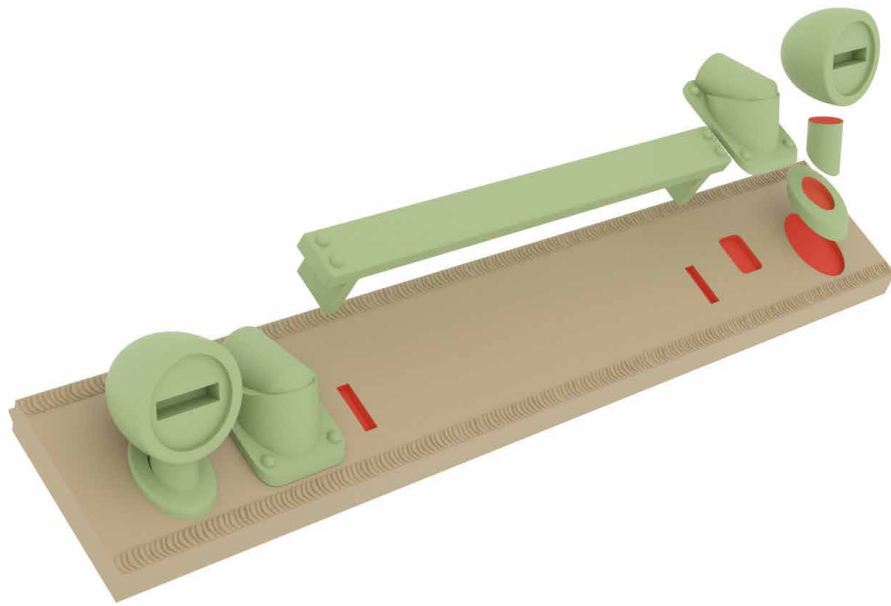

Soubory:

- B-10-4x
- B-11-4x
- B-12-2x
- B-13-1x

Wire 1mm

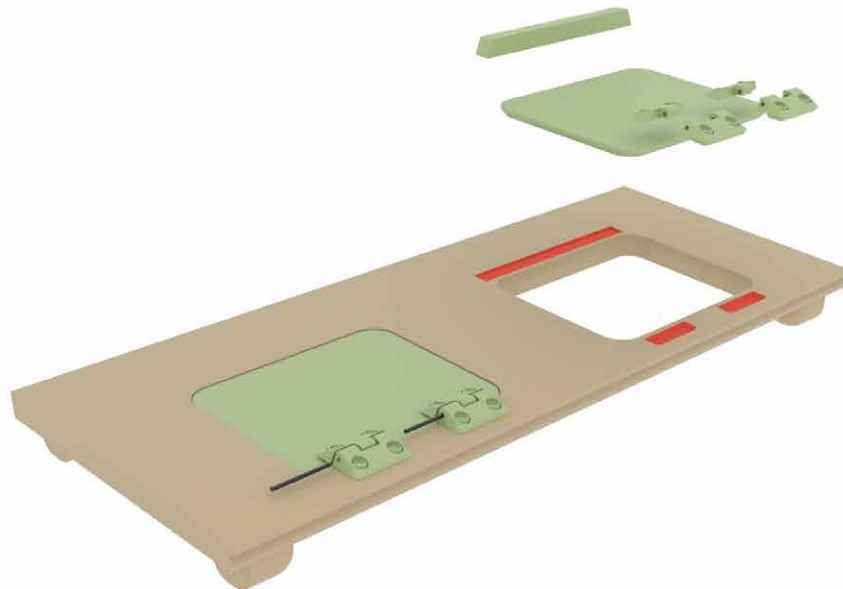

Soubory:

- B-14-1x
- B-15-1x
- B-3-1-right-3x
- B-3-1-left-3x
- B-3-2-right-2x
- B-3-2-left-2x

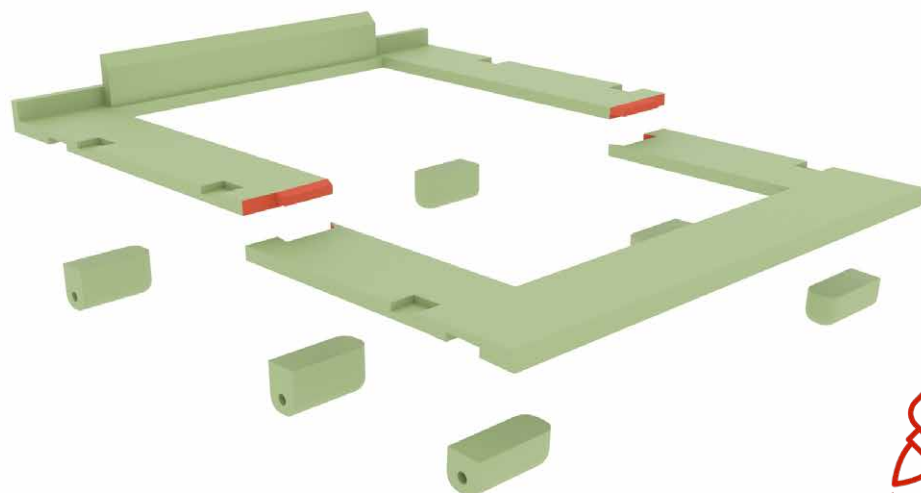

Soubory:

- B-16-1x
- B-17-1x
- B-18-1x
- B-19-1x
- B-20-1x
- B-21-1x

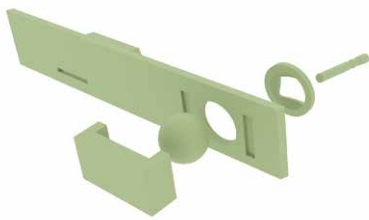

Soubory:

- B-22-right-1x
- B-22-left-1x
- B-23-right-1x
- B-23-left-1x
- B-24-6x

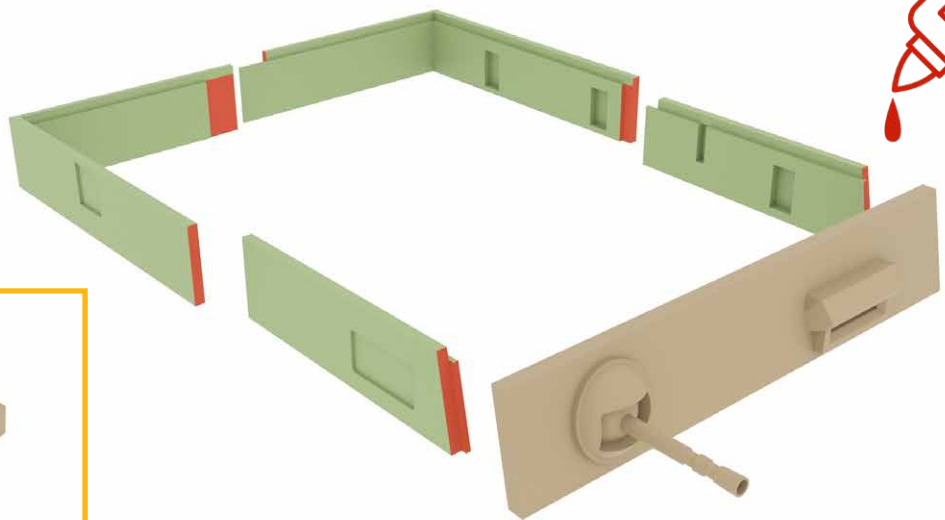

Soubory:

- B-25-2x
- B-26-1x
- B-27-1x
- B-28-2x

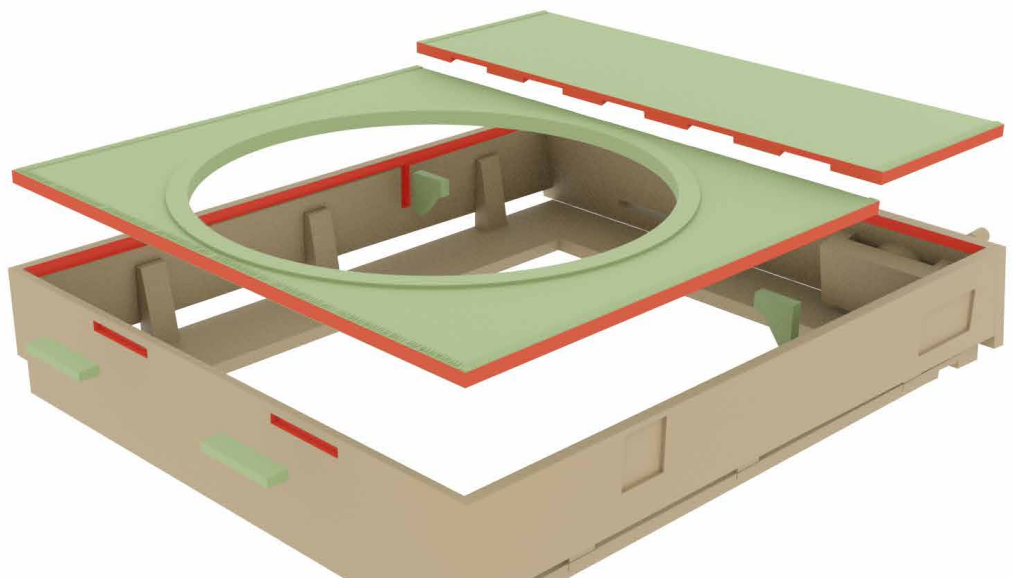



Soubory:
C-1-1x
C-2-1x

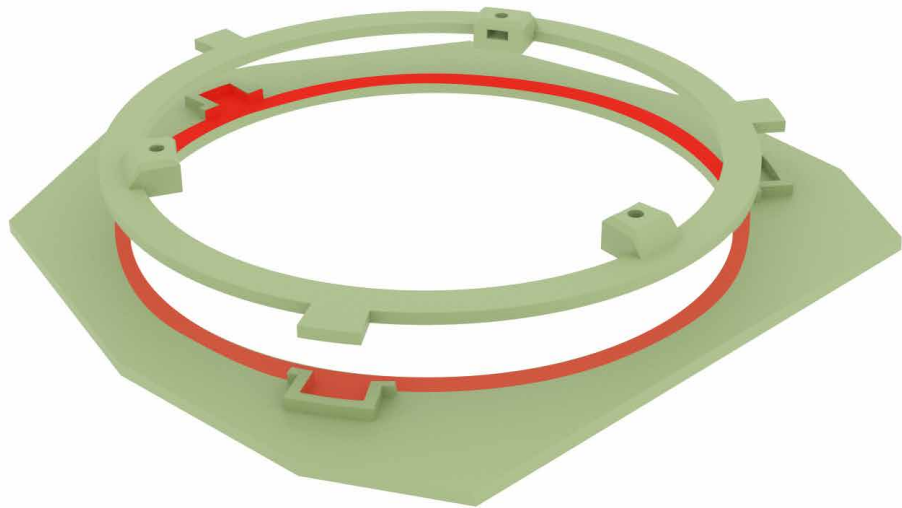

Soubory:
C-3-1x

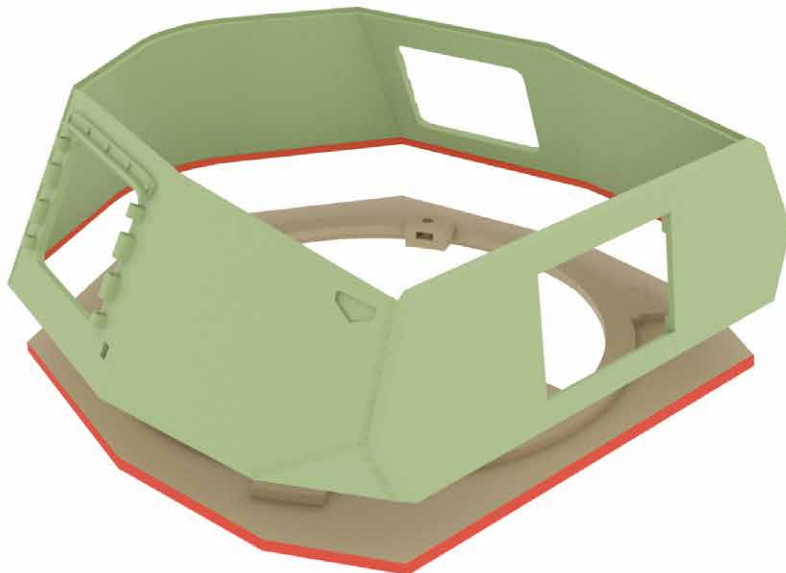

Soubory:

- C-4-1-1x
- C-4-2-1x
- C-5-1x
- C-6-right-1x
- C-6-left-1x
- C-7-right-1x
- C-7-left-1x

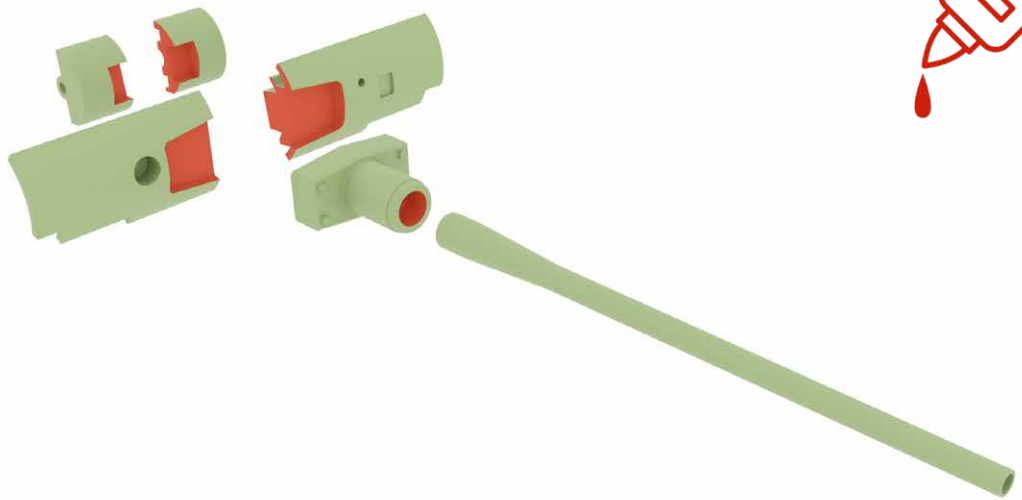

Soubory:

- C-8-right-1x
- C-8-left-1x
- C-9-1x

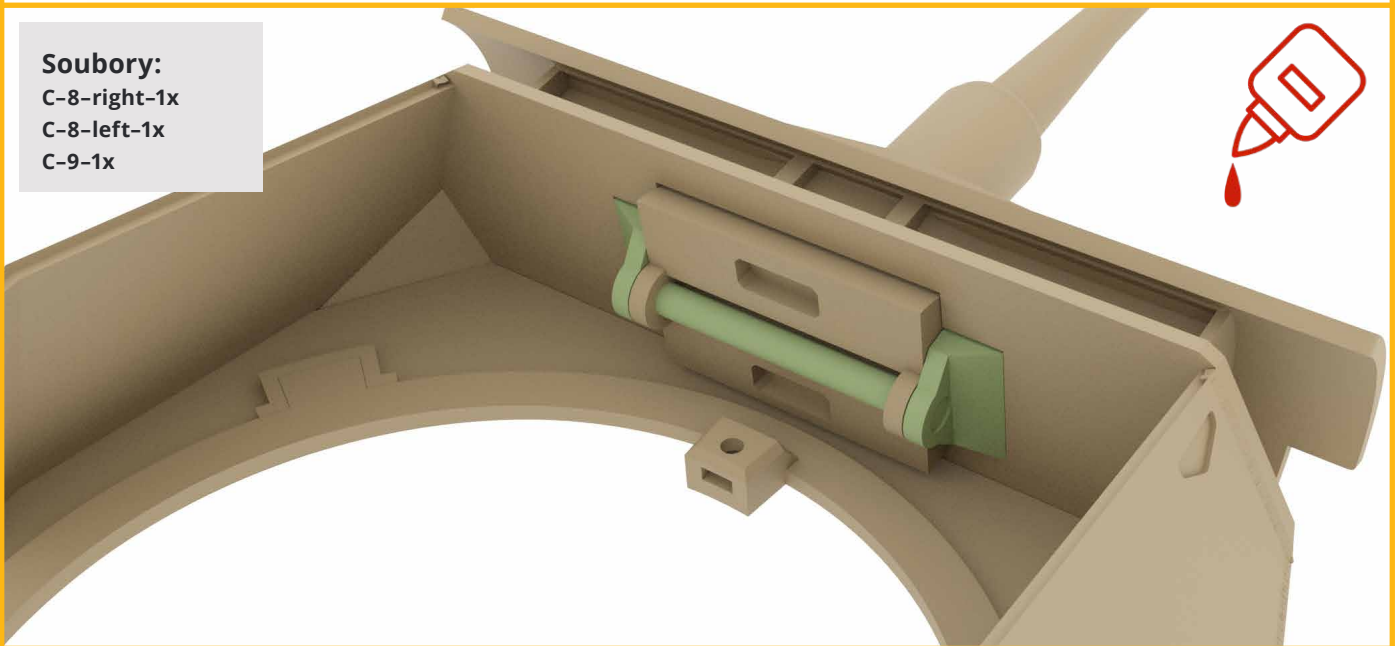

Soubory:

- C-10-1x





Soubory:

C-11-1x

C-12-1x

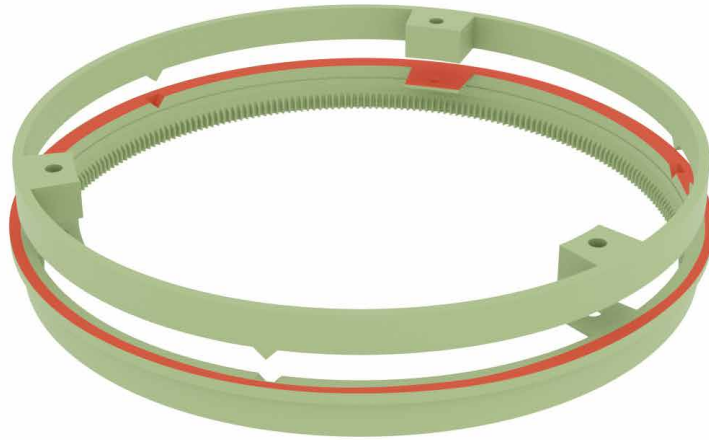

Soubory:

B-23-2x

B-24-1x

B-25-1x

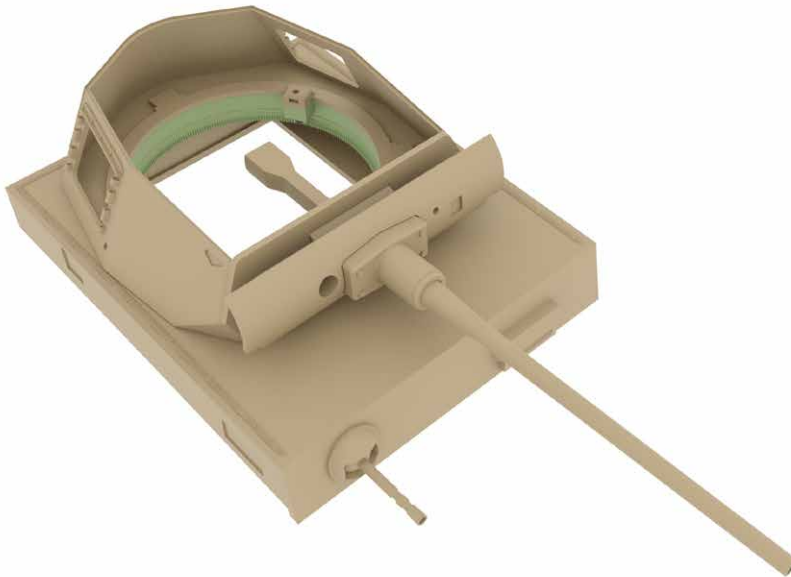

Soubory:

- C-13-1x
- C-14-1x
- C-15-1x
- C-16-1x
- C-17-1x
- C-18-1x
- C-19-1x

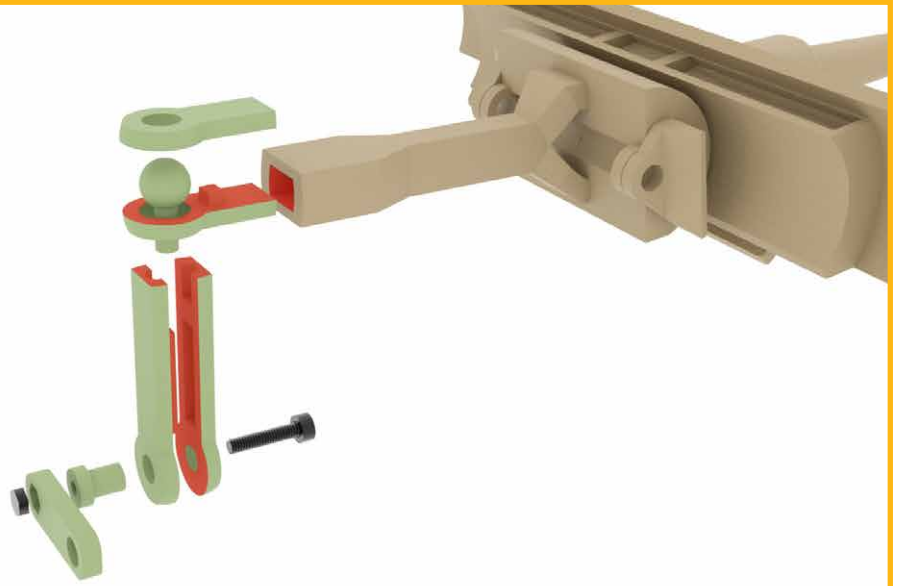

Soubory:

- C-20-1x
- C-21-1x
- C-22-1x

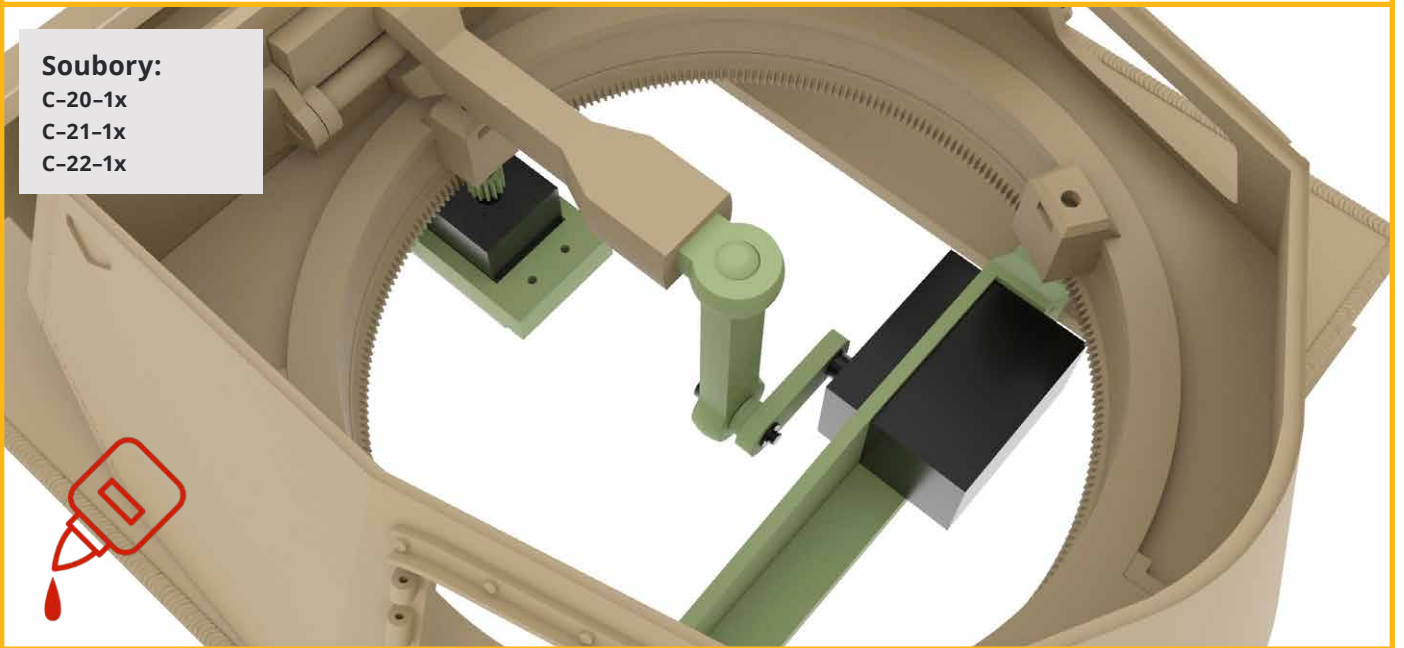

Soubory:

- C-23-1x
- C-24-1x

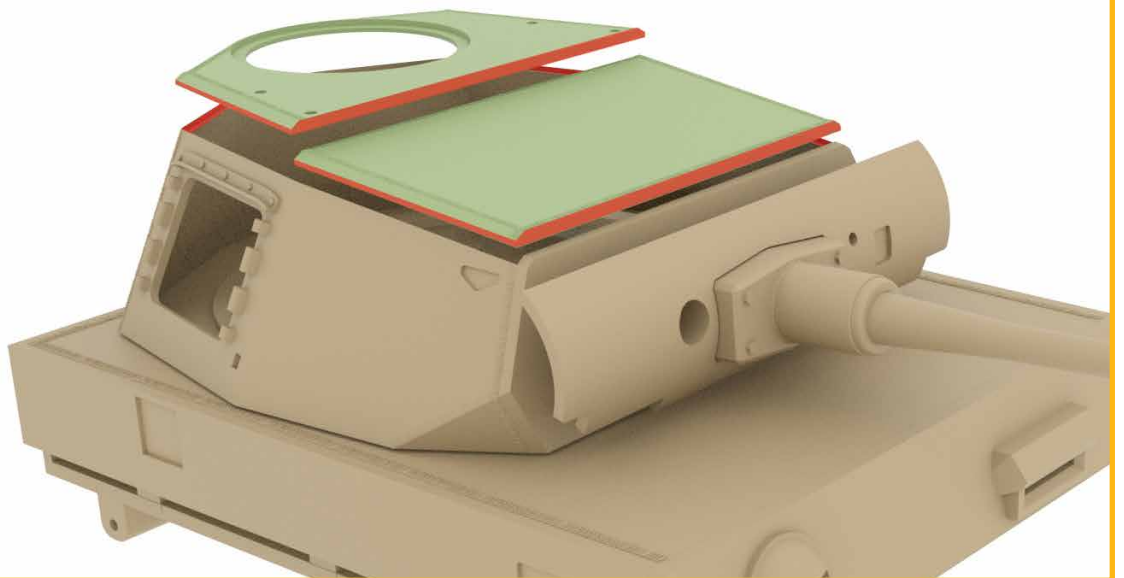

Soubory:

- C-25-1x
- C-26-1x
- C-27-3x

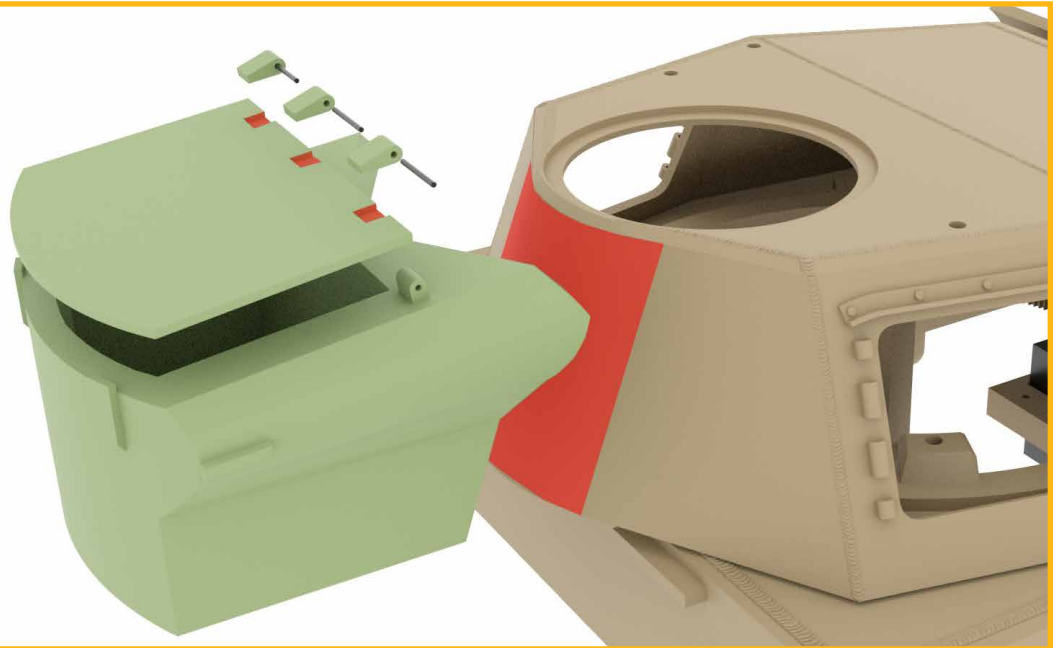

Soubory:

- C-28-2ks
- C-29-2ks
- C-30-2ks
- C-31-2ks
- C-32-1ks
- C-33-1ks
- C-34-right-1ks
- C-34-left-1ks
- C-35-right-1ks
- C-35-left-1ks

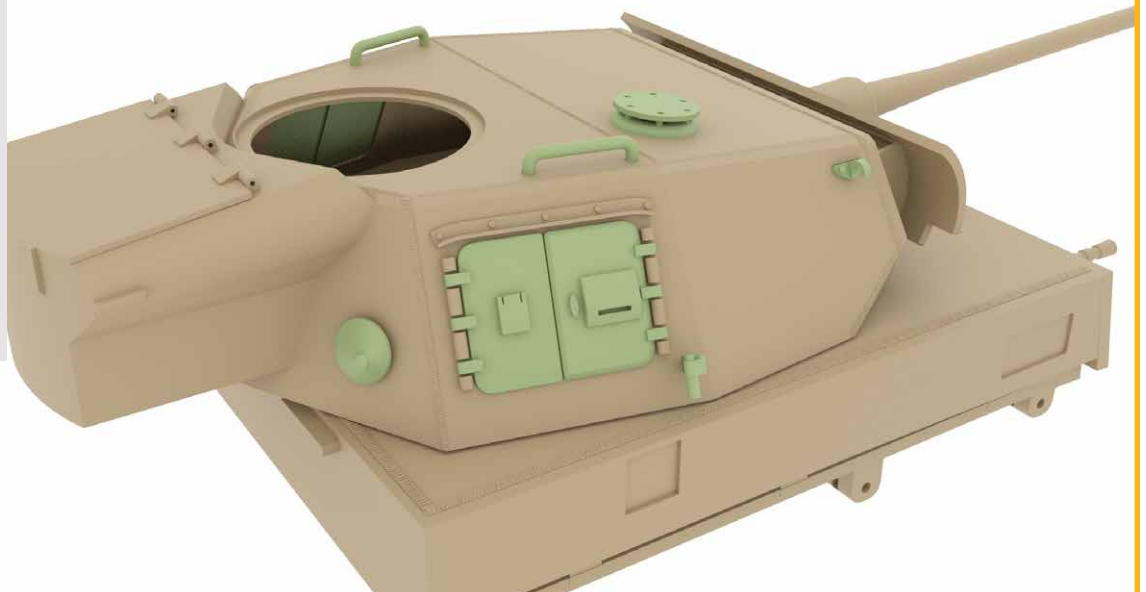

Soubory:

- C-36-1x
- C-37-1x
- C-38-1x
- C-39-1x
- C-40-2x
- C-41-1x



Soubory:

D-1-right-1x
 D-1-left-1x
 D-2-right-1x
 D-2-left-1x
 D-3-right-1x
 D-3-left-1x
 D-4-right-1x
 D-4-left-1x

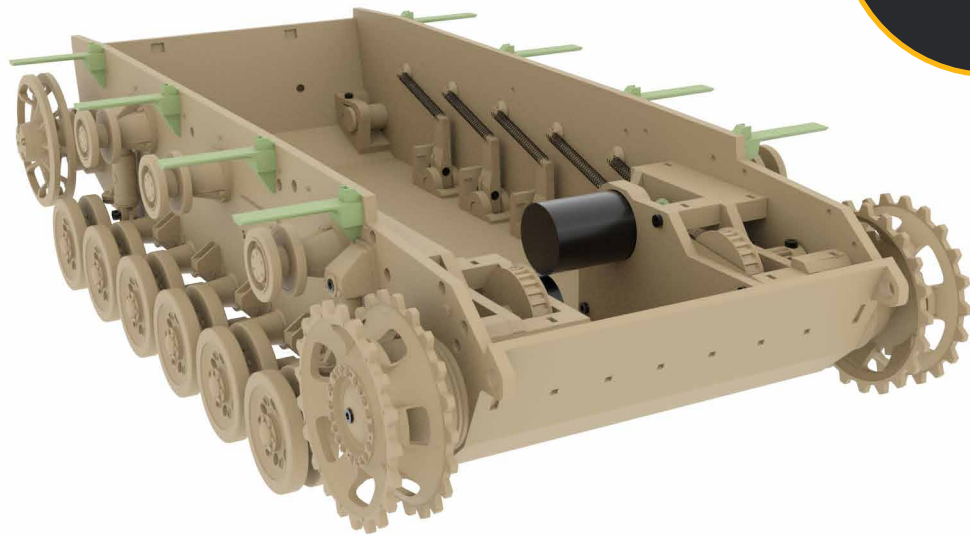
**Soubory:**

D-5-right-1x
 D-5-left-1x
 D-6-right-1x
 D-6-left-1x
 D-7-right-1x
 D-7-left-1x
 D-8-right-1x
 D-8-left-1x
 D-9-right-1x
 D-9-left-1x

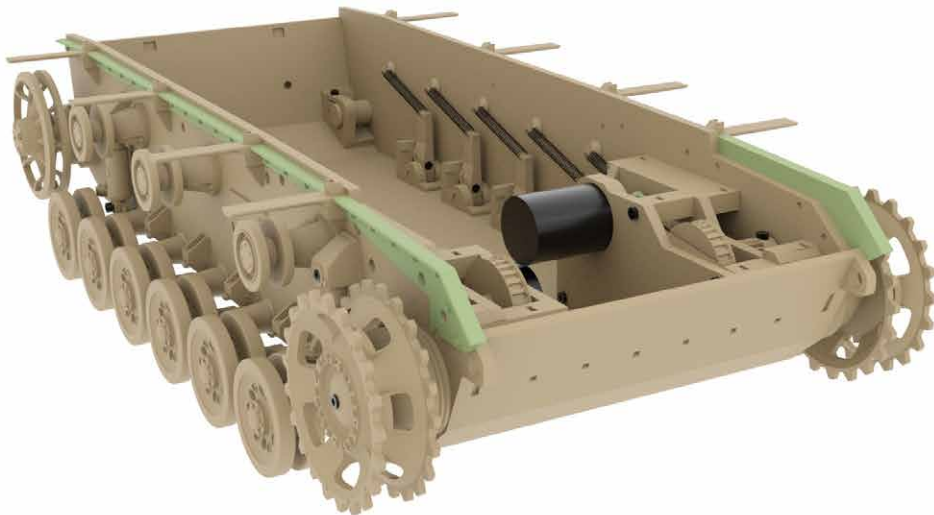
**Soubory:**

D-10-right-1x
 D-10-left-1x
 D-11-right-1x
 D-11-left-1x
 D-12-right-1x
 D-12-left-1x

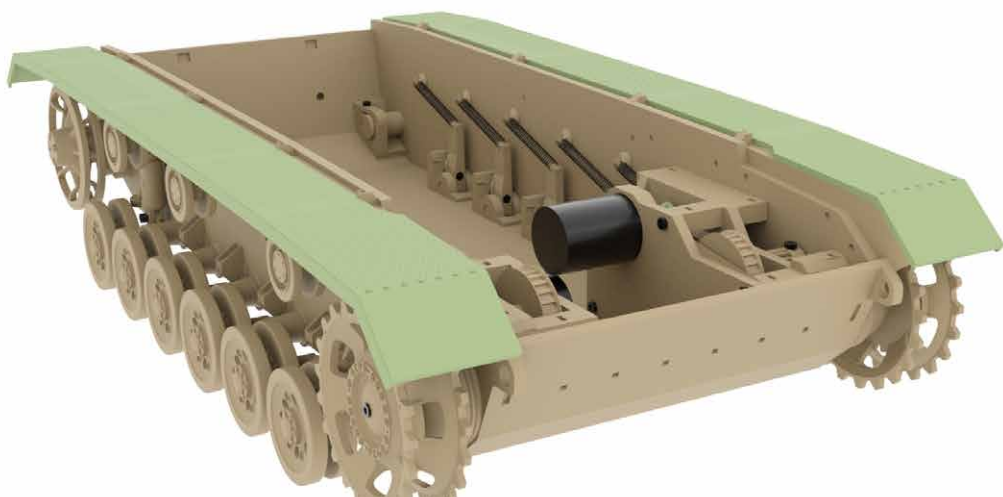

D

Soubory:
D-13-4x

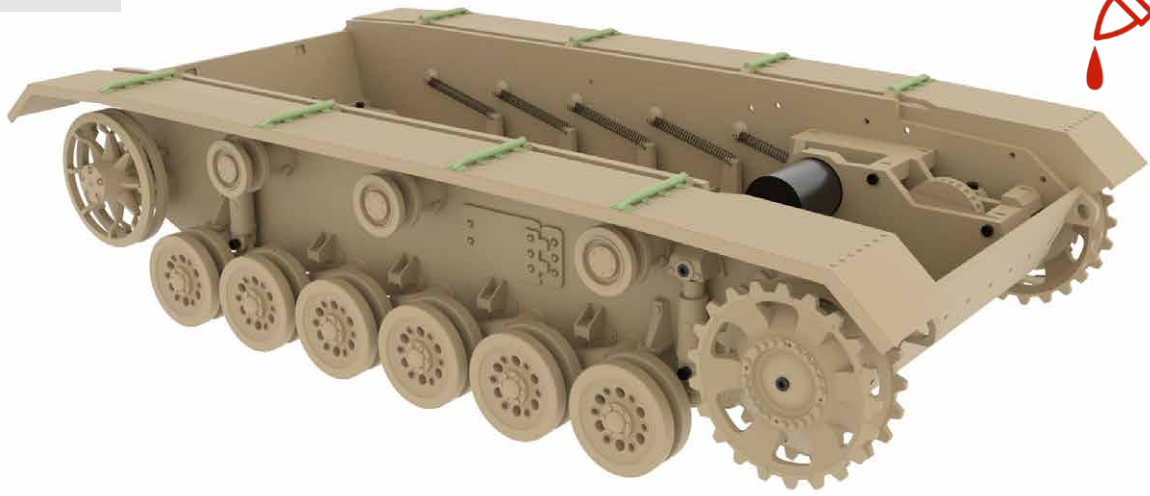

E

Soubory:
E-1-1x
E-2-1x

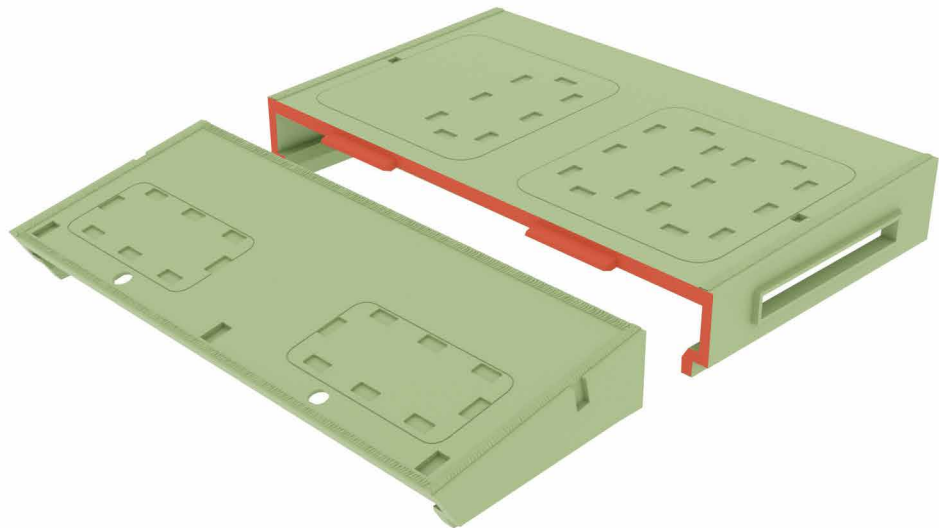

Soubory:
E-3-5x
E-4-40x

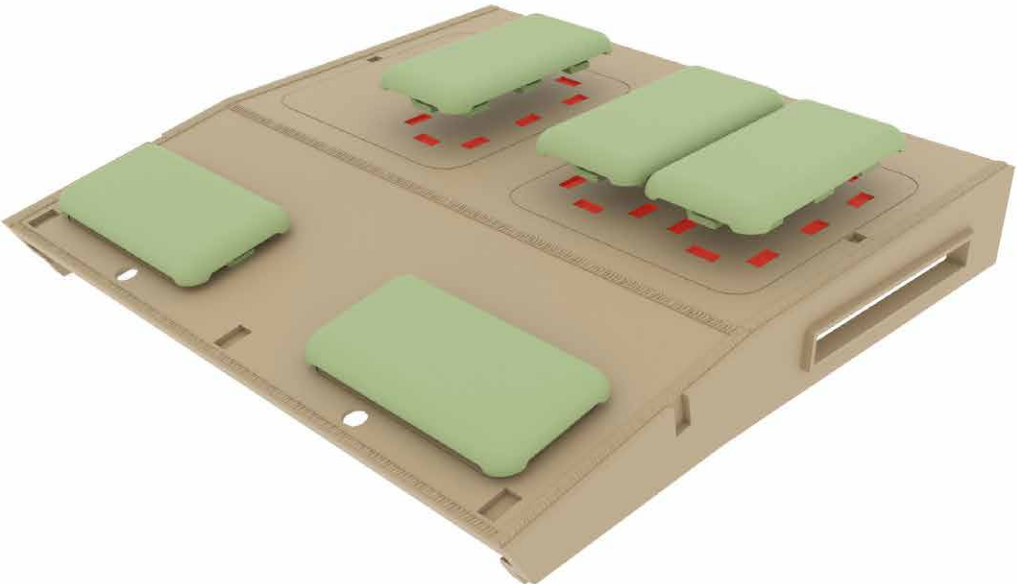
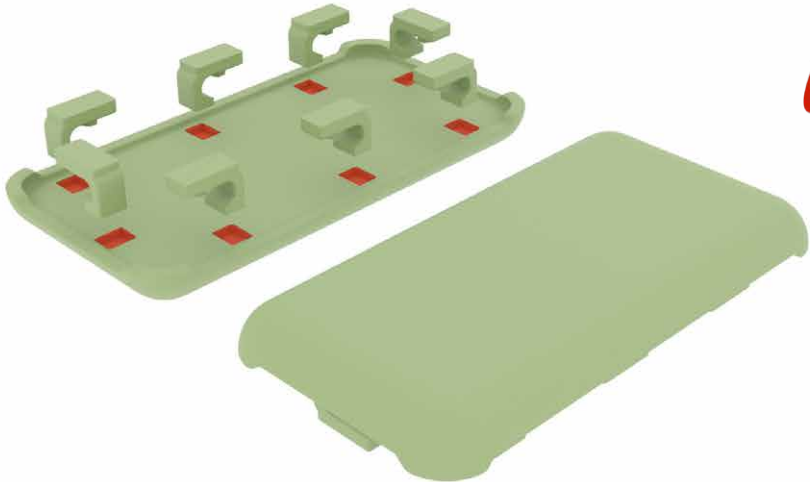

Soubory:
E-5-right-1x
E-5-left-1x
E-6-2x
E-7-right-1x
E-7-left-1x

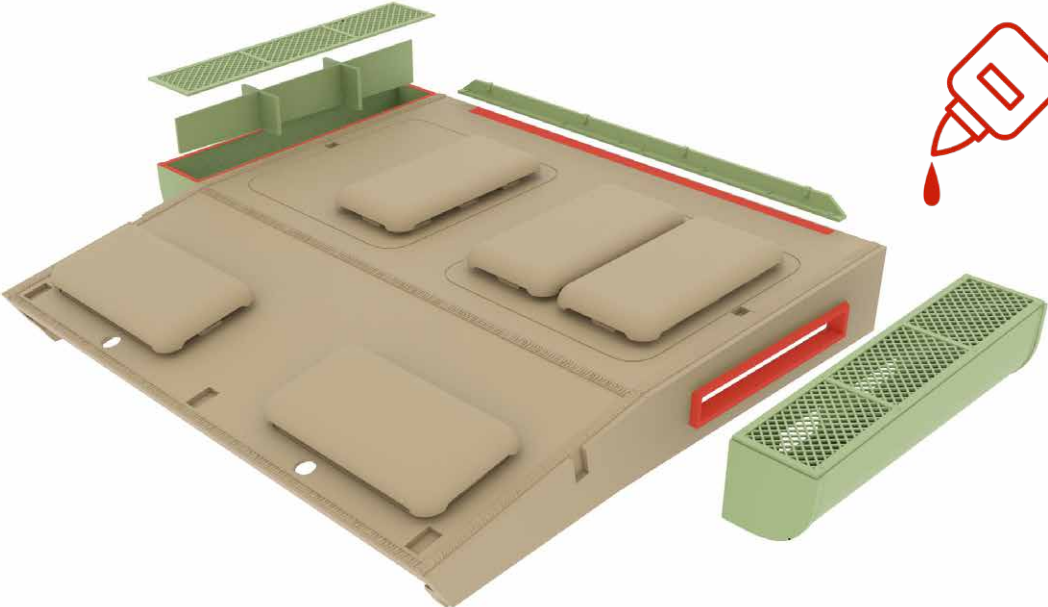

Soubory:
E-7-2x



Soubory:
E-9-1-1x
E-9-2-1x
E-9-3-2x
E-10-1x

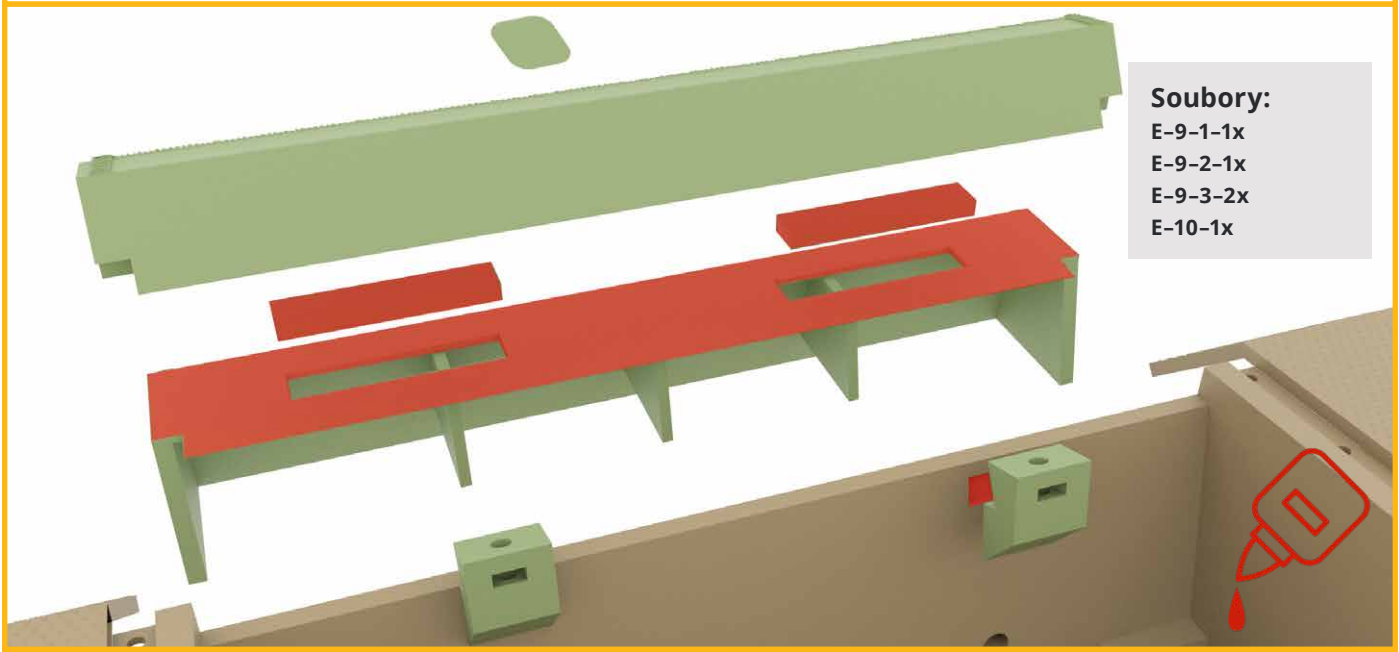

F

Soubory:

- F-1-1x
- F-2-1x
- F-3-1x
- F-4-1x
- F-5-2x



Soubory:

- F-6-5x
- F-7-right-1x
- F-7-left-1x
- F-8-right-1x
- F-8-left-1x
- F-9-3x

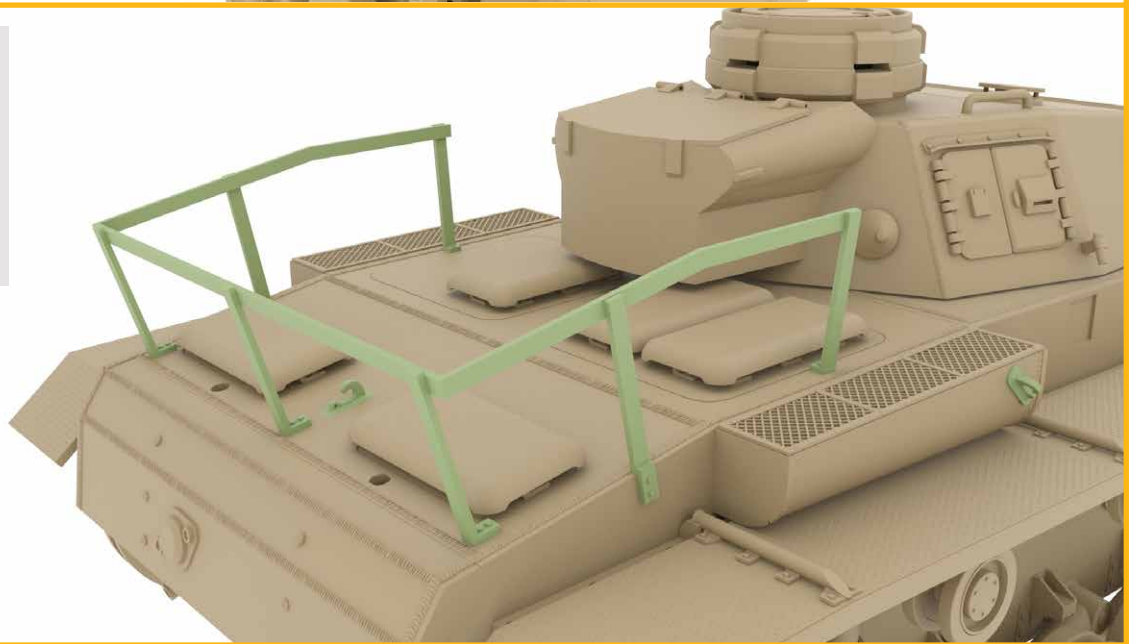

Soubory:

- F-10-2x
- F-11-1x
- F-12-2x
- F-13-1x
- F-14-2x
- F-15-1x
- F-16-1x
- F-17-1x
- F-18-1x
- F-19-1x
- F-20-1x
- F-21-1x
- F-22-1x
- F-23-1x
- F-24-1x
- F-25-1x
- F-26-1x

- G-1-19x
- G-2-19x



Soubory:

G-1-188x

G-2-188x

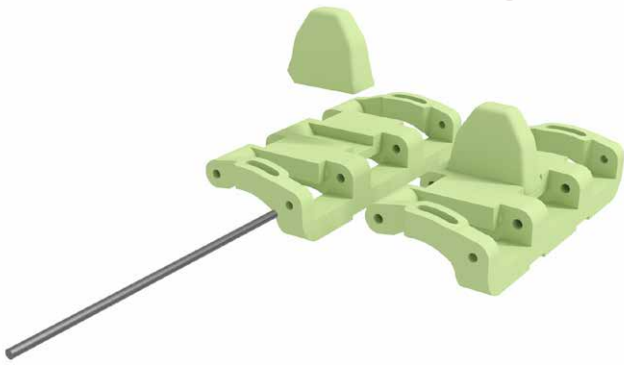

Soubory:

G-3-right-94x

G-3-left-94x

G-2-188x

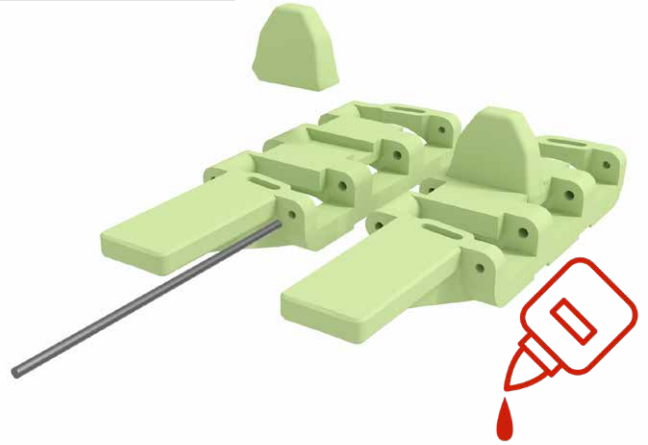



autor: **Petr Školař**
web: **www.3dtiks.store**
e-mail: **3dtisk@gpstudio.cz**