

VERZE 1.2.

2024



Sturmgeschutz III

StuG III Ausf.
1:10

F



BUILD GUIDE

www.3dtisk.store

Build Guide

3d print

Settings :

Print setting: 0.20mm (for connecting parts 0.15mm more accurate, e.g. inserting ball bearings)

Filling: 15% (for moving parts 100%, e.g. gearbox)

Filament: **PLA 3 Kg**

STL files: **223 pcs**

Print duration: **9 days**

UPDATE V-1.2.

combined gearbox, stronger drive axle, easier assembly, replaceable parts, new belt tensioner

Spojovací materiál

Screws

M3 x 16mm = 66pcs

M3 x 10mm = 8pcs

Ball-bearing:

Ball-bearing 10 x 15 x 4mm = 20pcs

Ball-bearing 12 x 21 x 5mm = 4pcs

70 XL Timing belt

teeth: 35 = 4pcs

Springs:

0,5 mm, 30 mm, 5 mm = 12pcs

Binding wire: tl. 1 mm

Super glue

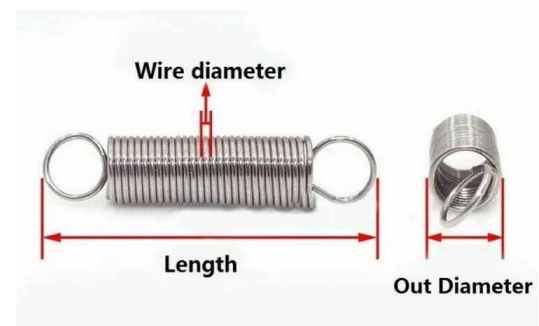

Engines:

DC motors 540

Dimensions (\varnothing x d) 35.8 mm x 50 mm

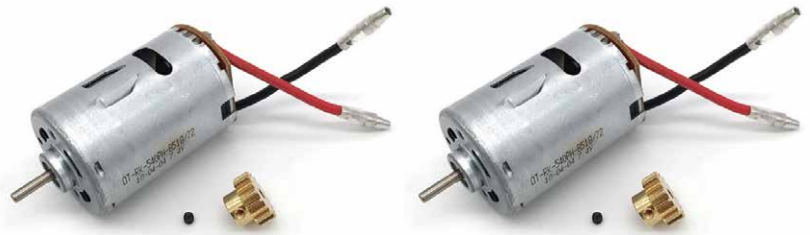

Regulators:

bidirectional electric speed controller, for DC motors.

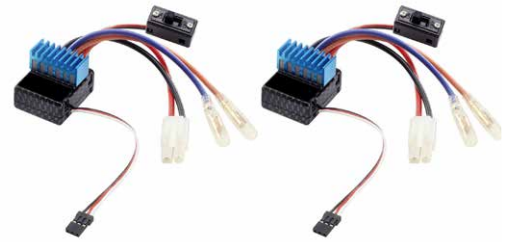

Serve:

20,3 x 38x 40,5mm



CONTROL WIRING DIAGRAM

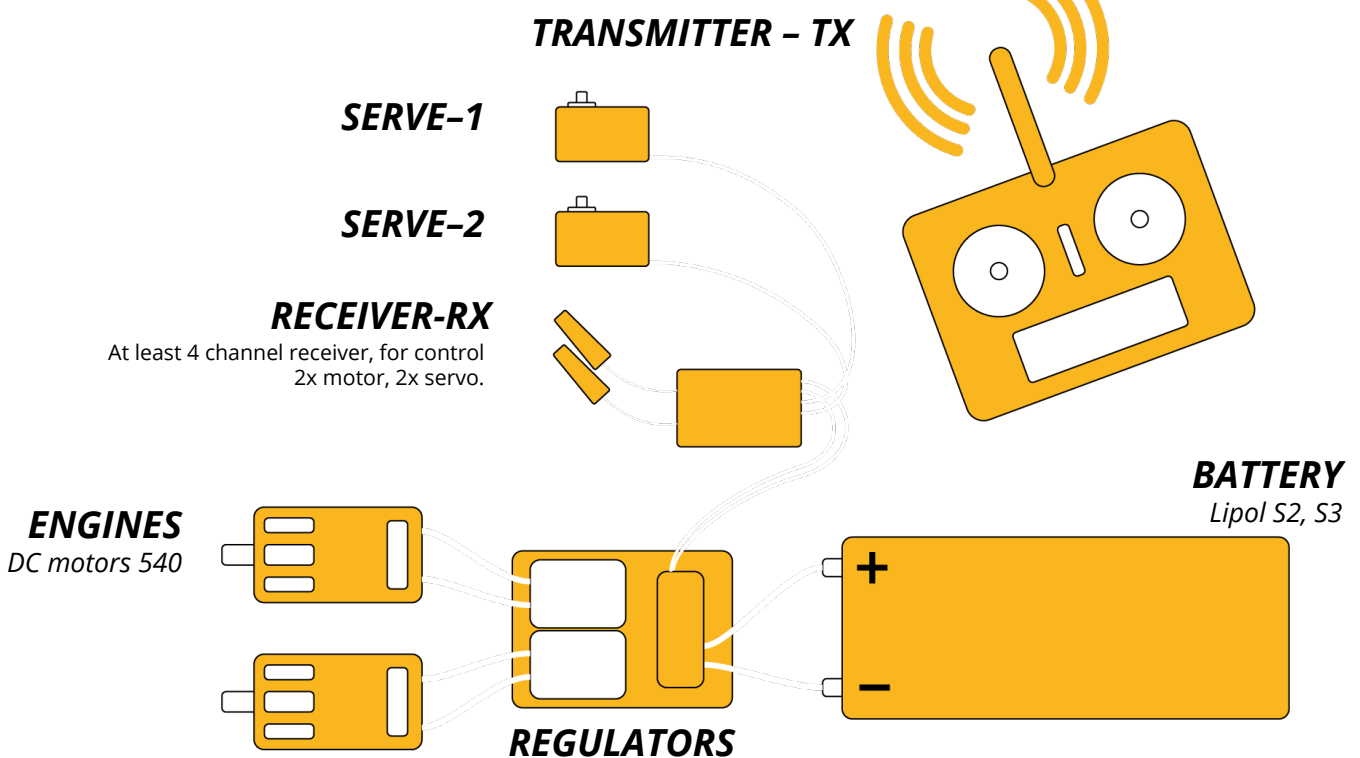

Sturmgeschütz III

StuG III - F

MODEL PARAMETERS

Scale: 1:10

Dimension: 706 x 344 x 260 mm

Weight: 4,5 Kg



A

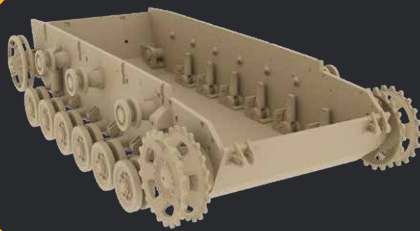

E



B



F

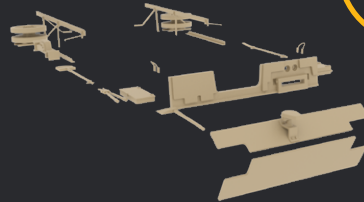

C



G



D

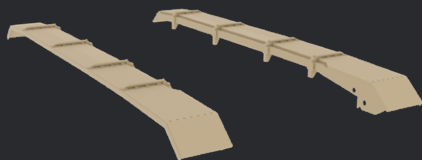

P



StuG III

A

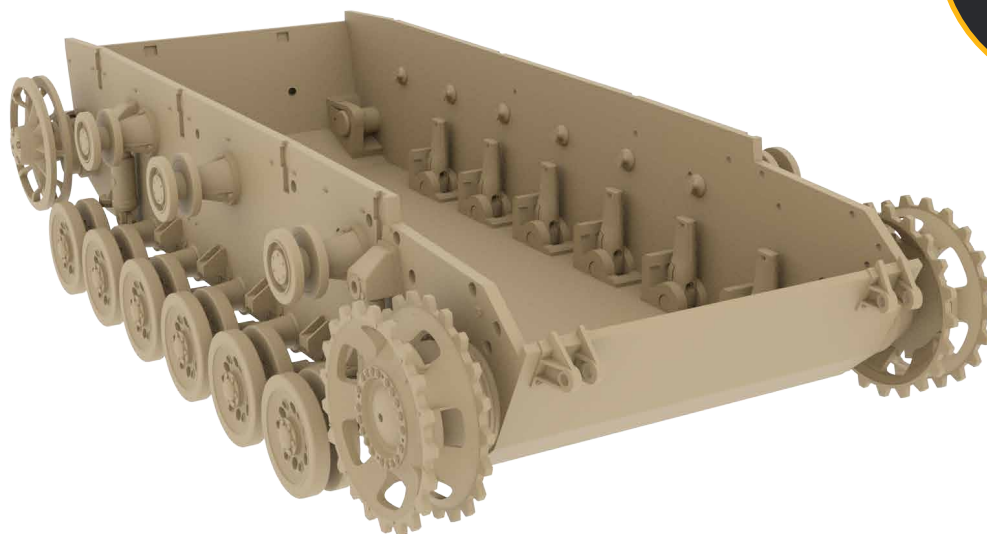

Files:

- A-1-1x
- A-2-1x
- A-3-1x

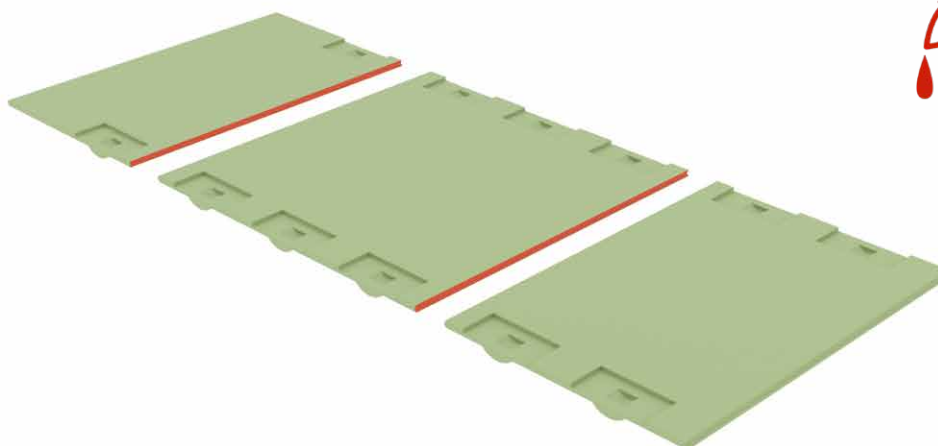

Files:

- A-4-right-6x
- A-4-left-6x
- A-5-right-6x
- A-5-left-6x

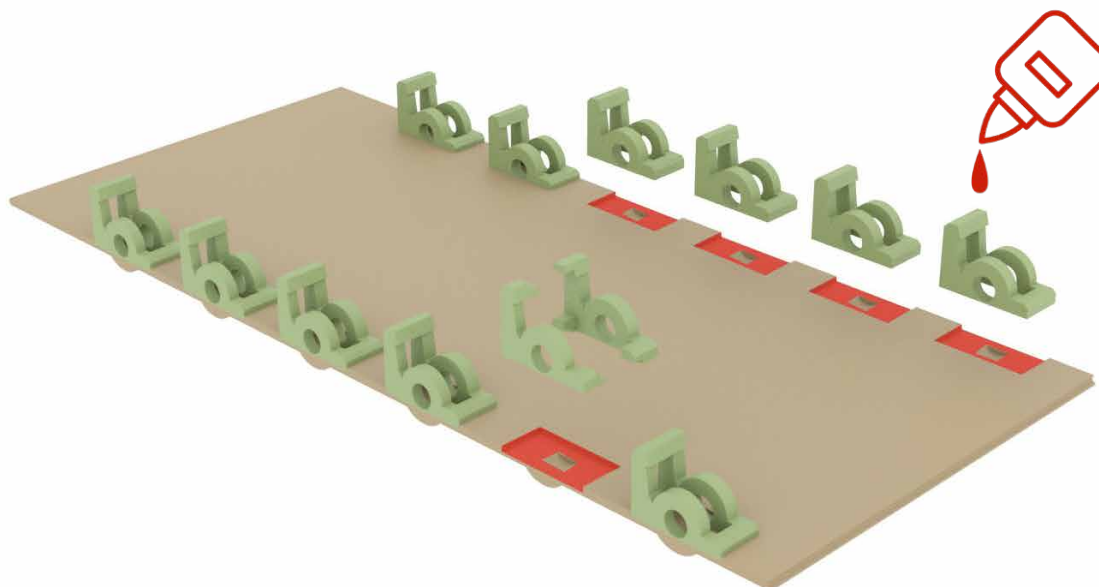

Files:

- A-6-right-1x
- A-6-left-1x
- A-7-right-1x
- A-7-left-1x
- A-8-right-1x
- A-8-left-1x

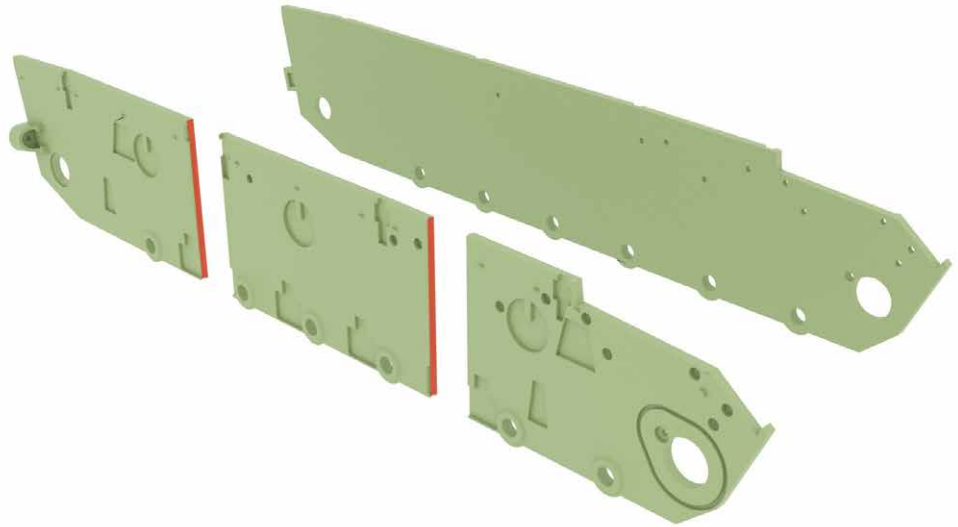

Files:

- A-11-1x
- A-12-left-1x
- A-12-right-1x

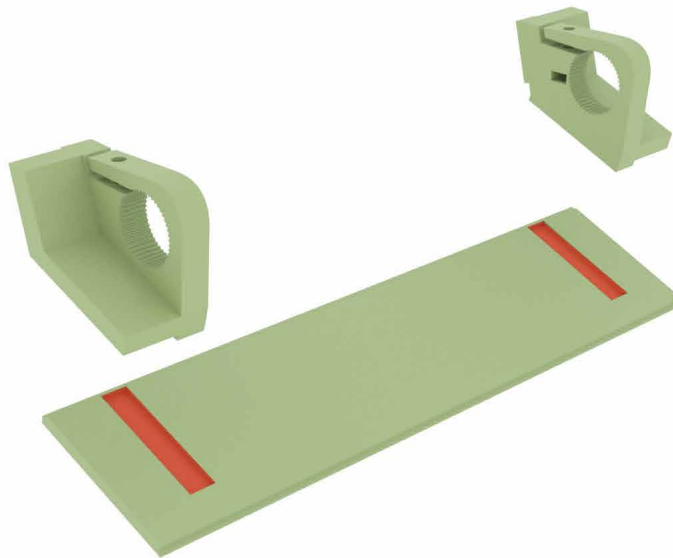

Files:

- A-9-1x
- A-10-1x
- A-11-1x
- A-12-left-1x
- A-12-right-1x
- A-13-1x

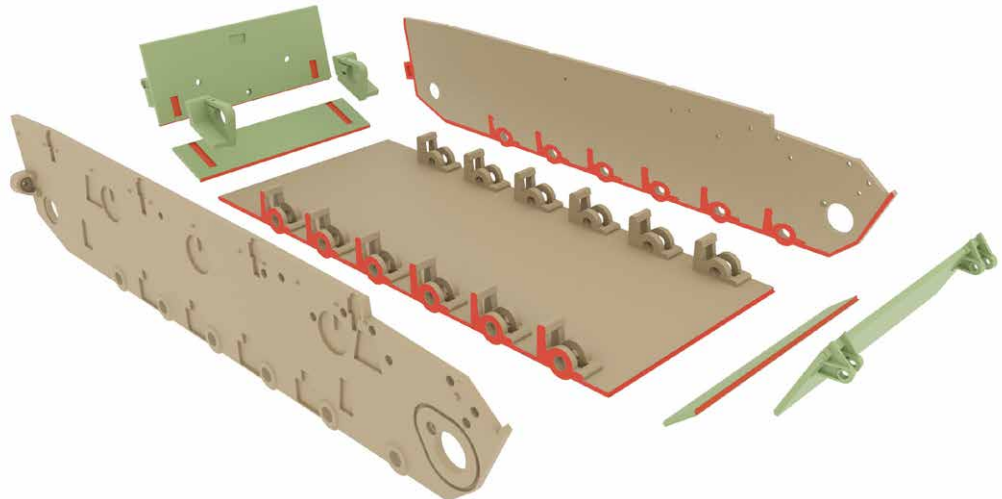

Files:
A-14-4x
A-15-FLEX-4x

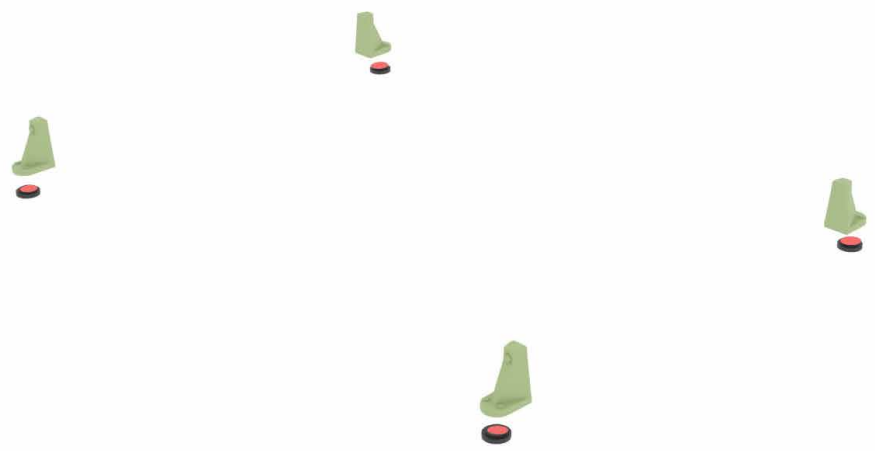

Files:
A-14-4x
A-15-FLEX-4x
A-16-8x
A-17-6x
A-18-4x
A-19-right-1x
A-19-left-1x
A-19-2-2x
A-20-2x

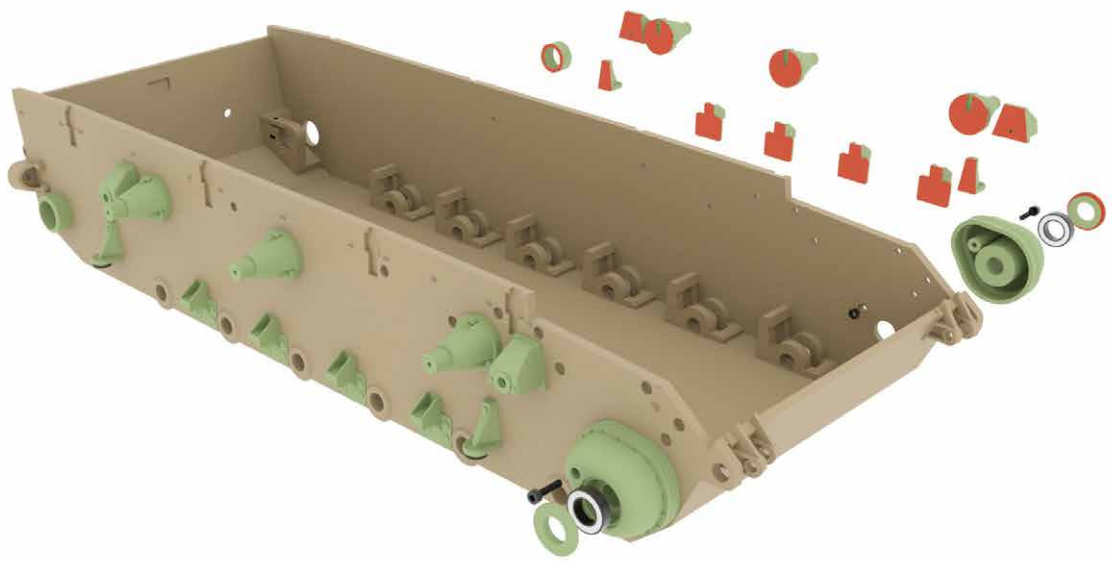

Files:
A-21-6x
A-22-6x
A-23-6x
A-24-6x
A-24-FLEX-12x

M3 16mm 12x

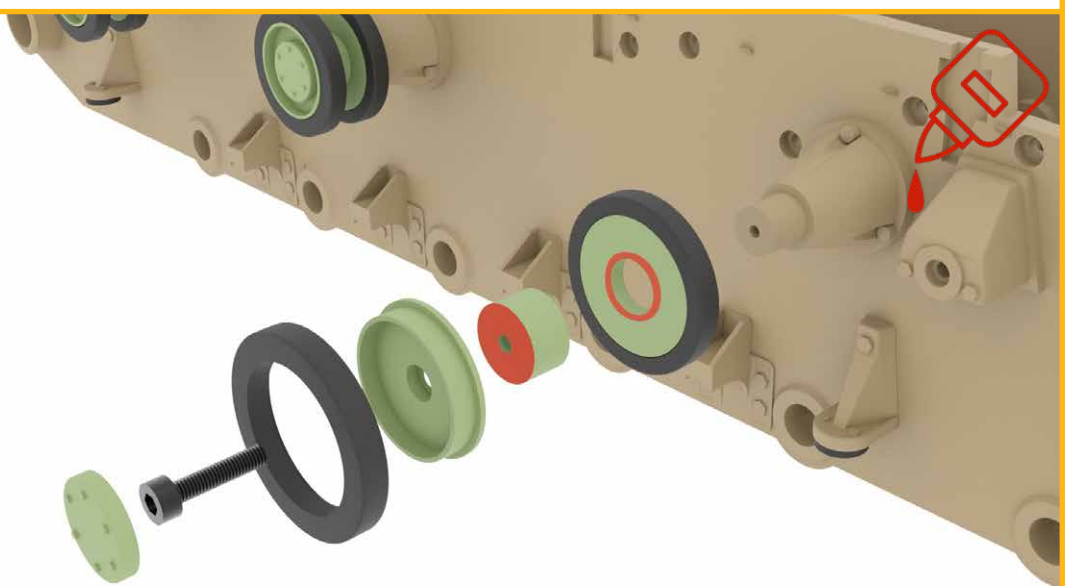

Files:

A-25-12x

A-26-12x

A-27-12x

A-28-12x

A-29-FLEX-12x

Bearings

10x15x4 mm

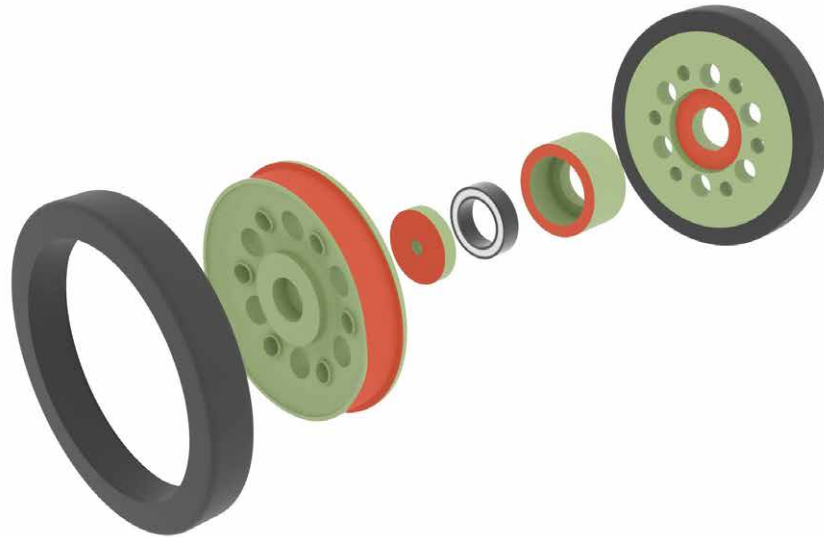
**Files:**

(A-25-12x, A-26-12x, A-27-12x, A-28-12x, A-29-FLEX-12x)

A-30-12x

A-31-right-2x

A-31-left-2x

A-32-right-4x

A-32-left-4x

A-32-12x

**Files:**

A-33-4x

A-34-4x



Files:
A-35-right-6x
A-35-left-6x

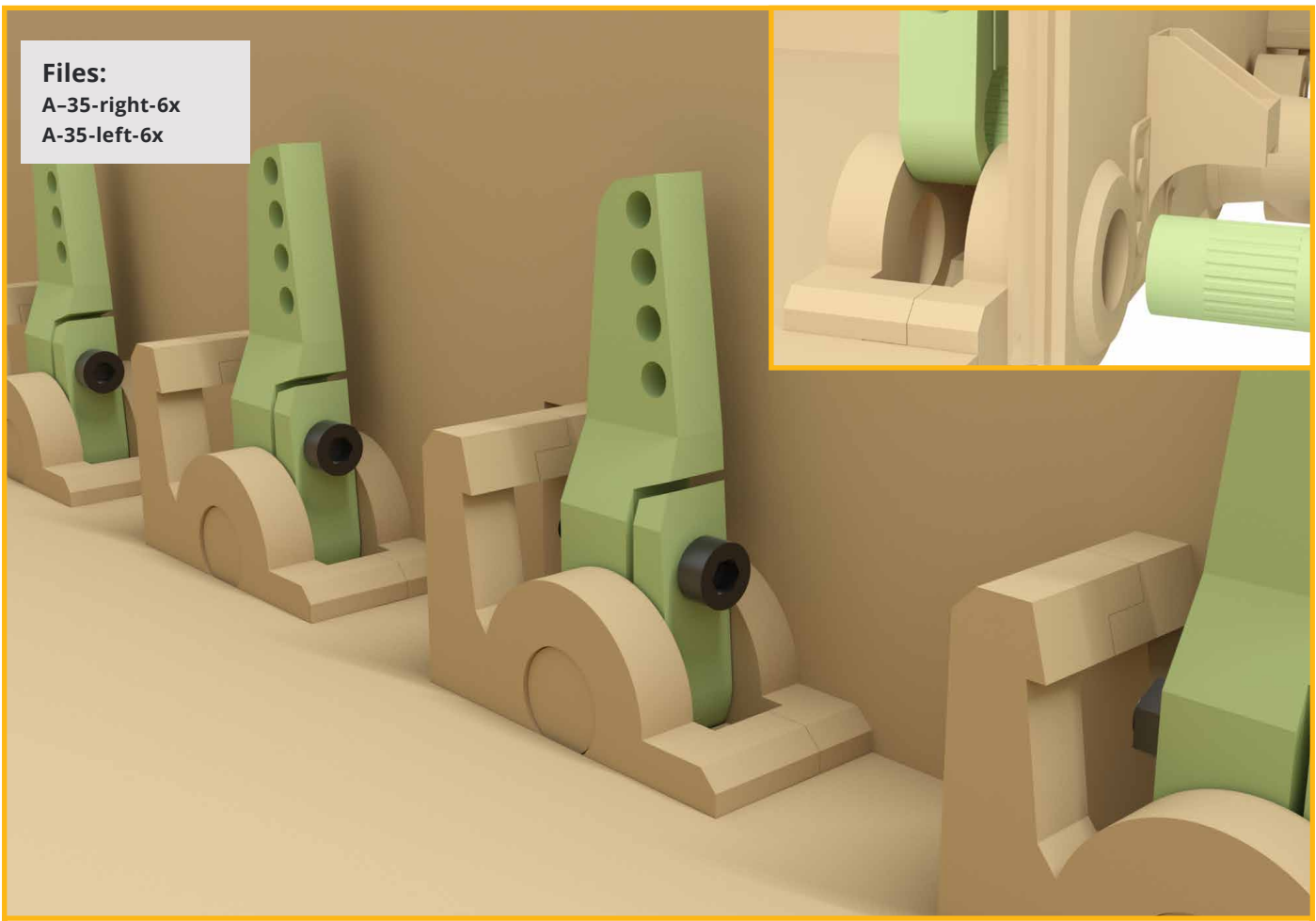

Files:
A-36-12x
Springs



Files:

- A-37-2x
- A-38-2x
- A-39-2x
- A-40-2x
- A-41-2x
- A-42-2x

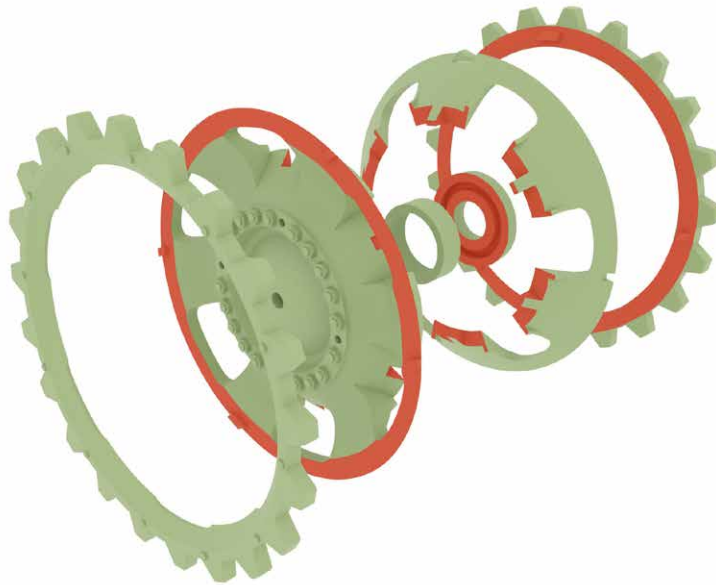

Files:

- A-43-2x
- A-44-4x
- A-45-2x
- A-46-2x
- A-47-6x

Bearings
10x15x4 mm

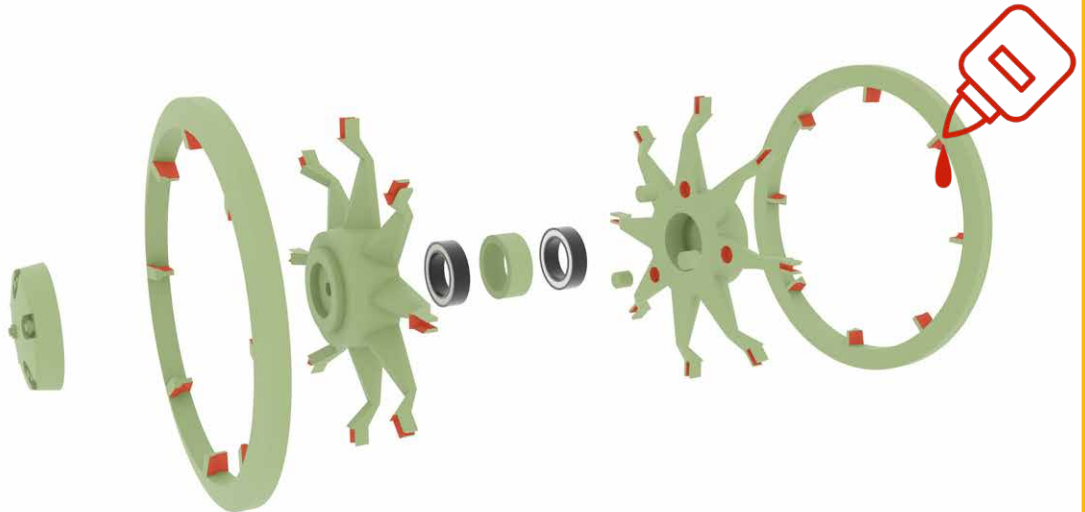

Files:

- A-49-2x
- A-50-left-1x
- A-50-right-1x
- A-51-2x
- A-52-2x



Files:
A-48-2x

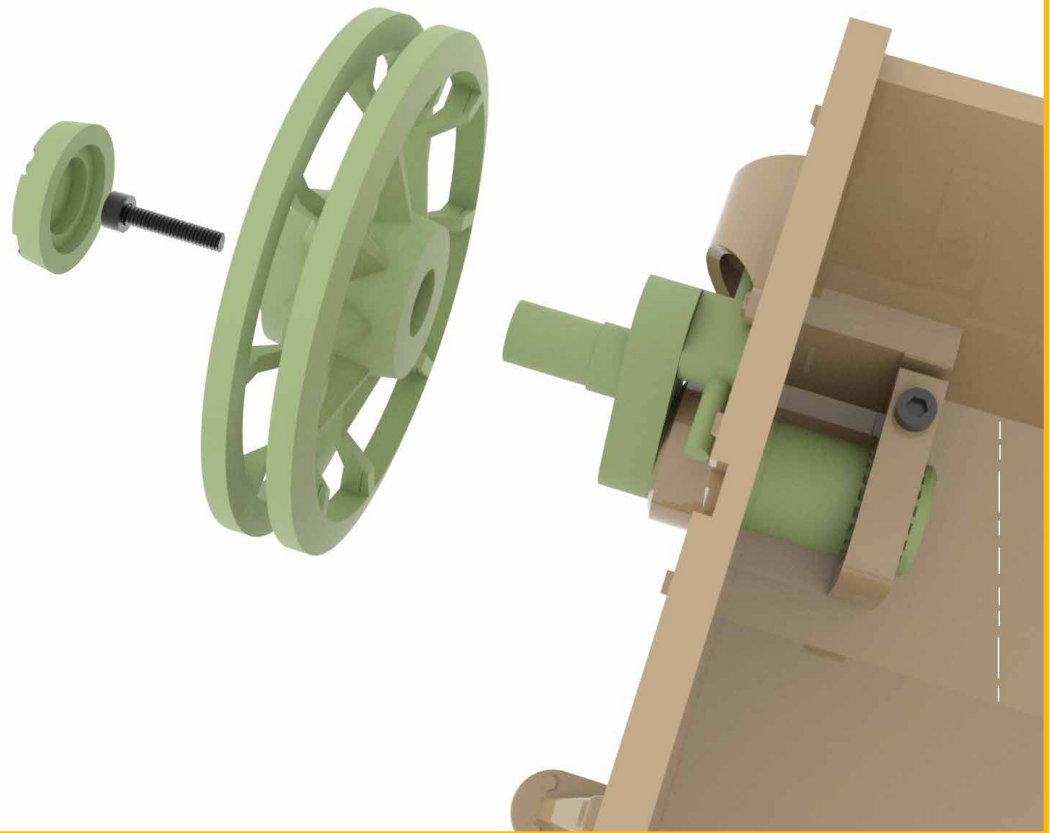

Files:
A-53-left-1x
A-53-right-1x
A-54-left-1x
A-54-right-1x
A-55-1x
A-56-1x
A-57-1x

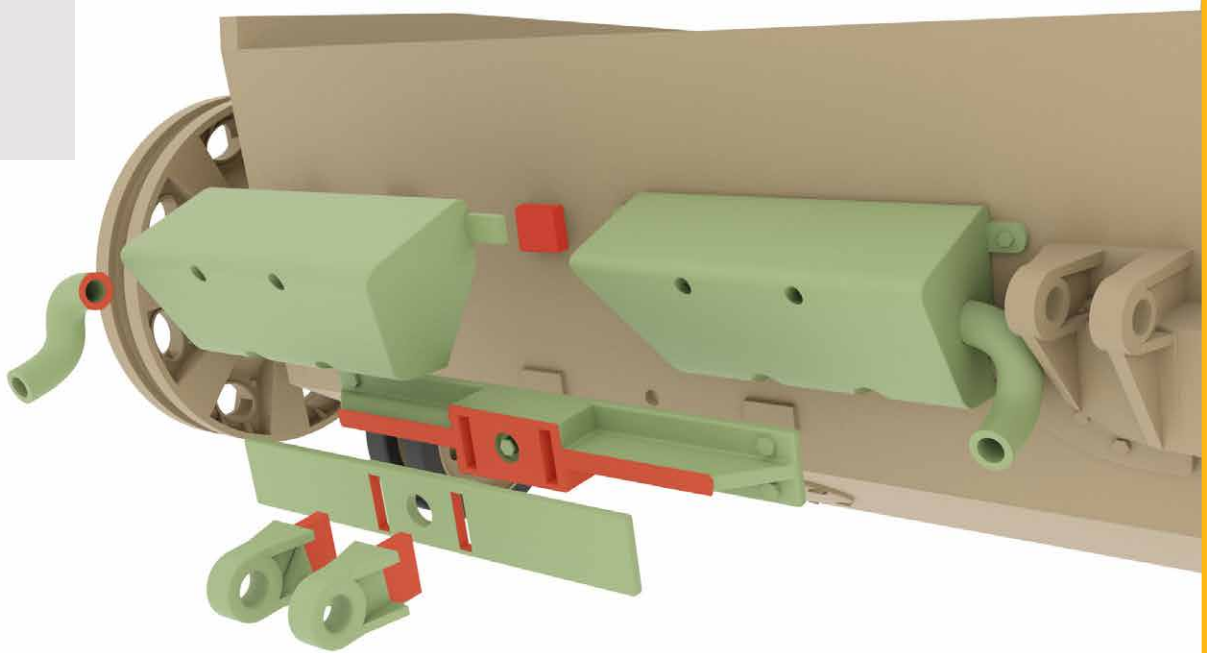

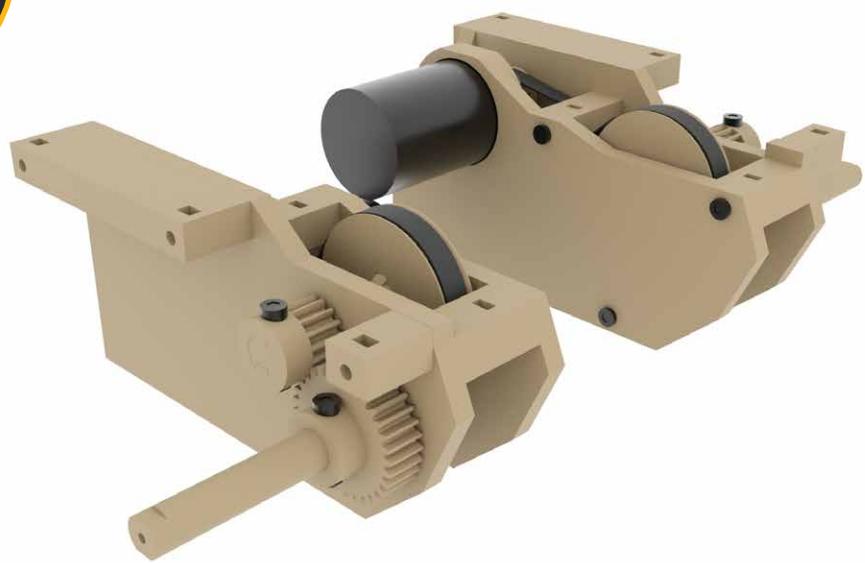

- Files:**
P-1-right-1x
P-1-left-1x
P-2-right-1x
P-2-left-1x
P-3-right-1x
P-3-left-1x

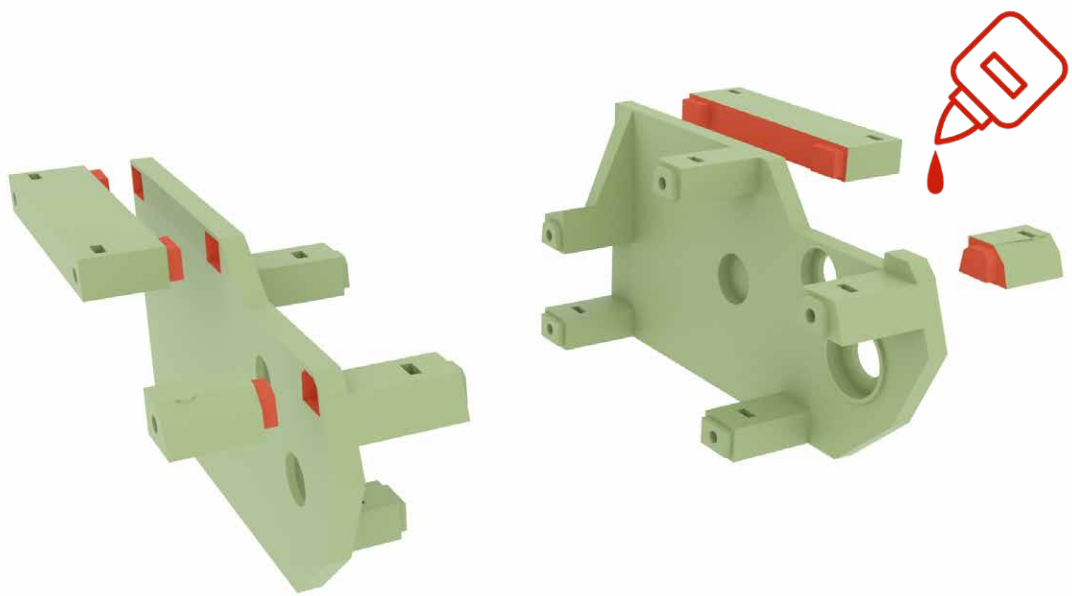

- Files:**
P-4-2x
P-5-2x
M3 16mm 2x
Bearings-
12x21x5mm-2x

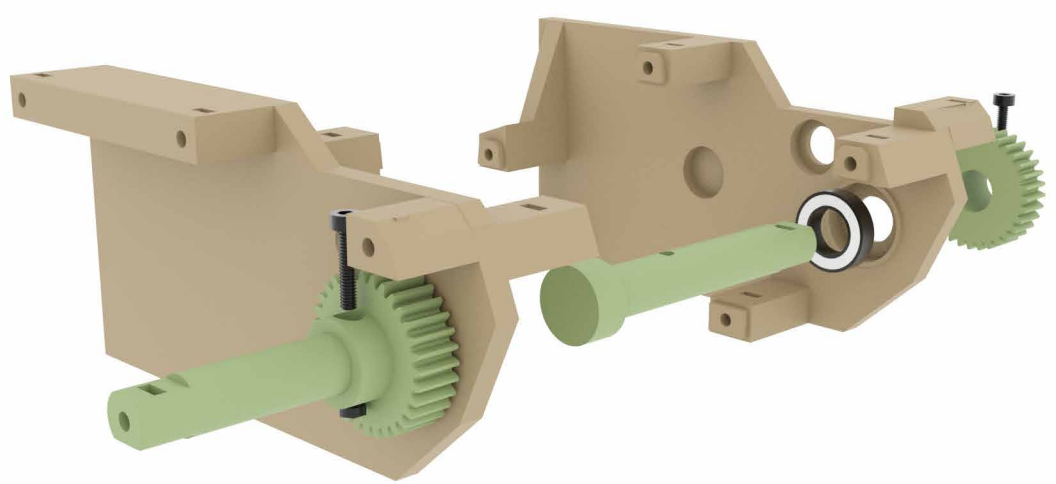

Files:

- P-6-2x
- P-7-2x
- P-8-2x
- P-9-2x
- P-10-2x

- Bearings-
10x15x4mm-4x
- M3 16mm 2x

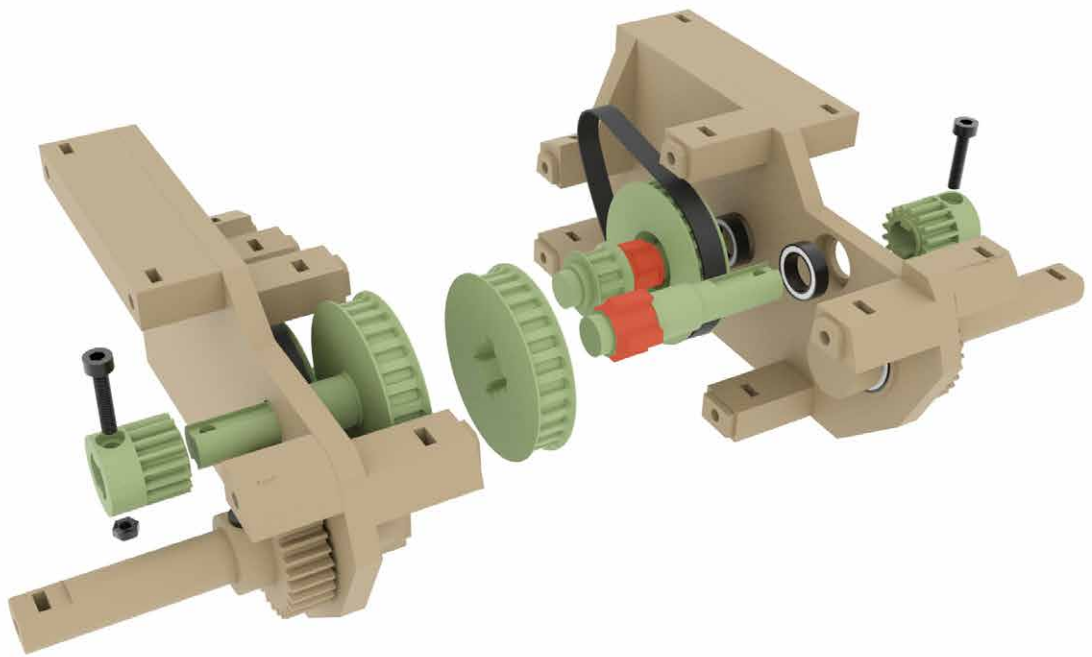

Files:

- P-11-2x
- P-12-right-1x
- P-12-left-1x

- M3 16mm 2x
- Bearings
10x15x4mm-4x

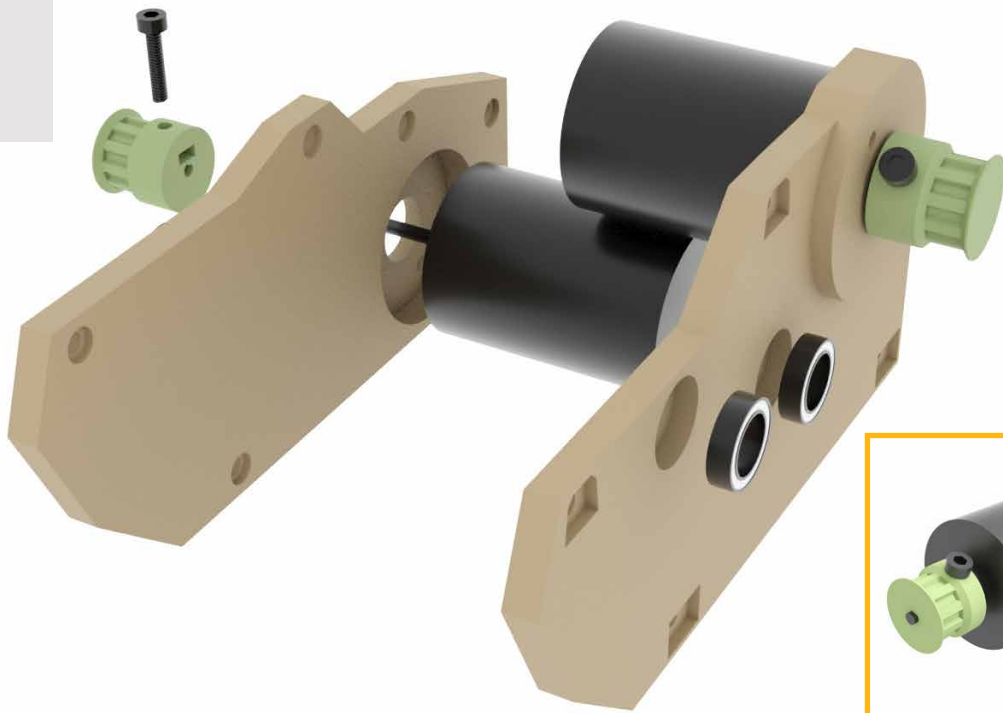

Files:
M3 16mm 12x

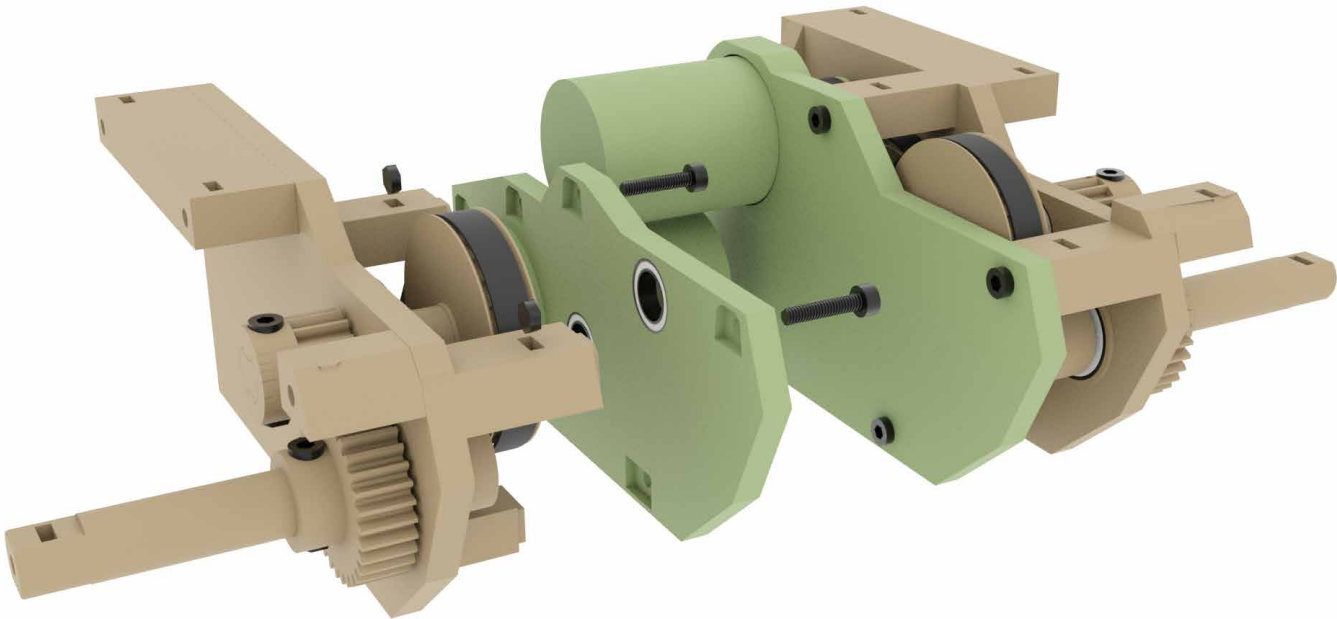

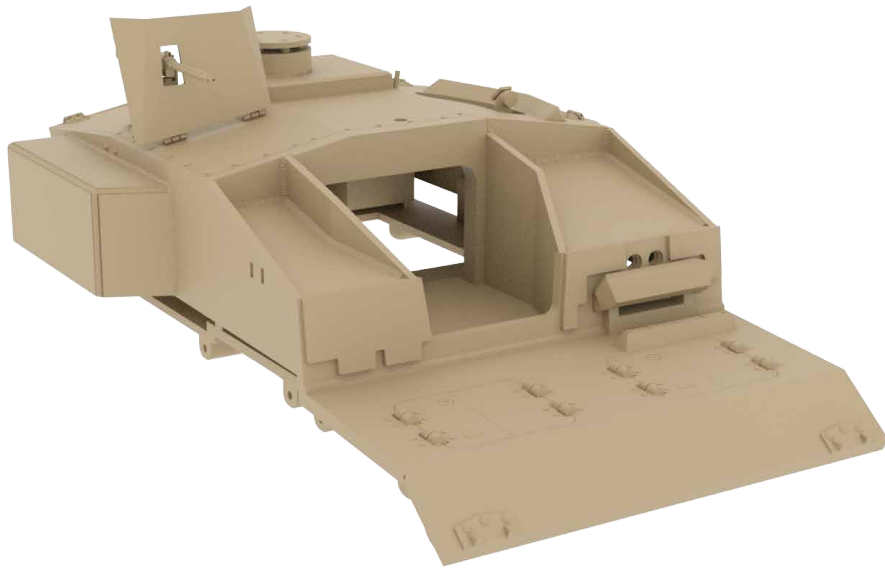

Files:

- B-1-1x
- B-3-right-5x
- B-3-left-5x

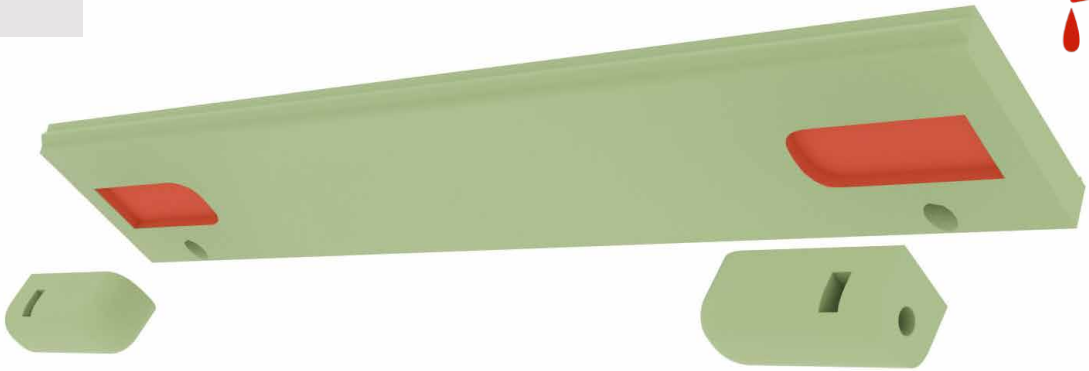

Files:

- B-2-1x
- B-3-right-5x
- B-3-left-5x
- B-4-right-1x
- B-4-left-1x

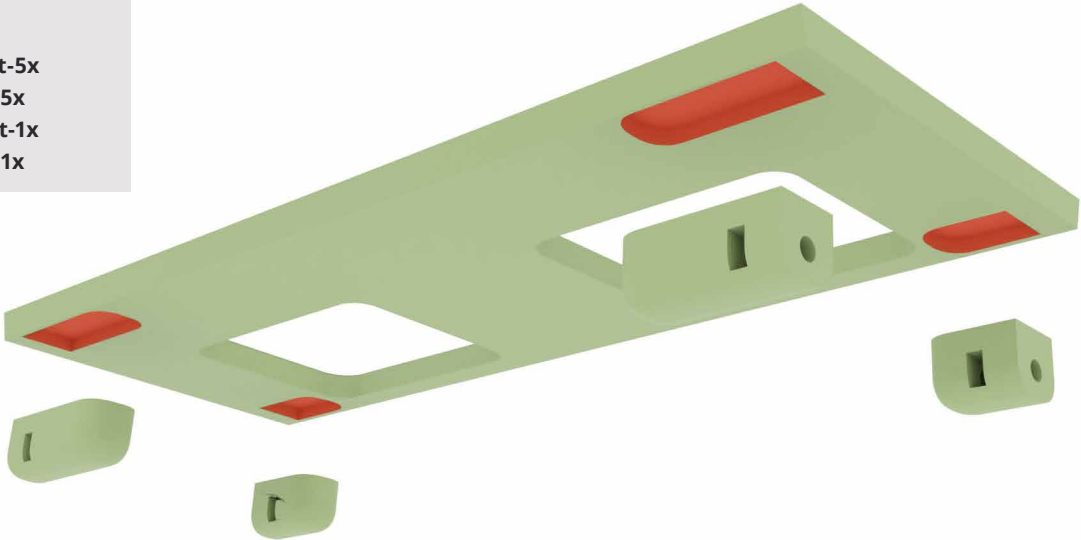

B

Files:

- B-5-right-2x
- B-5-left-2x
- B-6-right-4x
- B-6-left-4x

Wire 1mm

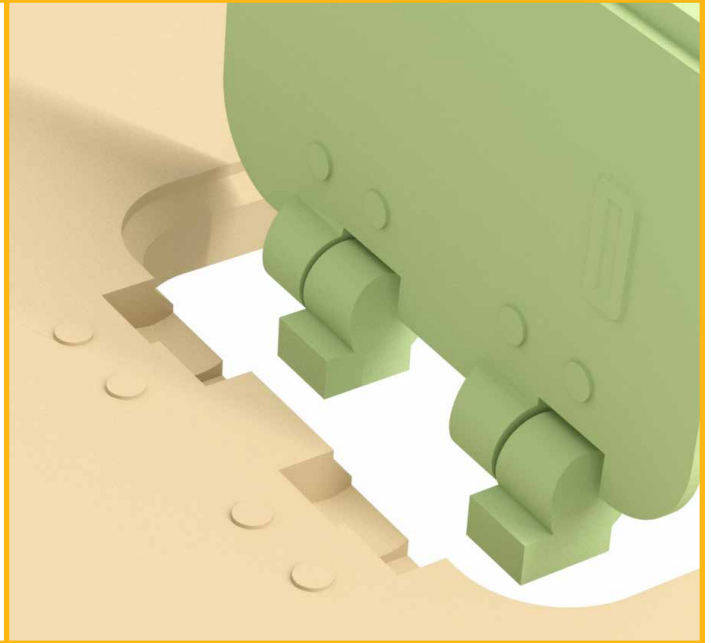
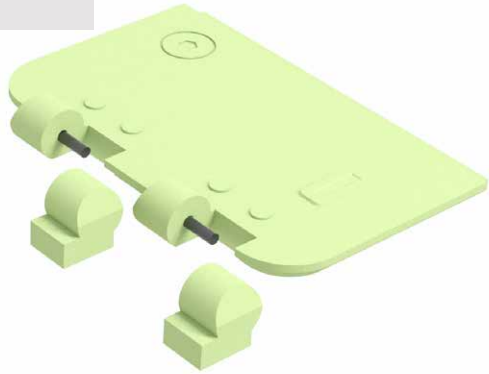

Files:

- B-5-right-2x
- B-5-left-2x
- B-6-right-4x
- B-6-left-4x
- B-7-1x

Wire 1mm

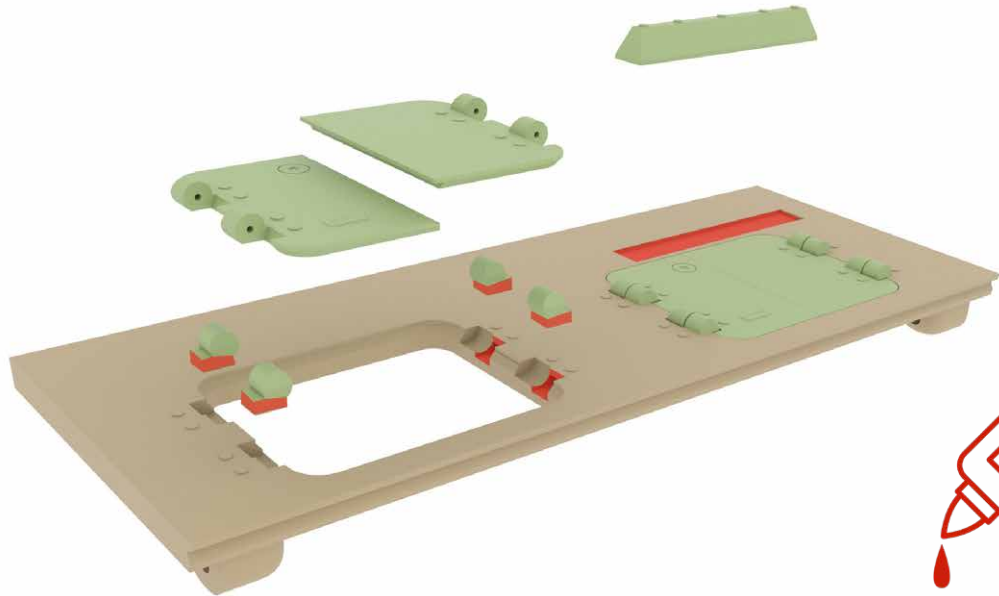

Files:

- B-8-1x
- B-9-1x
- B-3-right-5x
- B-3-left-5x

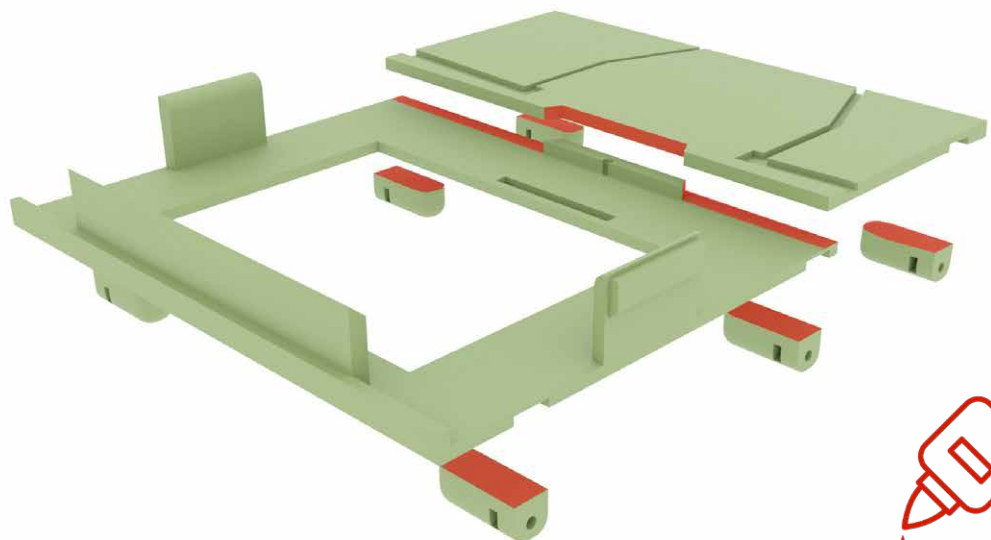

Files:
B-10-1x
B-11-1x
B-12-1x

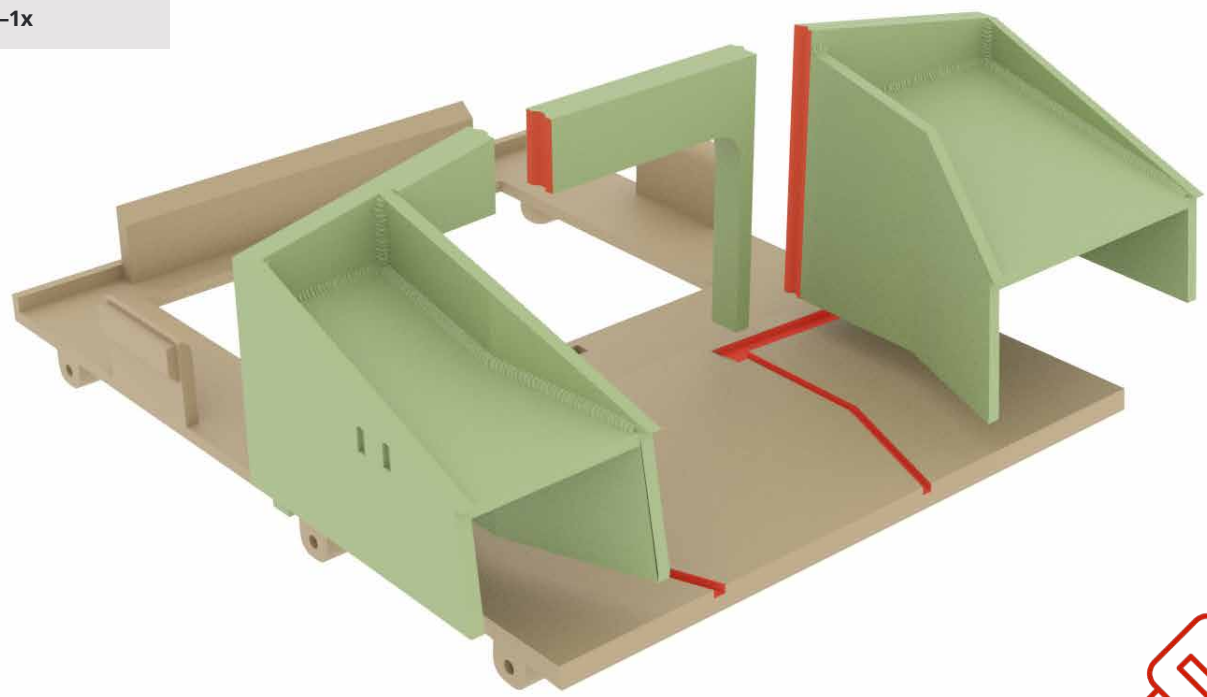

Files:
B-13-1-right-1x
B-13-1-left-1x
B-14-1x

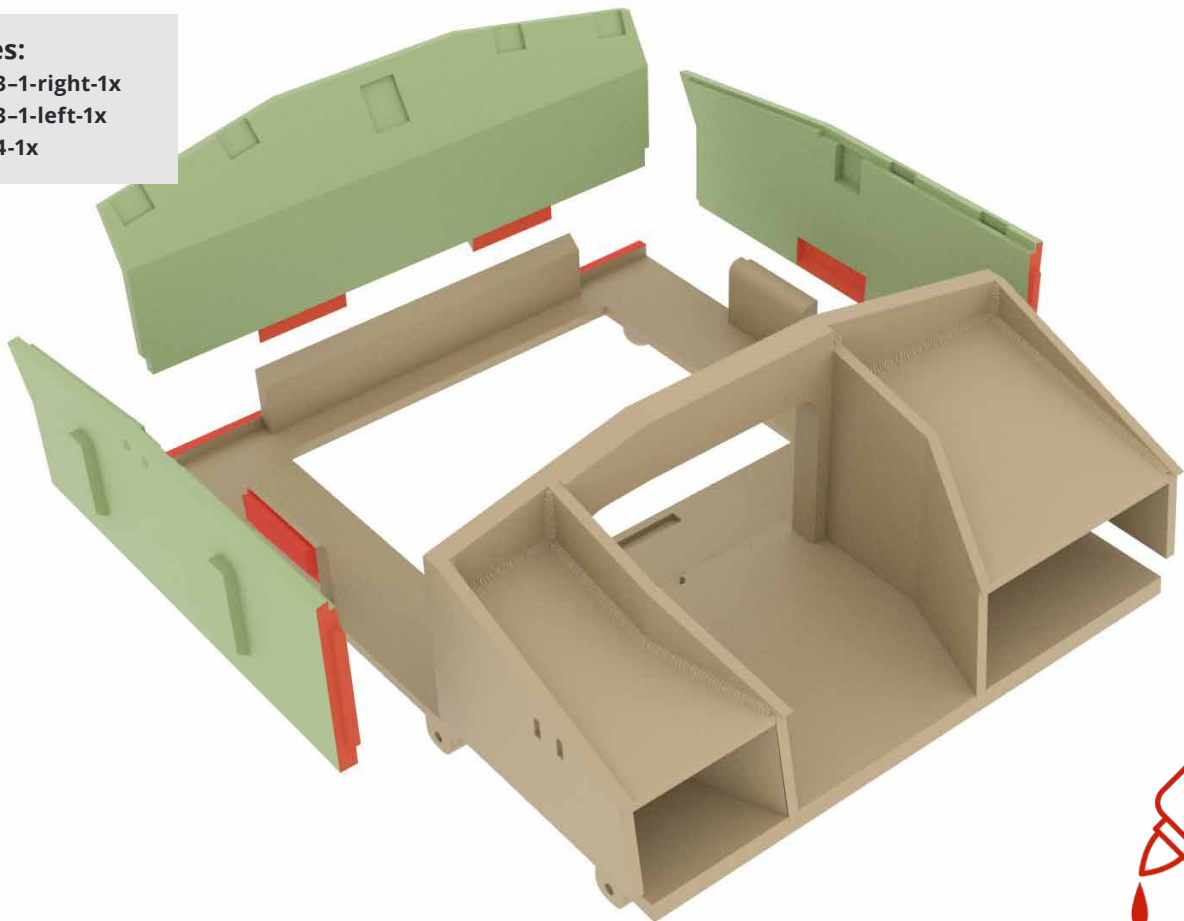

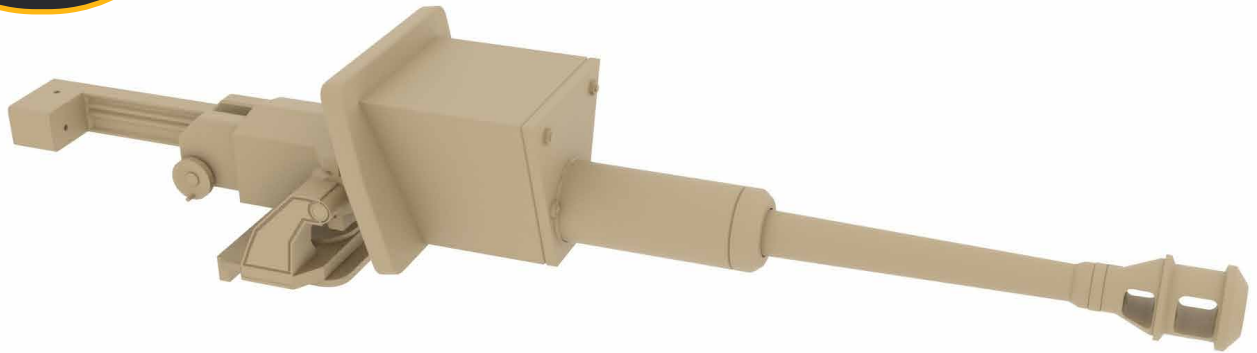

Files:

- C-1-1x
- C-2-1x
- C-3-1-1x
- C-3-2-1x



Files:

- C-4-1x
- C-5-1x
- C-6-1x
- C-7-2x

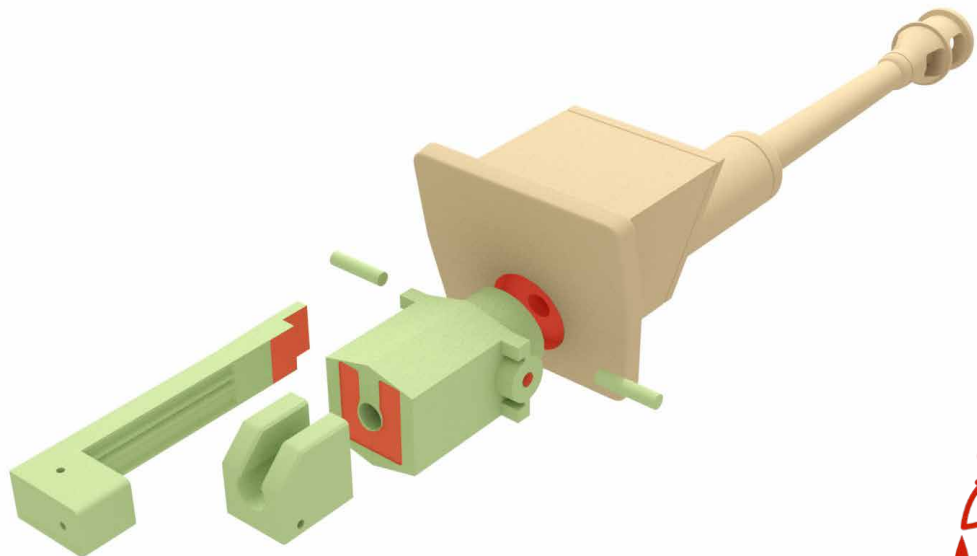

Files:
C-8-right-1x
C-8-left-1x
C-9-1x

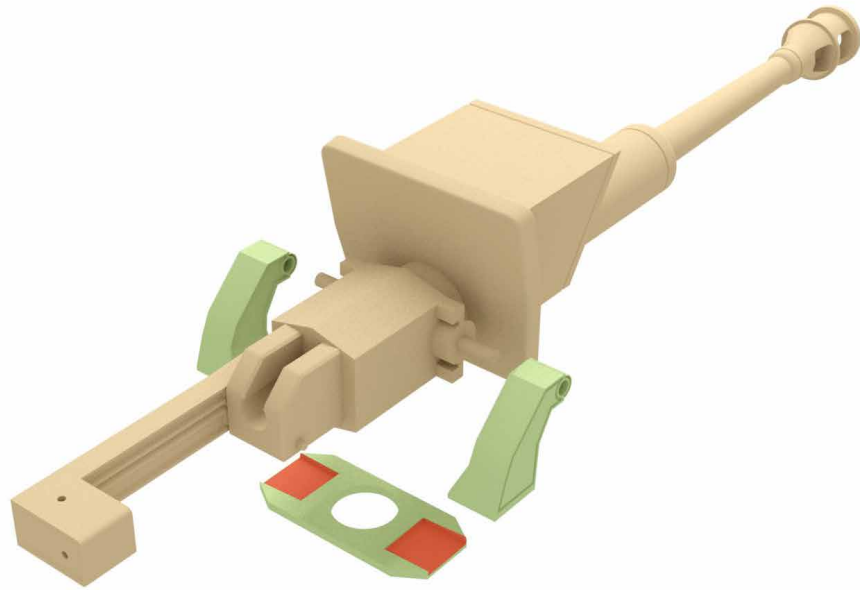

Files:
C-10-1x
C-11-1x

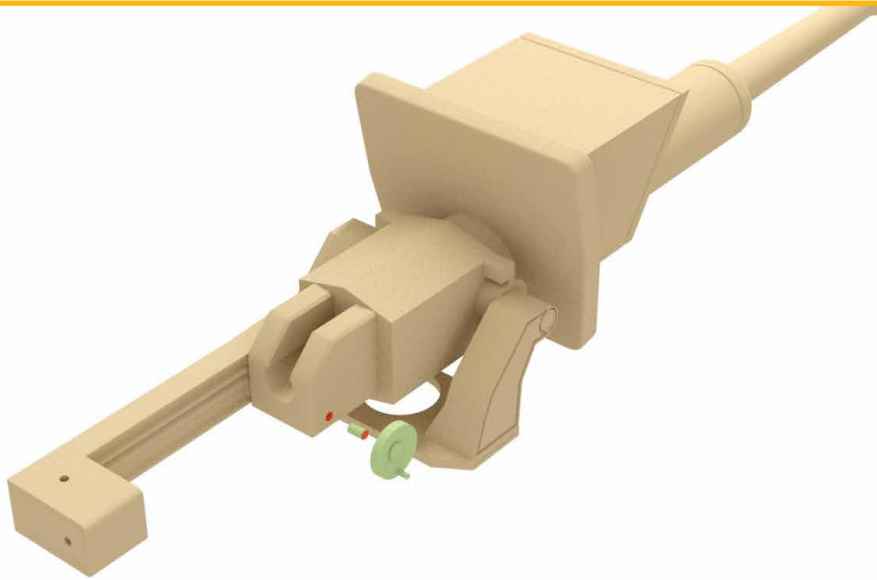

Files:
C-12-1x
C-13-1x
C-14-1x



B

Files:

- B-15-1x
- B-16-1x
- B-17-2x
- B-18-4x
- B-19-1x
- B-20-1x
- B-21-1x
- B-22-1x

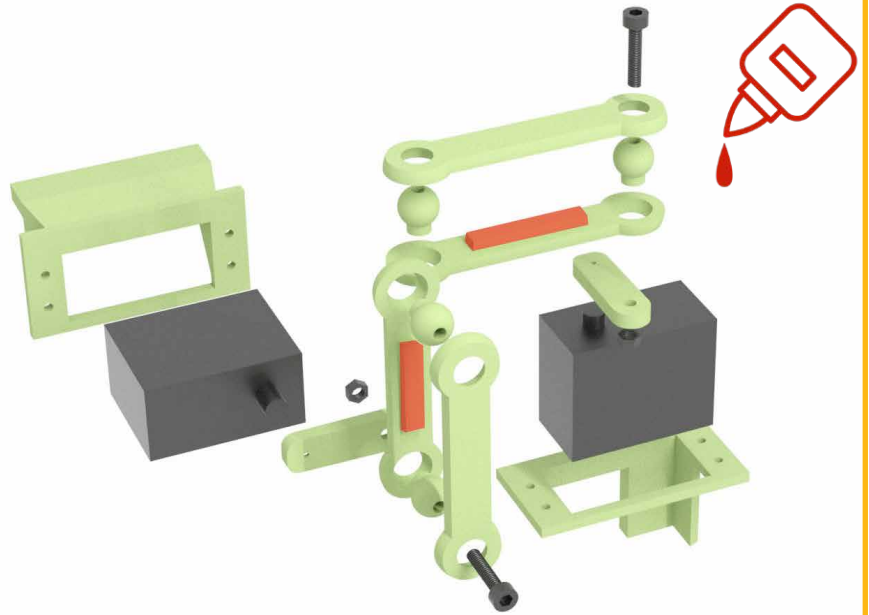

Files:

- B-23-2x
- B-24-1x
- B-25-1x



Files:
B-26-1x

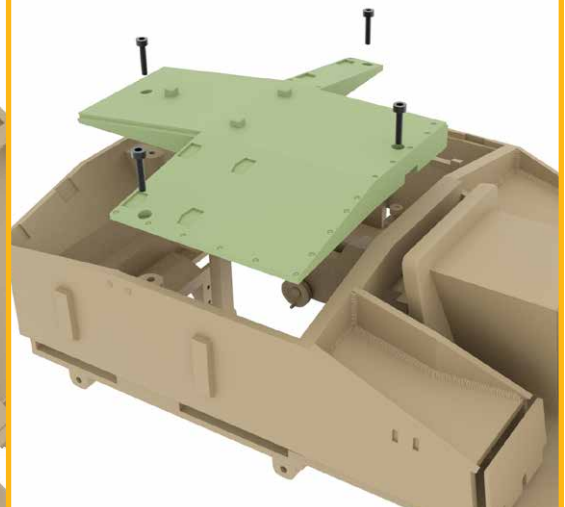

Files:

- B-27-6x
- B-28-12x
- B-29-6x
- B-29-2-6x
- B-30-right-1x
- B-30-left-1x
- B-31-right-1x
- B-31-left-1x
- B-32-1x

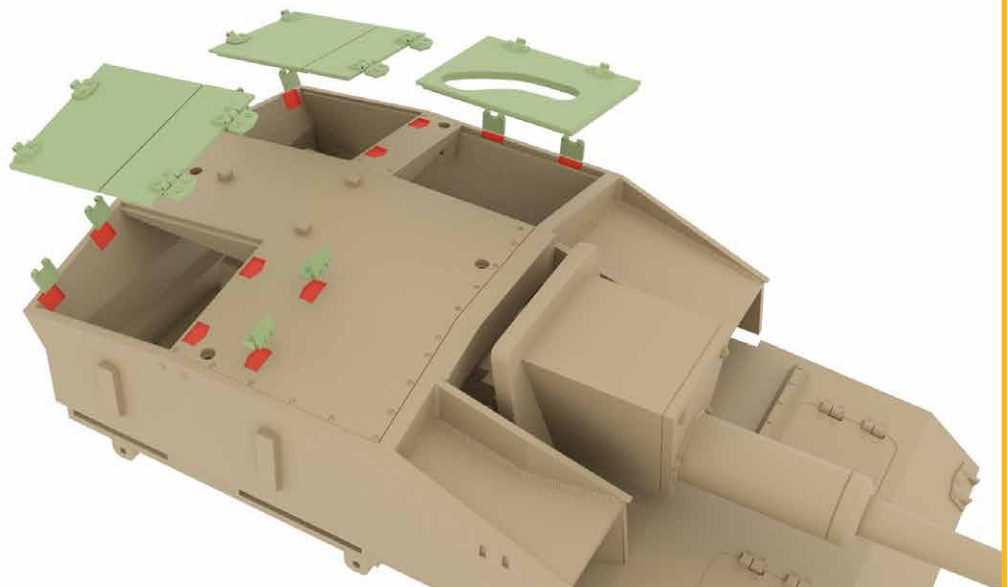

- Files:**
B-33-1x
B-34-1x
B-34-1-1x
B-34-2-1x
B-35-1x
B-36-left-1x
B-36-right-1x

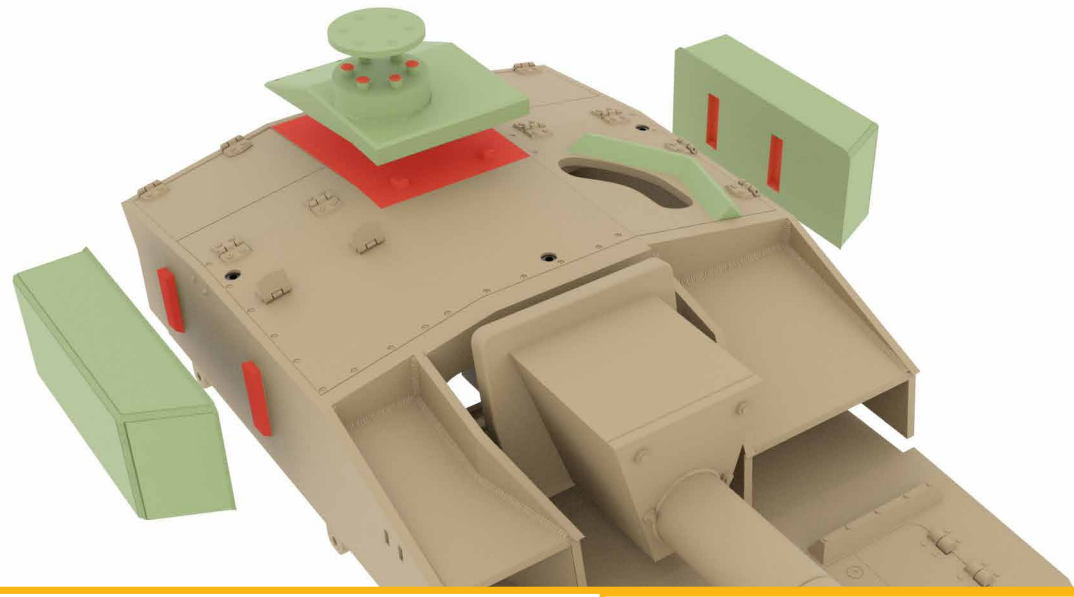

- Files:**
B-36-1x
B-37-1x

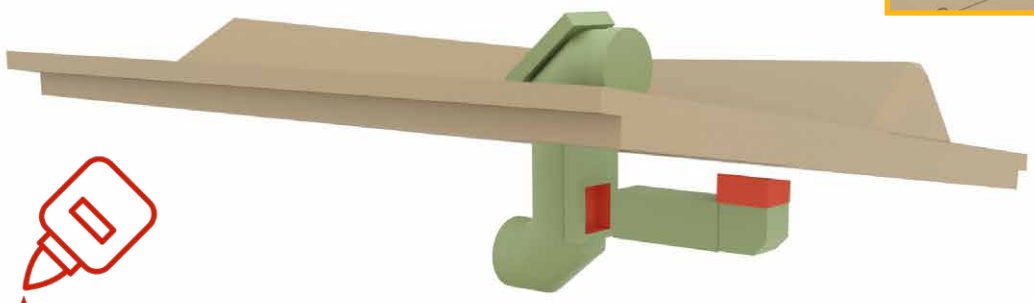

- Files:**
B-38-1x
B-39-1x
B-40-2x
B-41-1x
B-42-1x
B-43-1x
B-44-1x
B-45-1x
B-46-1x

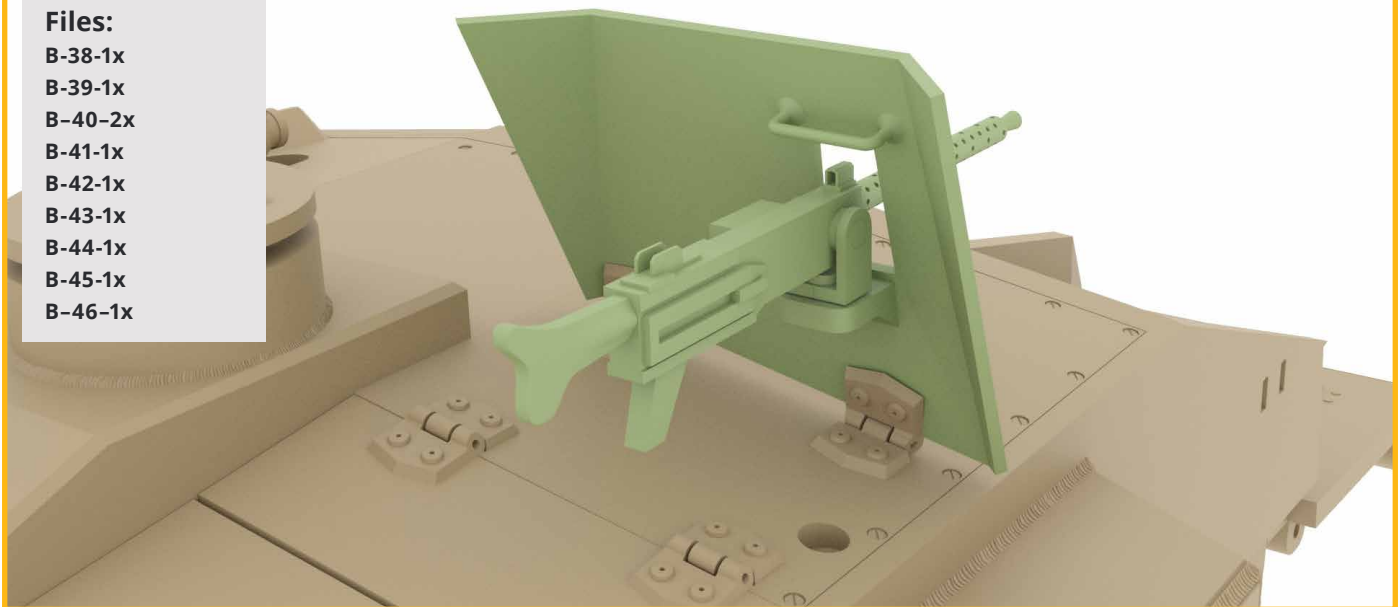

D

Files:

D-1-right-1x
D-1-left-1x
D-2-right-1x
D-2-left-1x
D-3-right-1x
D-3-left-1x
D-4-right-1x
D-4-left-1x

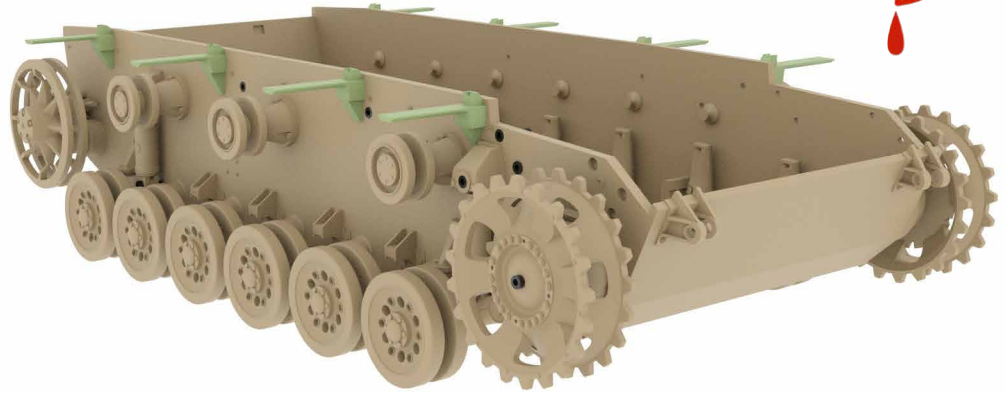

Files:

D-5-right-1x
D-5-left-1x
D-6-right-1x
D-6-left-1x
D-7-right-1x
D-7-left-1x
D-8-right-1x
D-8-left-1x
D-9-right-1x
D-9-left-1x

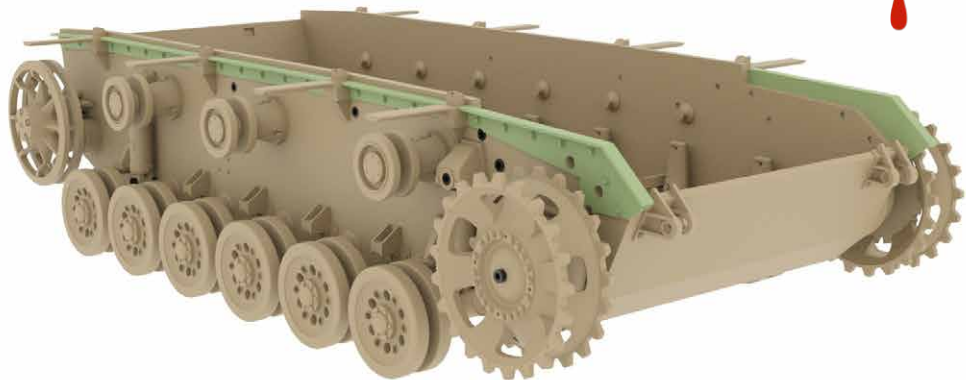

Files:

D-10-right-1x
D-10-left-1x
D-11-right-1x
D-11-left-1x
D-12-right-1x
D-12-left-1x

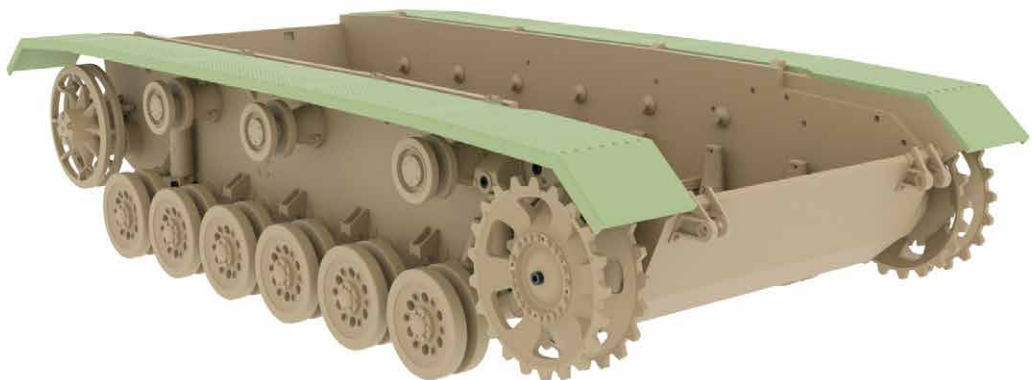

Files:
D-13-4x

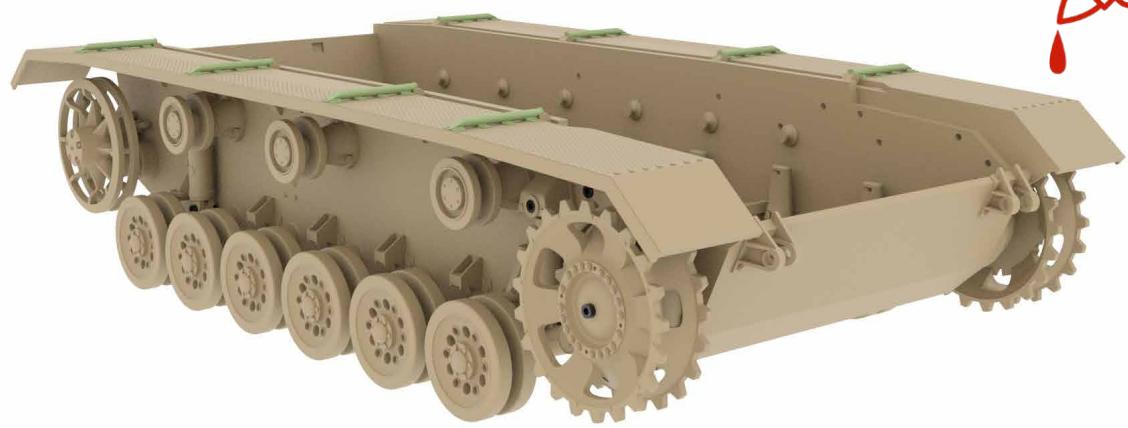

Files:
E-1-1x
E-2-1x

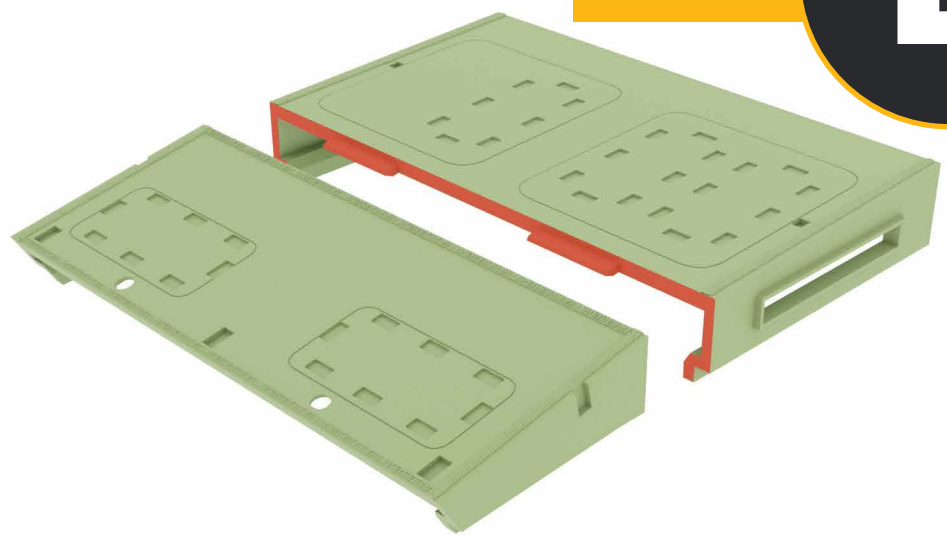

Files:
E-3-5x
E-4-40x

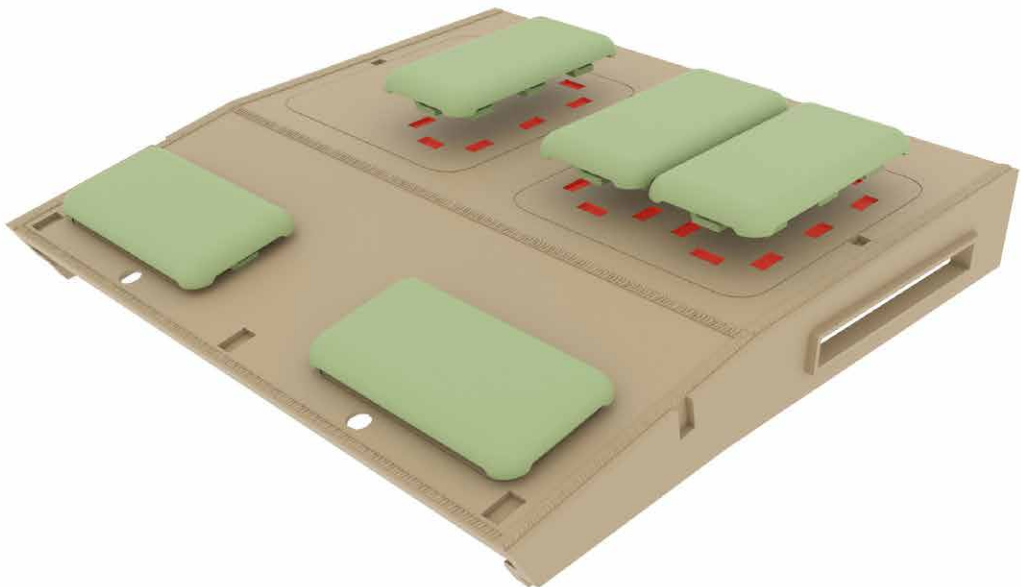
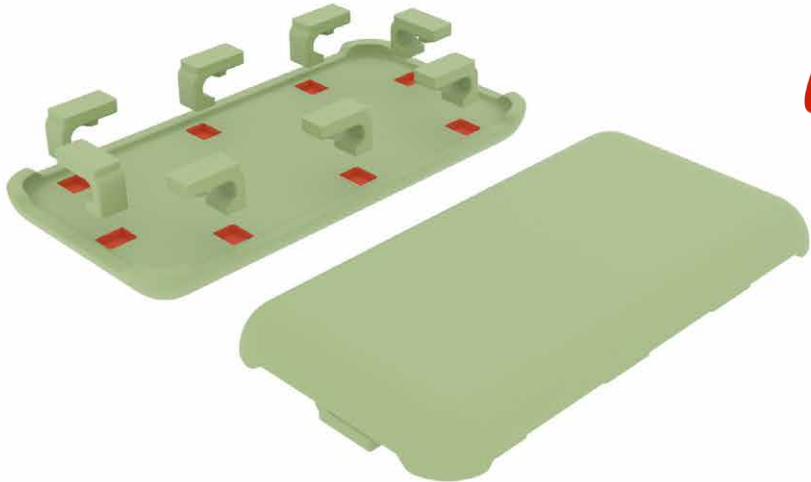

Files:
E-5-right-1x
E-5-left-1x
E-6-2x
E-7-right-1x
E-7-left-1x

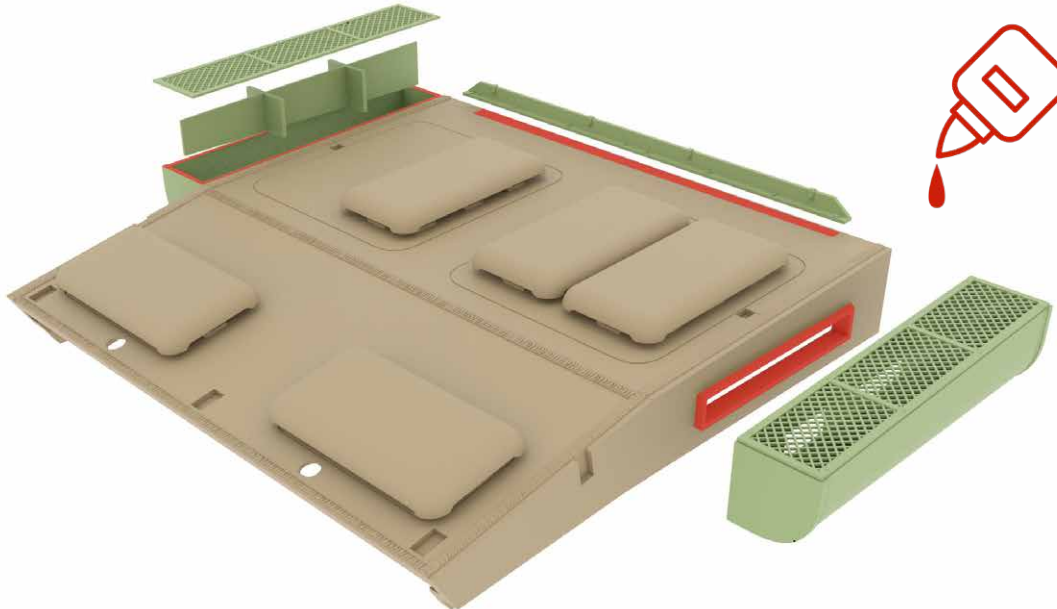

Files:
E-7-2x



Files:
E-8-2x
E-9-1x
E-10-1x

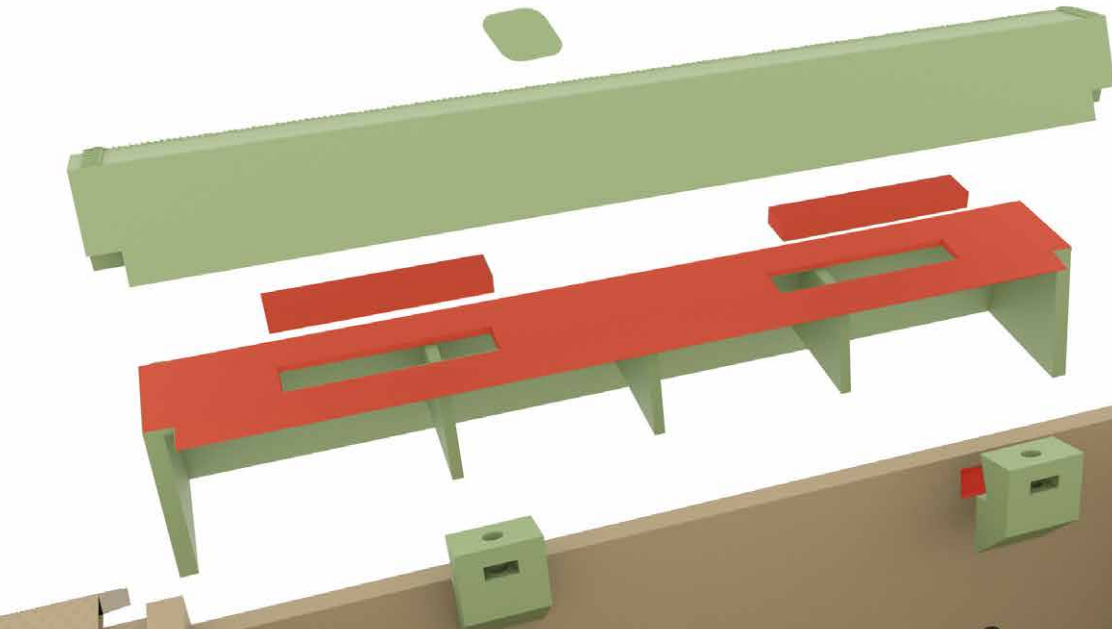

F

Files:

F-1-1x
F-2-1x
F-3-1x
F-4-1x
F-5-1x
F-6-1x
F-7-1x
F-8-1x

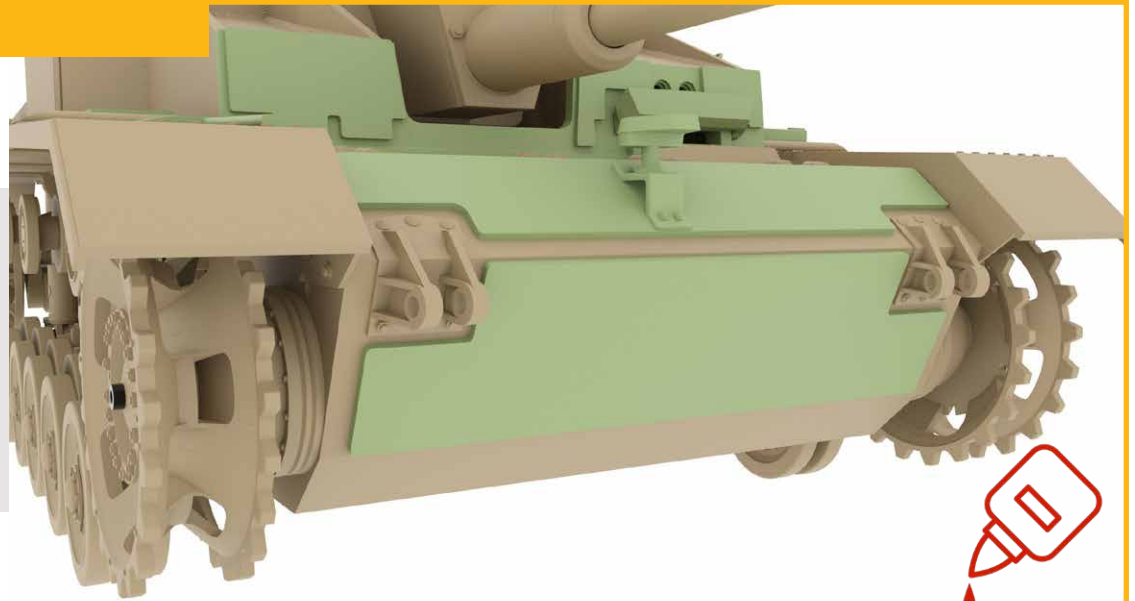

Files:

F-9-1x
F-10-right-1x
F-10-left-1x
F-11-1x
F-12-1x
F-13-1x
F-14-1x
F-15-1x
F-16-2x
F-17-1x
F-18-1x
F-19-2x
F-20-right-1x
F-20-left-1x



Files:

F-21-right-1x
F-21-left-1x
F-22-right-1x
F-22-left-1x
F-23-2x
F-24-2x
F-25-2x
F-26-2x
F-27-2x
F-28-2x
F-29-FLEX-4x
F-30-1x
F-31-1x





Files:
G-1-188x
G-2-188x

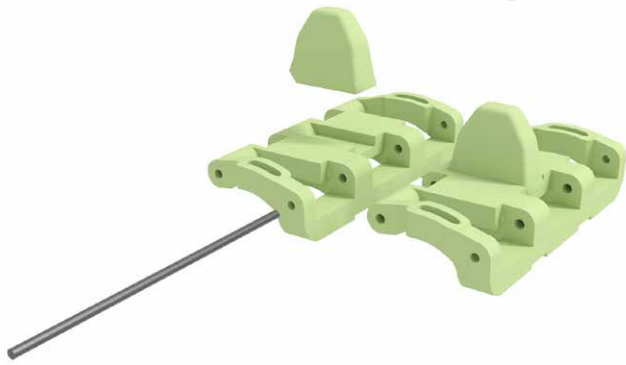

Files:
G-3-right-94x
G-3-left-94x
G-2-188x





autor: **Petr Školař**
web: **www.3dtiks.store**
e-mail: **3dtisk@gpstudio.cz**