

VERSION 1.2.

2024



Sturmgeschutz III

StuG III Ausf.
1:10



UPDATE – V-1.2.



BUILD GUIDE

www.3dtisk.store

Build Guide

3d print

Settings :

Print setting: 0.20mm (for connecting parts 0.15mm more accurate, e.g. inserting ball bearings)

Filling: 15% (for moving parts 100%, e.g. gearbox)

Filament: **PLA 3 Kg**

STL files: **260 pcs**

Print duration: **9 days**

UPDATE V-1.2.

combined gearbox, stronger drive axle, easier assembly, replaceable parts, new belt tensioner

Spojovací materiál

Screws

M3 x 16mm = 66pcs

M3 x 10mm = 8pcs

Ball-bearing:

Ball-bearing 10 x 15 x 4mm = 20pcs

Ball-bearing 12 x 21 x 5mm = 4pcs

XL Timing belt

70, teeth: 35 = 4pcs

Springs:

0,5 mm, 30 mm, 5 mm = 12pcs

Binding wire: tl. 1 mm

Super glue

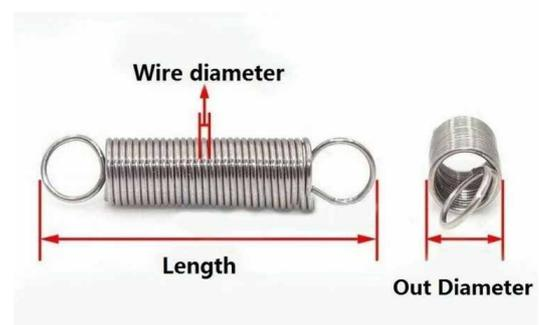

Engines:

DC motors 540

Dimensions (\varnothing x d) 35.8 mm x 50 mm

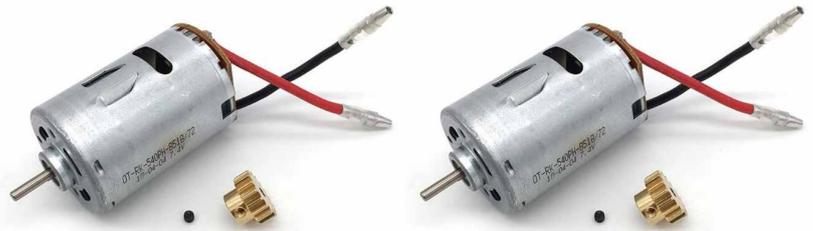

Regulators:

bidirectional electric speed controller, for DC motors.

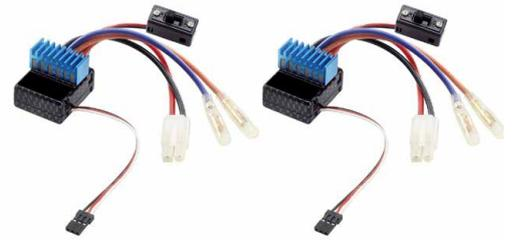

Serve:

20,3 x 38x 40,5mm



CONTROL WIRING DIAGRAM

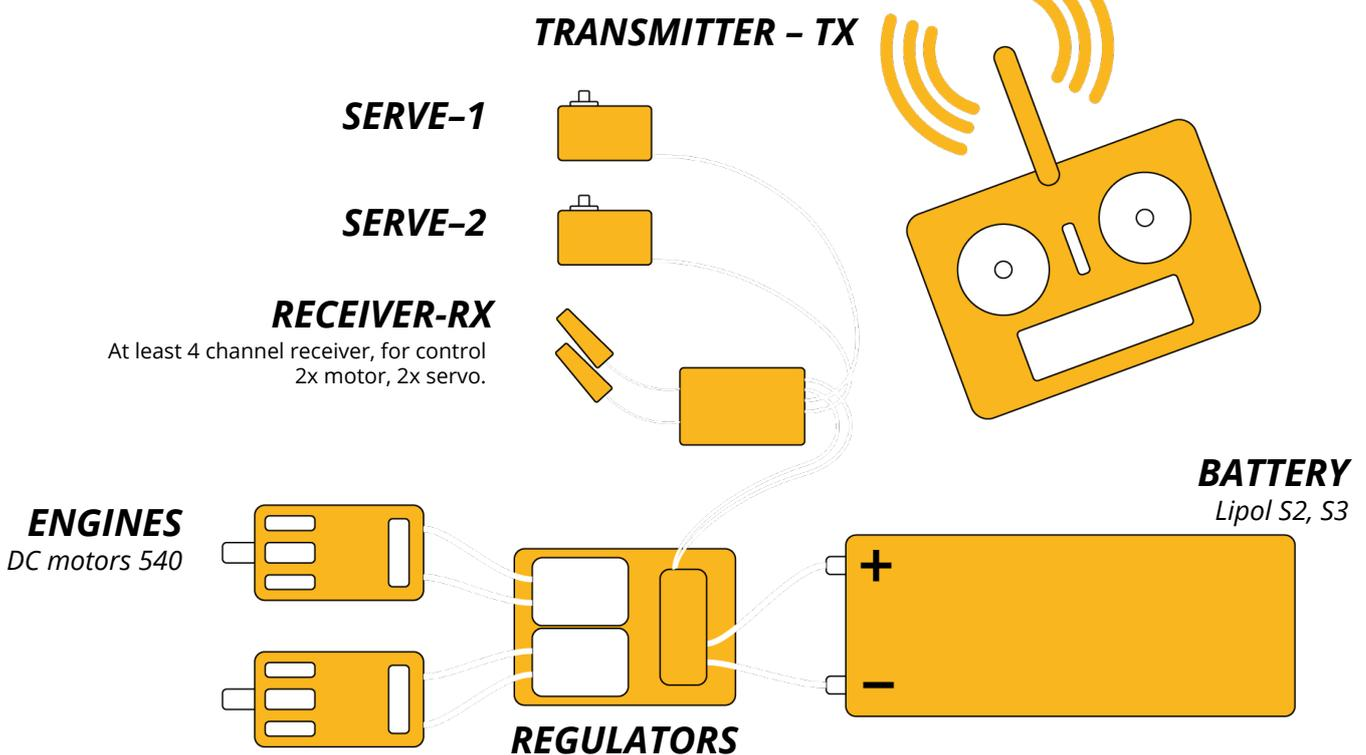

Sturmgeschütz III

StuG III Ausf. A

MODEL PARAMETERS

Scale: 1:10

Dimension: 753 x 325 x 260 mm

Weight: 4,5 Kg

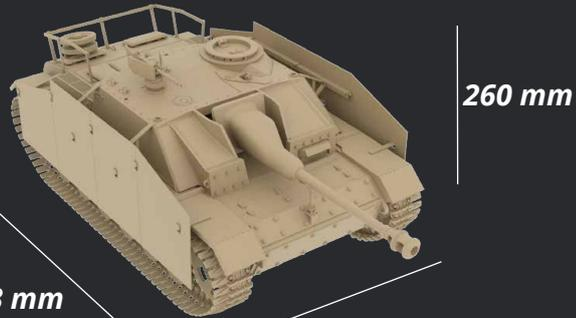

A

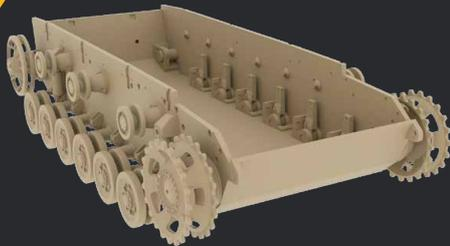

E



B



F

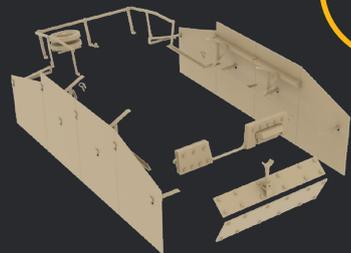

C



G

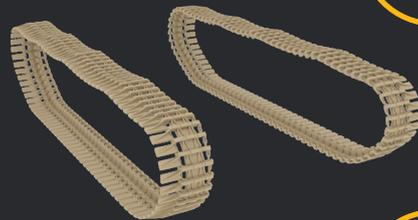

D



P



StuG III

A

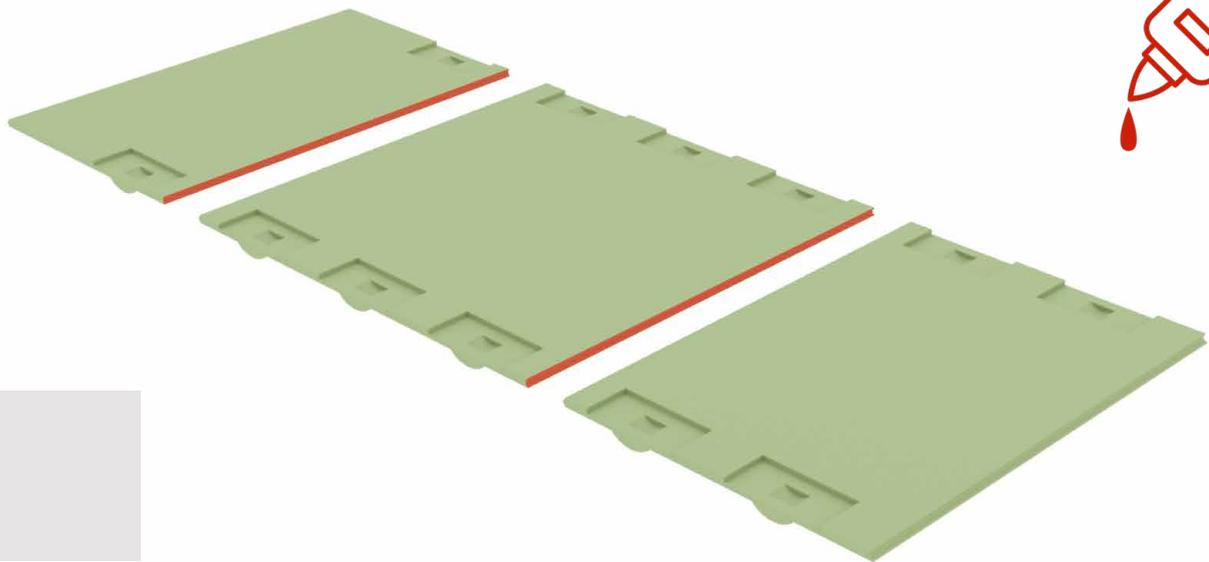
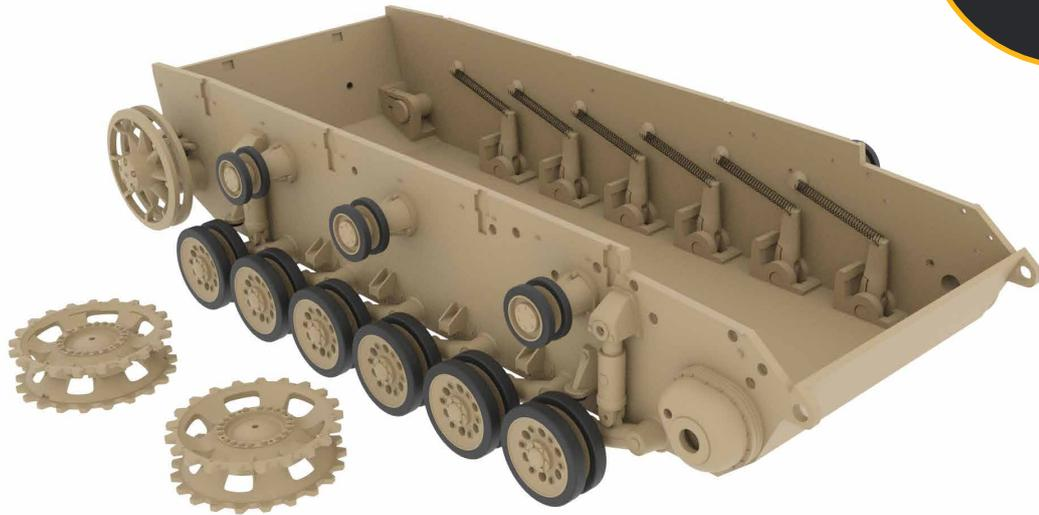

Files:

- A-1-1x
- A-2-1x
- A-3-1x

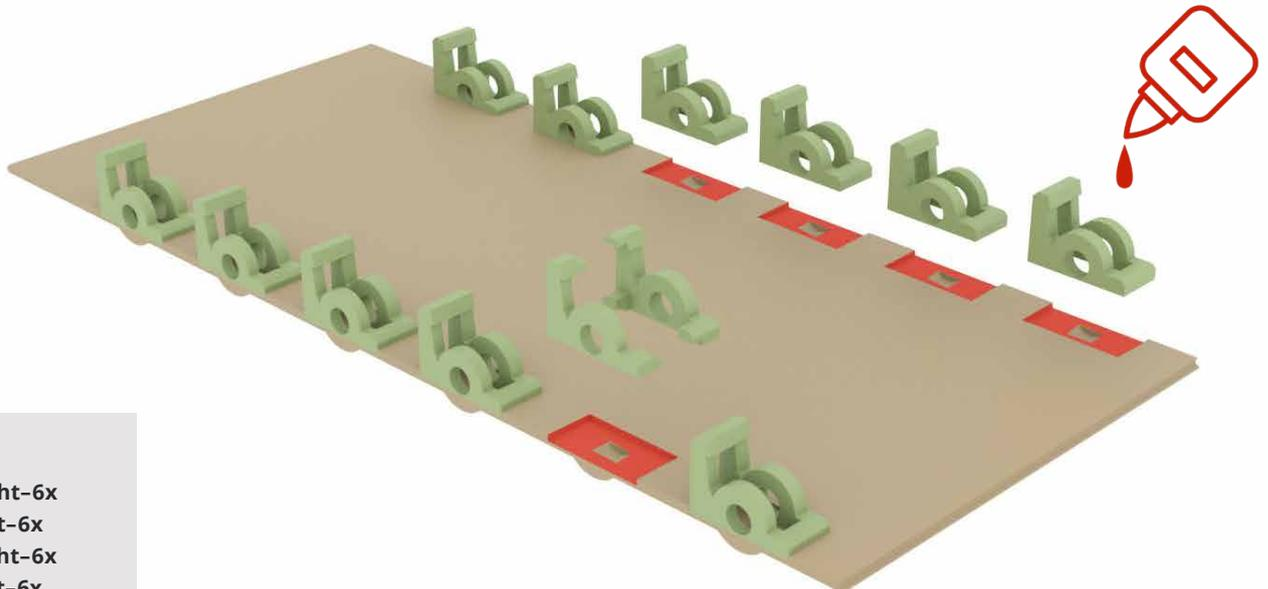

Files:

- A-4-right-6x
- A-4-left-6x
- A-5-right-6x
- A-5-left-6x

Files:

- A-6-right-1x
- A-6-left-1x
- A-7-right-1x
- A-7-left-1x
- A-8-right-1x
- A-8-left-1x

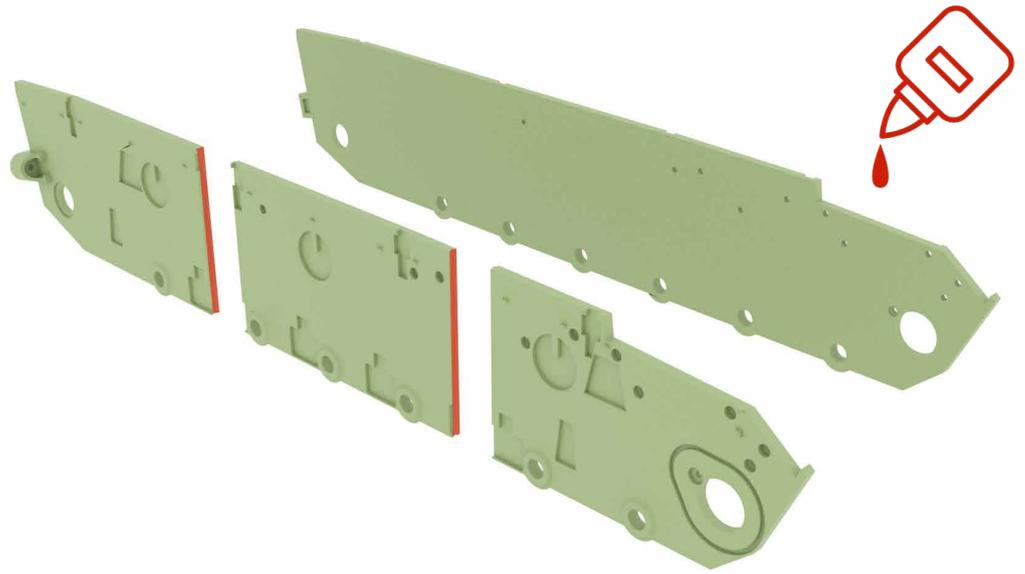

Files:

- A-11-1x
- A-12-right-1x
- A-12-left-1x

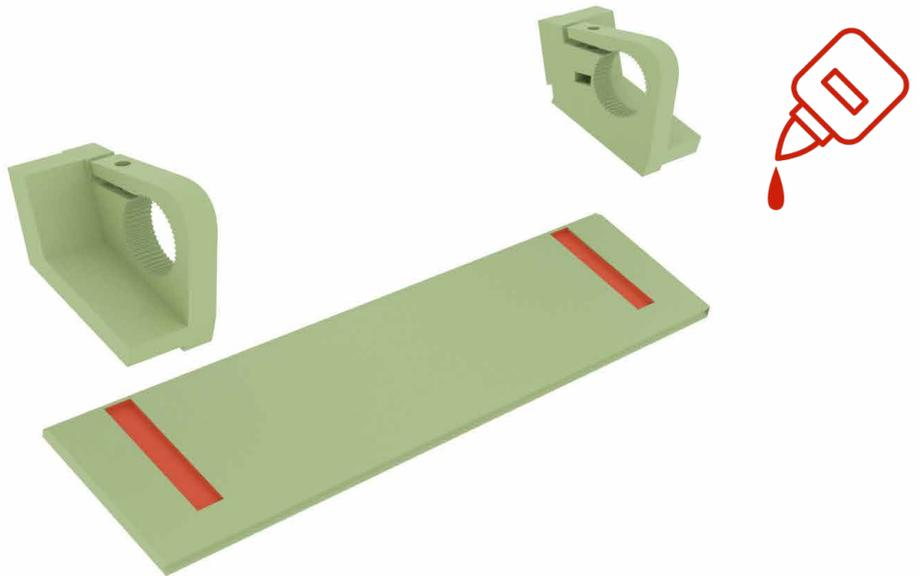

Files:

- A-9-1x
- A-10-1x
- A-11-1x
- A-12-right-1x
- A-12-left-1x
- A-13-1x

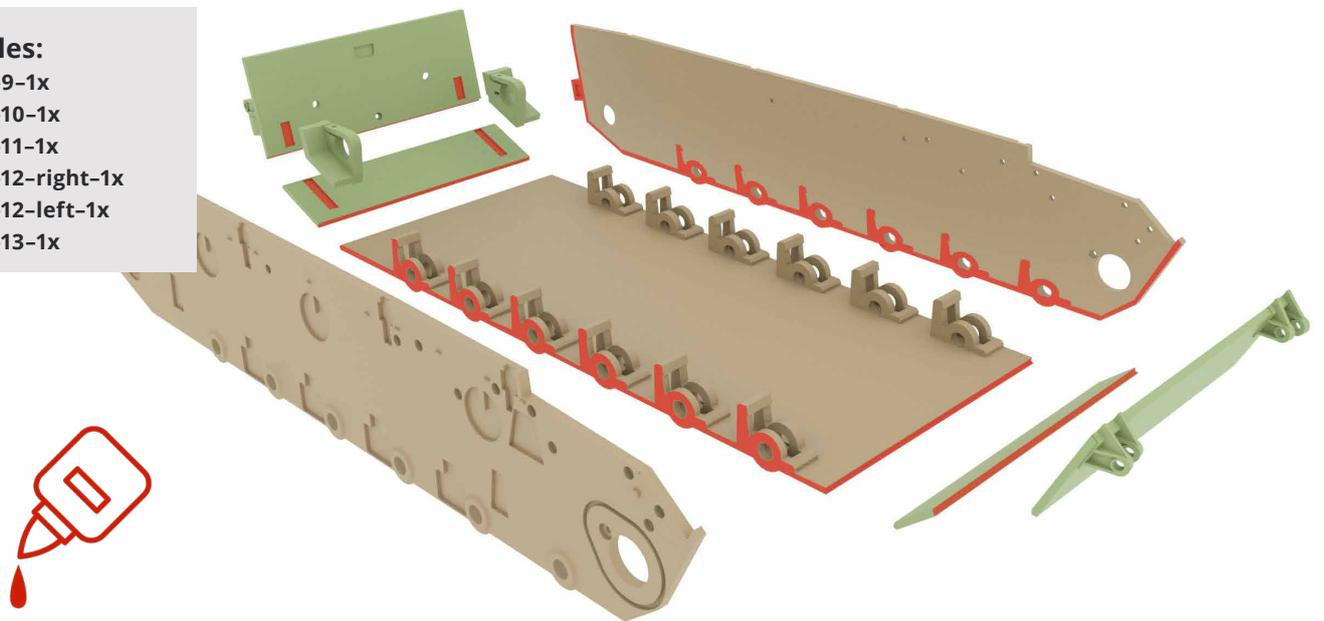

Files:
A-14-4x
A-15-FLEX-4x

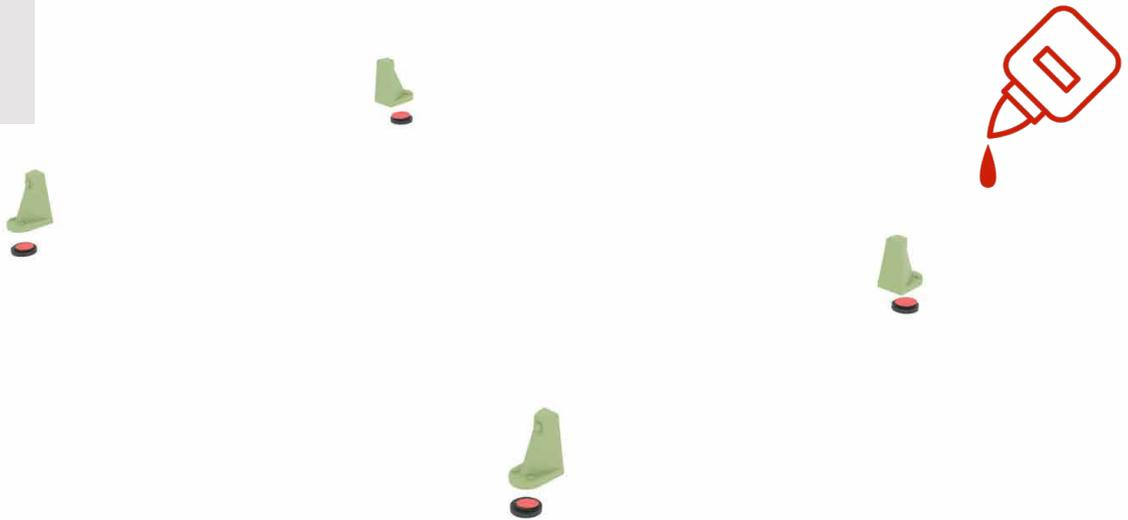

Files:
A-14-4x
A-15-FLEX-4x
A-16-8x
A-17-6x
A-18-4x
A-19-1-right-1x
A-19-1-left-1x
A-20-2x

M3 16mm 2x
Bearings-
12x21x5mm-2x

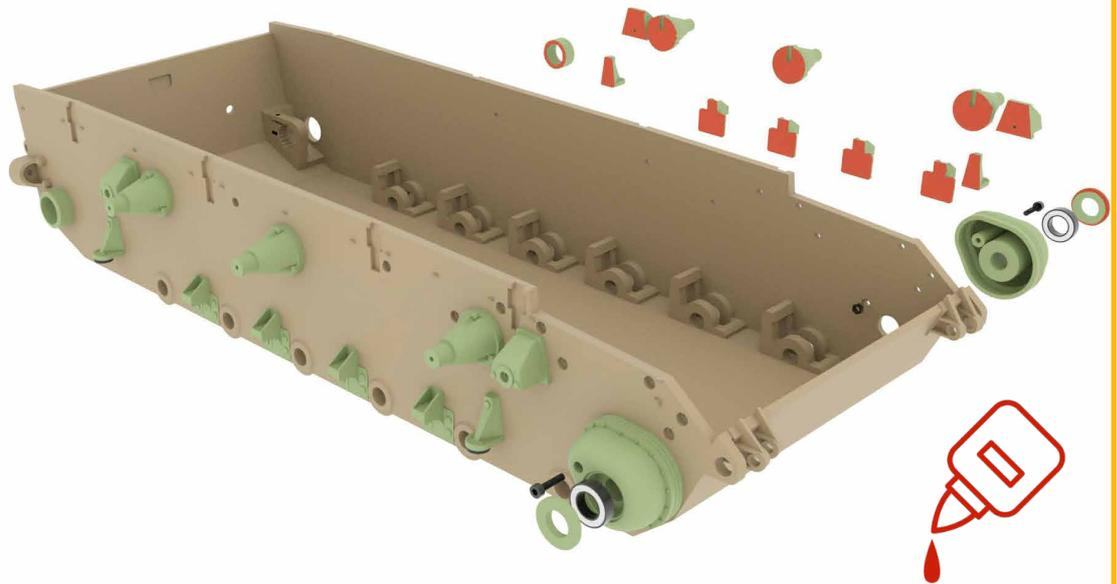

Files:
A-21-6x
A-22-6x
A-23-6x
A-24-6x
A-24-FLEX-12x

M3 16mm 6x

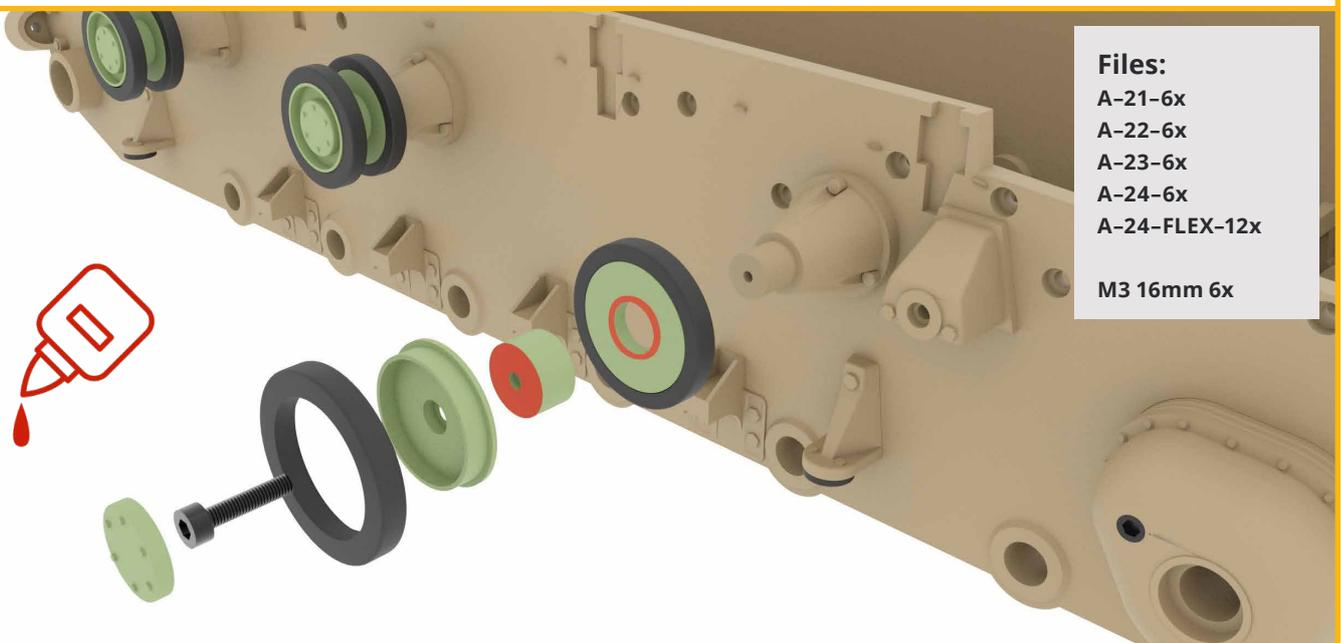

Files:

- A-25-12x
- A-26-12x
- A-27-12x
- A-28-12x
- A-29-FLEX-24x

Bearings-
10x15x4mm-12x

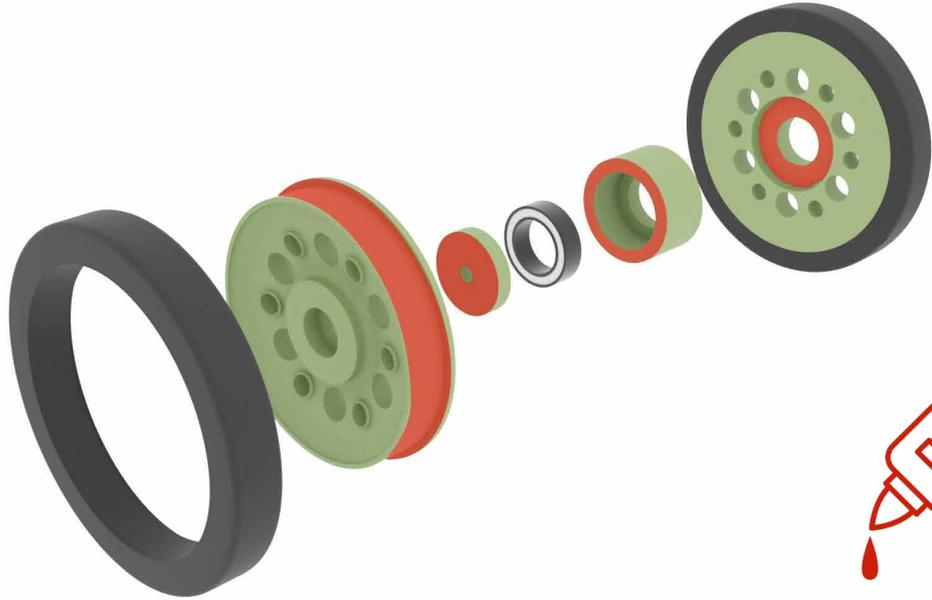

Files:

- A-30-12x
- A-31-right-2x
- A-31-left-2x
- A-32-12x
- A-32-right-4x
- A-32-left-4x

M3 16mm 12x



Files:

- A-33-4x
- A-34-4x

M3 10mm 8x



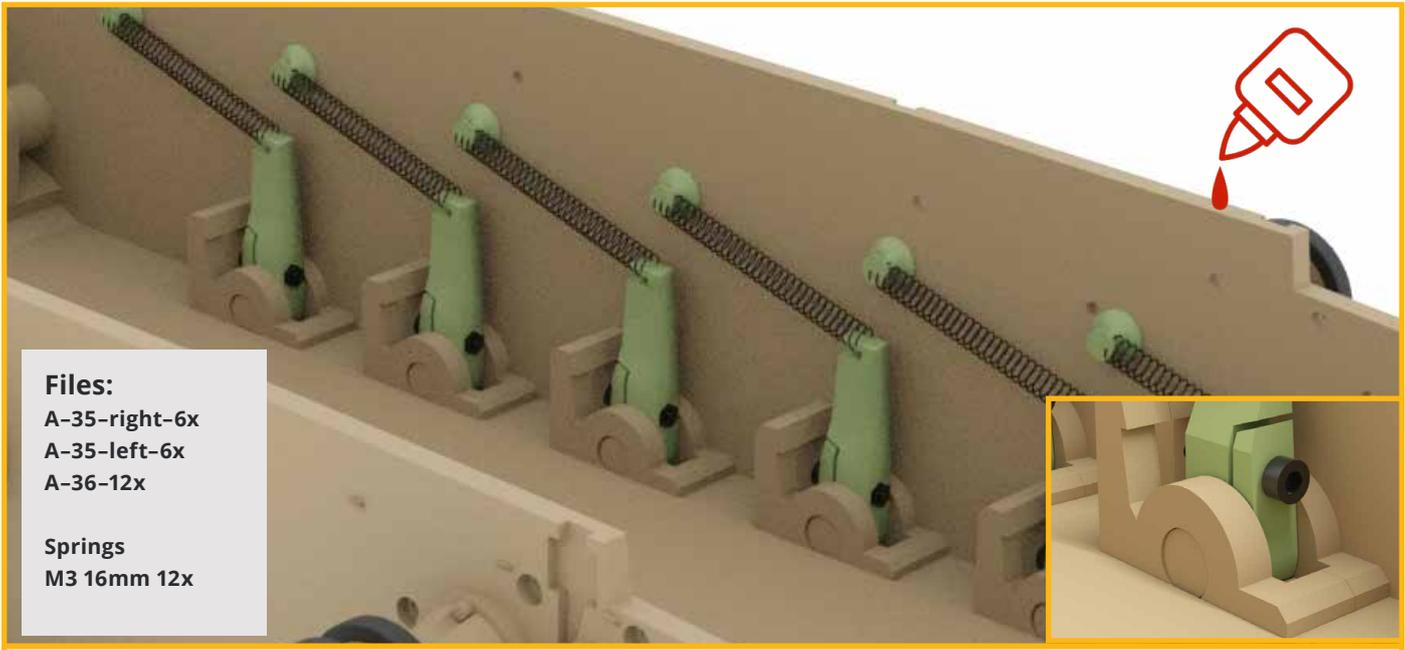

Files:
A-35-right-6x
A-35-left-6x
A-36-12x

Springs
M3 16mm 12x

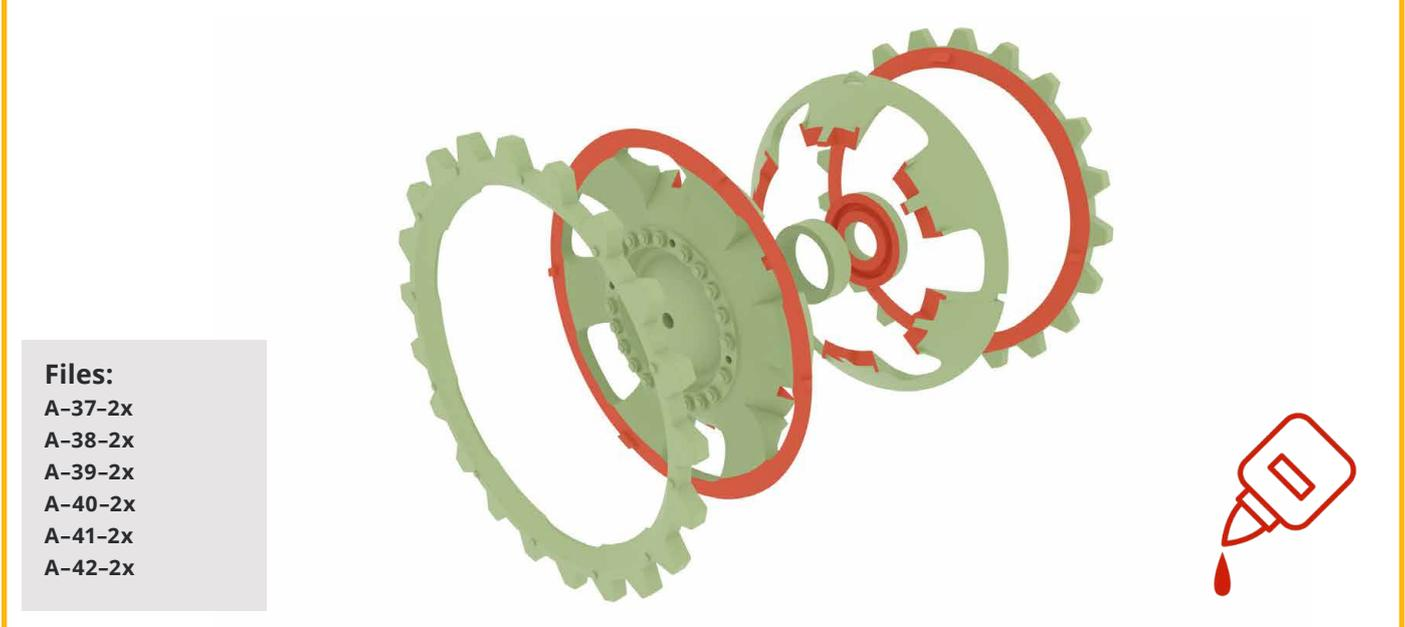

Files:
A-37-2x
A-38-2x
A-39-2x
A-40-2x
A-41-2x
A-42-2x

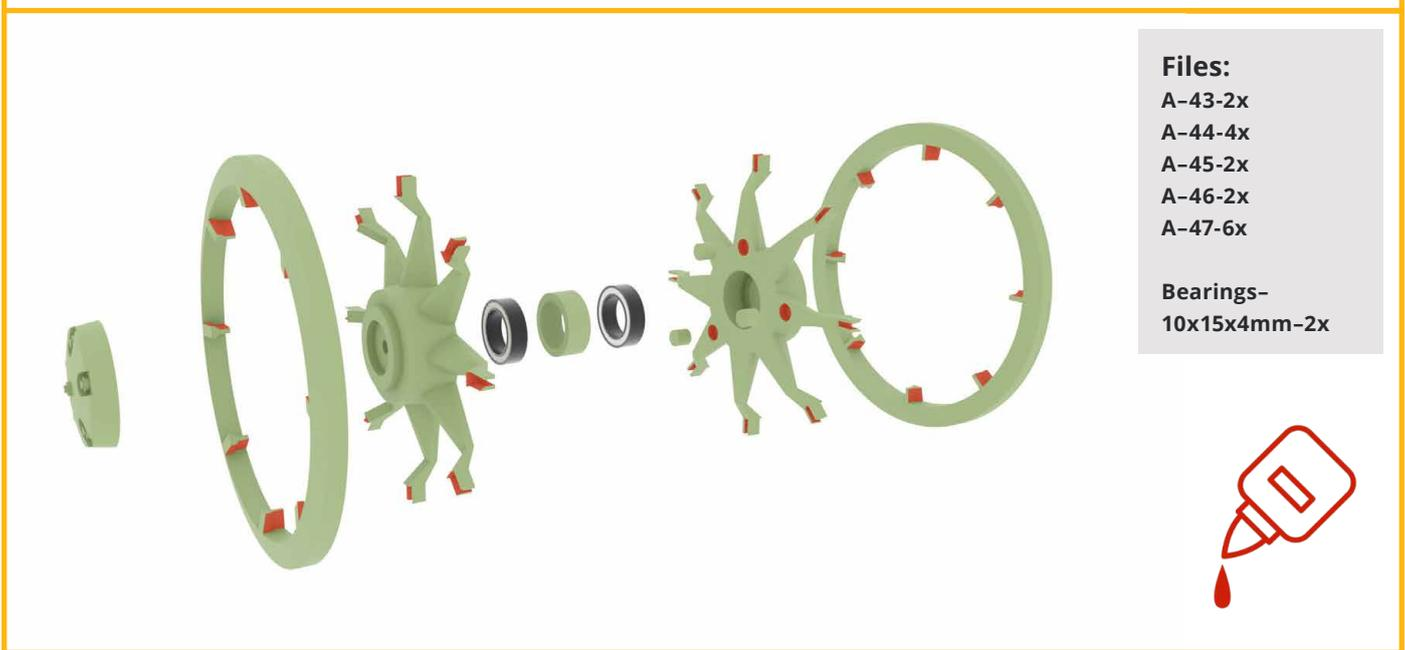

Files:
A-43-2x
A-44-4x
A-45-2x
A-46-2x
A-47-6x

Bearings-
10x15x4mm-2x

Files:

- A-49-2x
- A-50-right-1x
- A-50-left-1x
- A-51-2x
- A-52-2x

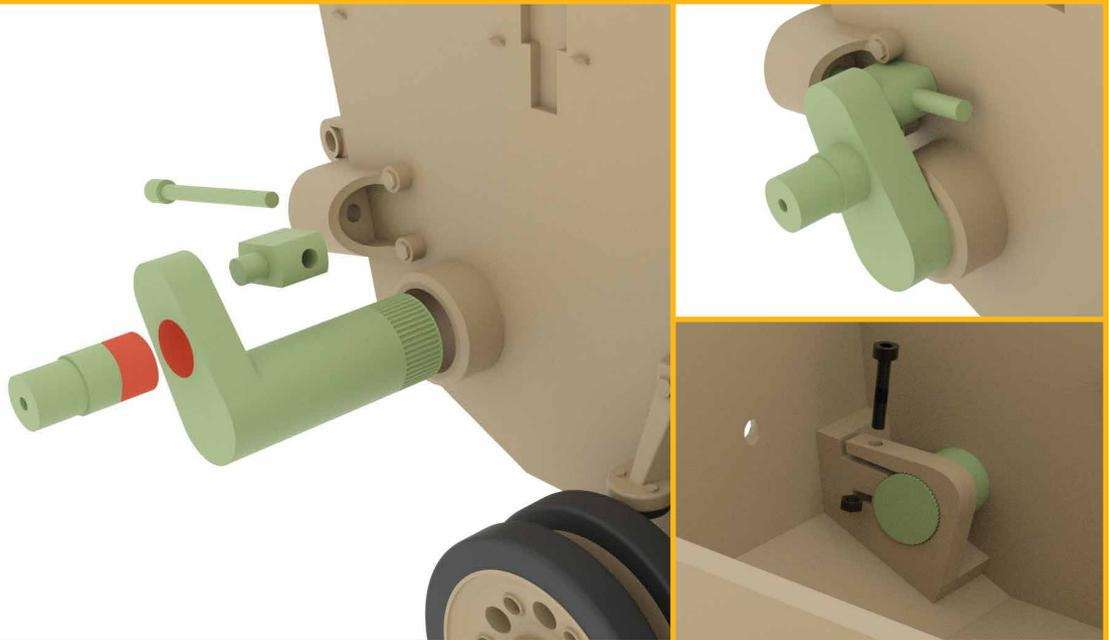

Files:

- M3 16mm 2x

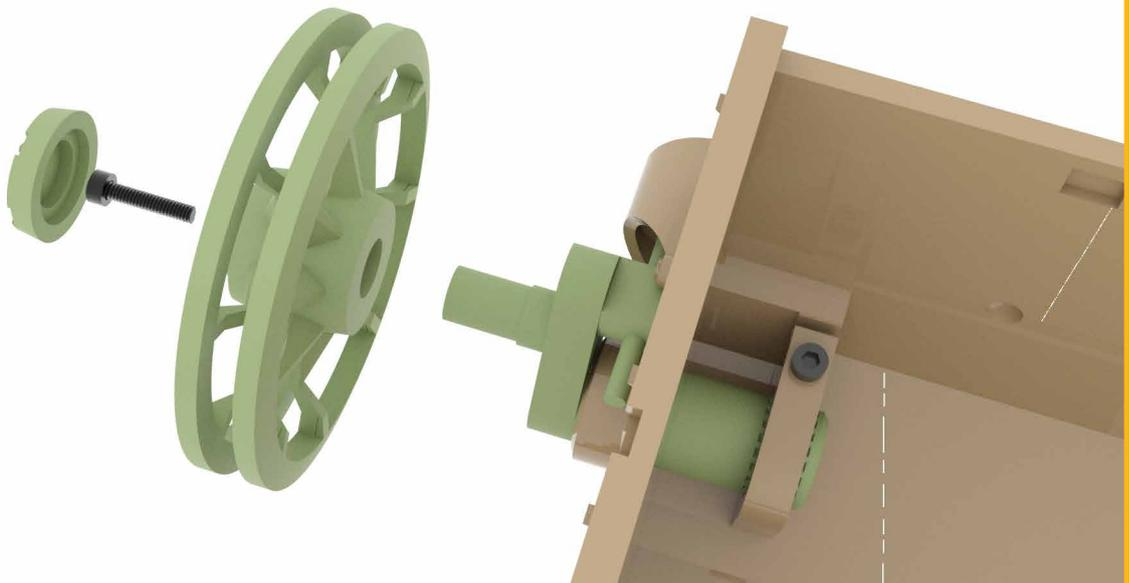

Files:

- A-53-right-1x
- A-53-left-1x
- A-54-right-1x
- A-54-left-1x
- A-55-1x
- A-56-1x
- A-57-1x

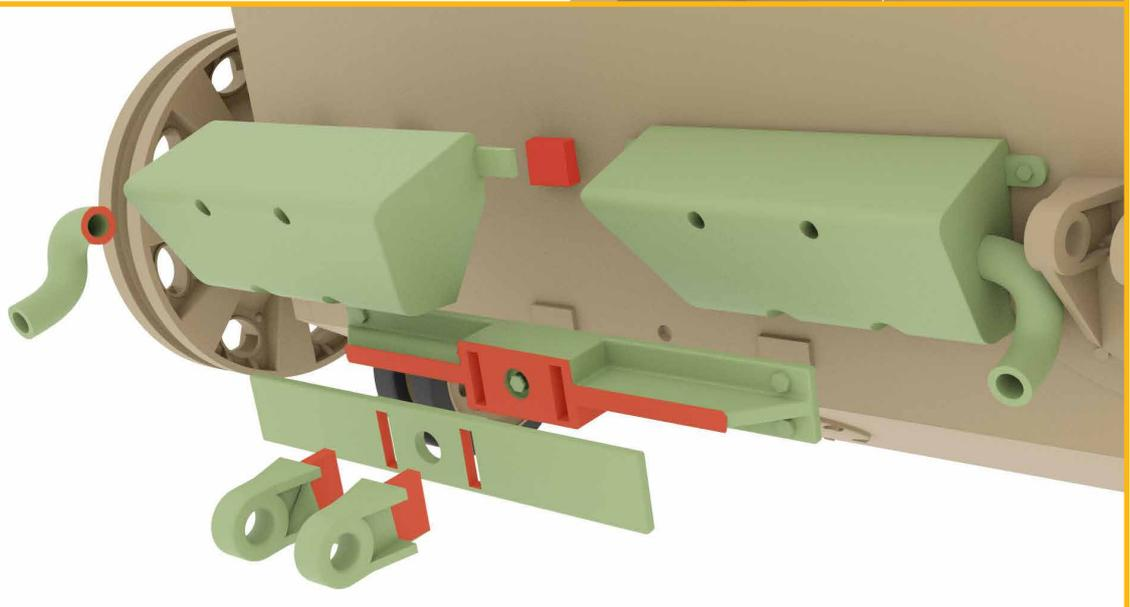

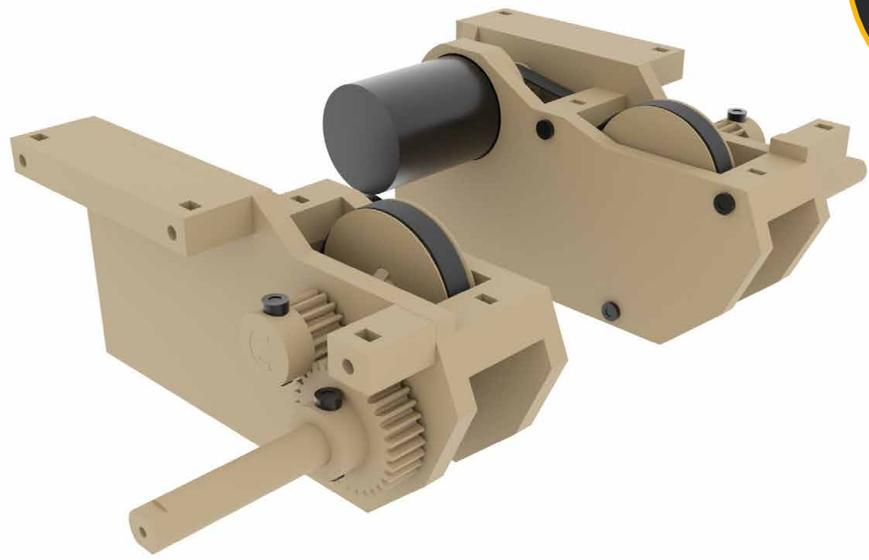

Files:

- P-1-right-1x
- P-1-left-1x
- P-2-right-1x
- P-2-left-1x
- P-3-right-1x
- P-3-left-1x

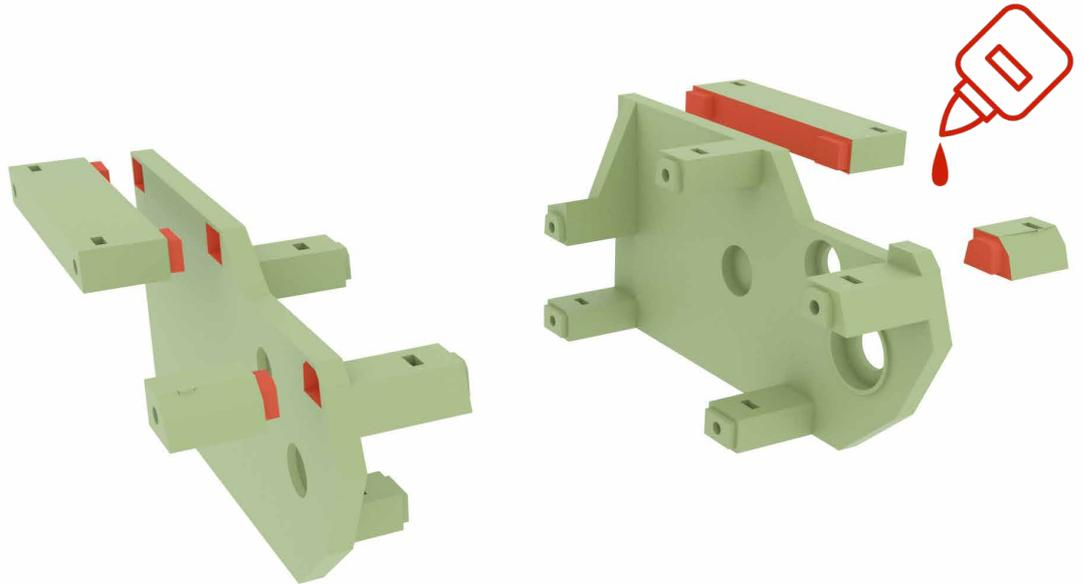

Files:

- P-4-2x
- P-5-2x
- M3 16mm 2x
- Bearings-
12x21x5mm-2x



Files:

- P-6-2x
- P-7-2x
- P-8-2x
- P-9-2x
- P-10-2x

- Bearings-
10x15x4mm-4x
- M3 16mm 2x

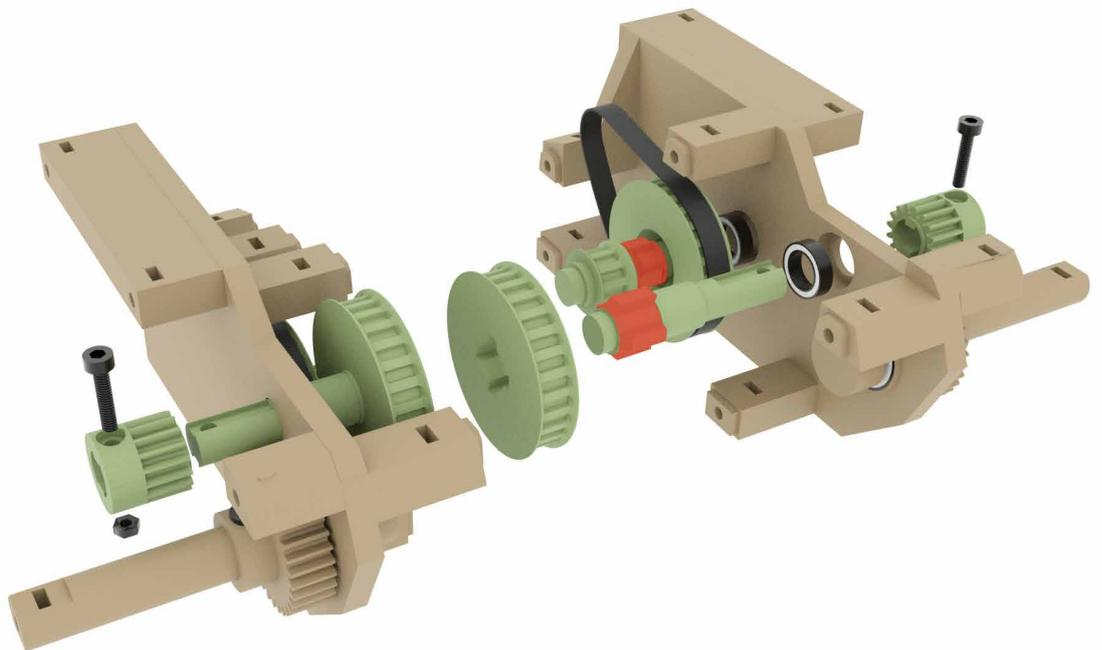

Files:

- P-11-2x
- P-12-right-1x
- P-12-left-1x

- M3 16mm 2x
- Bearings
10x15x4mm-4x

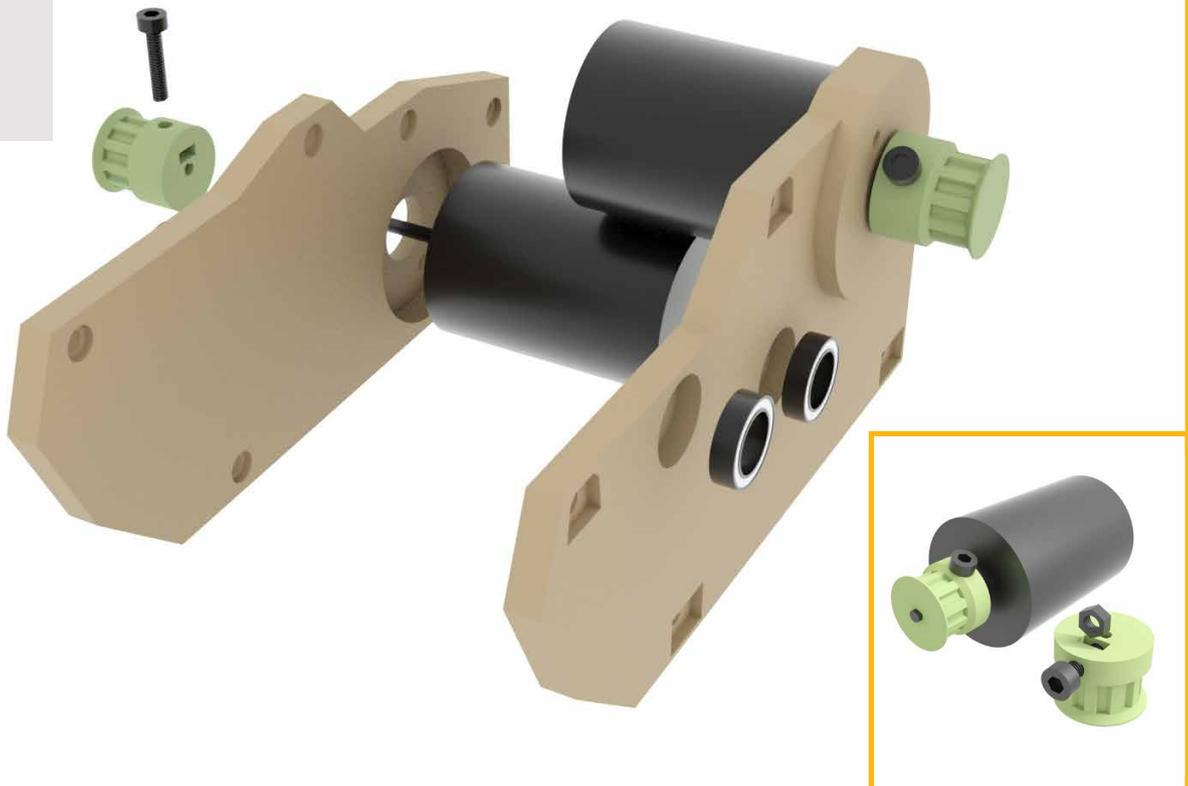



Files:
M3 16mm 12x

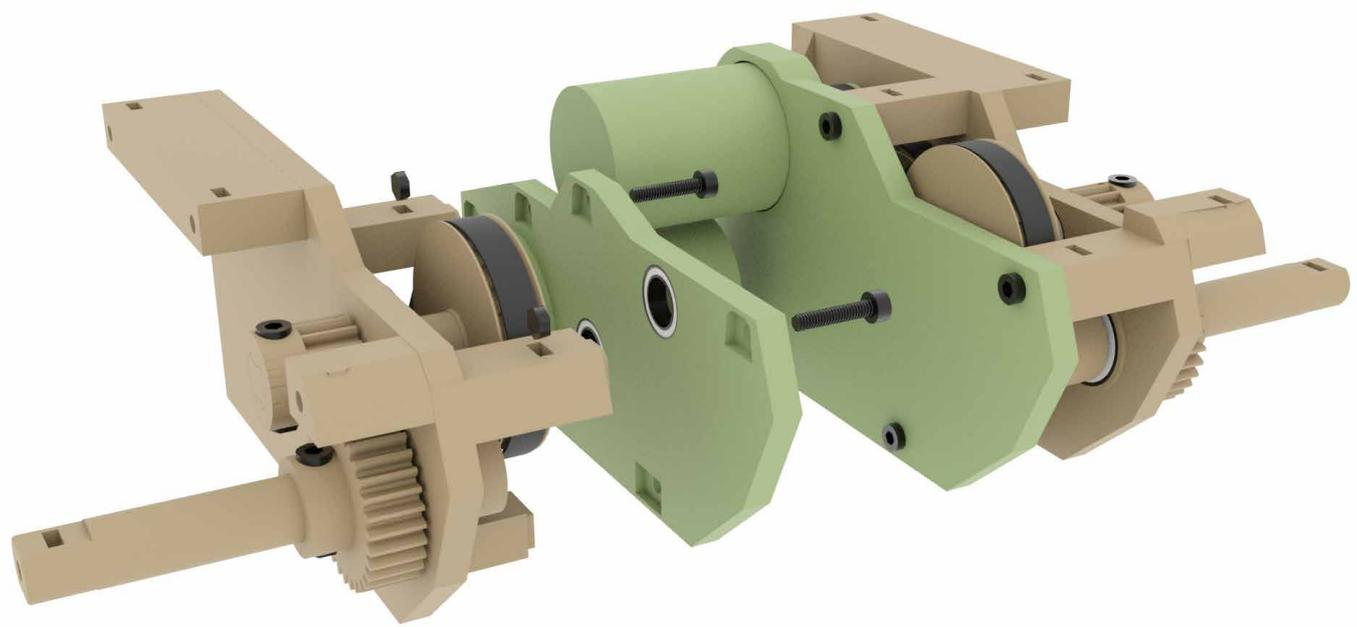

Files:
M3 16mm 2x

B



Files:

B-1-1x

B-3-right-5x

B-3-left-5x

Files:

B-2-1x

B-3-right-5x

B-3-left-5x

B-4-right-1x

B-4-left-1x

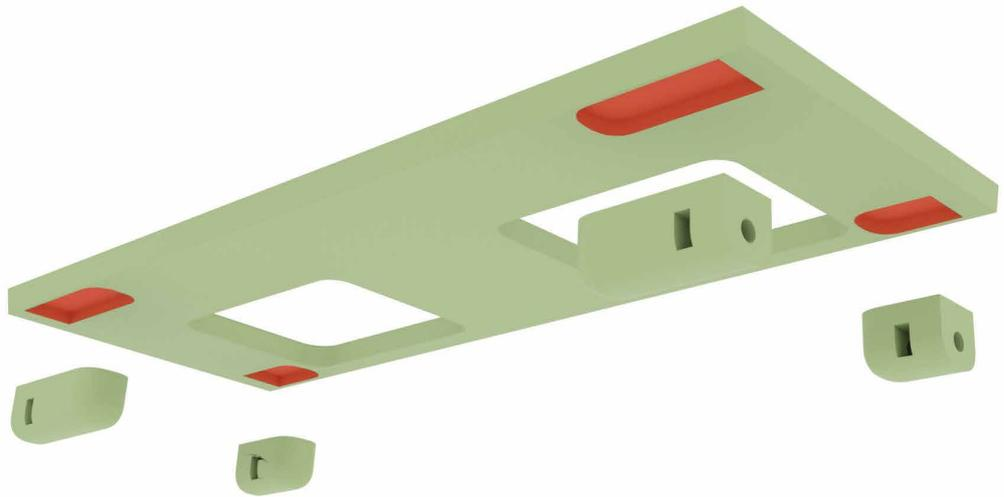

Files:

B-2-1x

B-5-right-2x

B-5-left-2x

B-6-right-4x

B-6-left-4x

B-7-1x

Binding wire 1mm

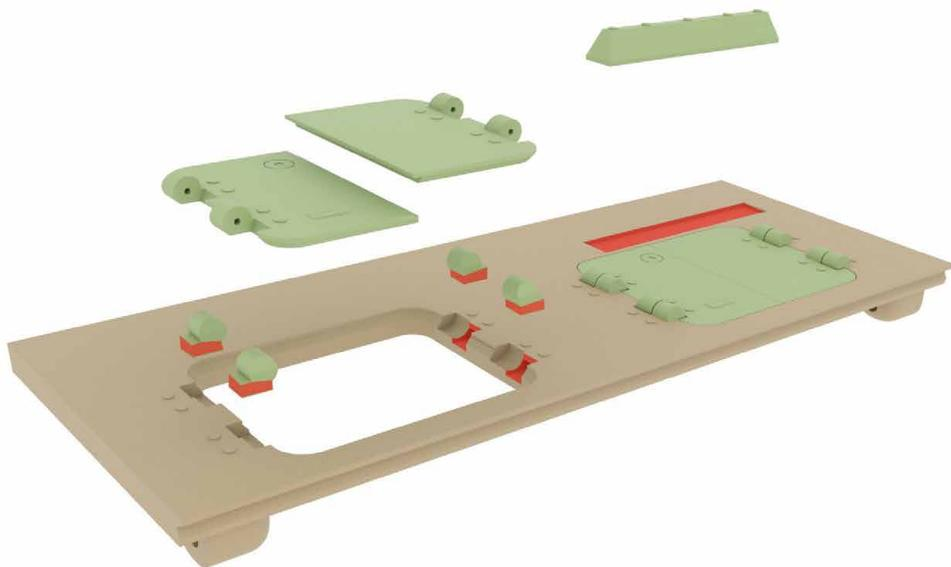

Files:

- B-3-left-5x
- B-8-1x
- B-9-2-1x
- B-9-1-right-1x
- B-9-1-left-1x

Binding wire 1mm

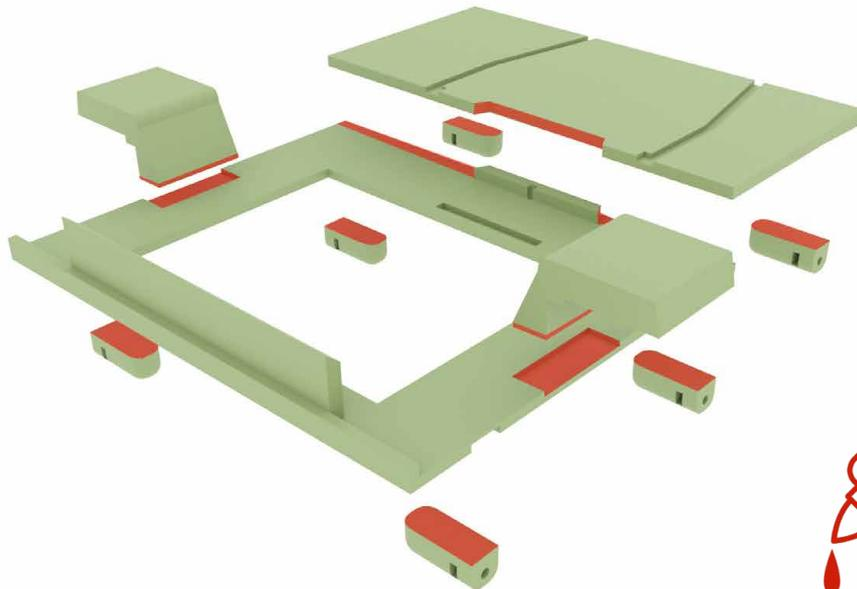

Files:

- B-10-1x
- B-11-1x
- B-12-1x

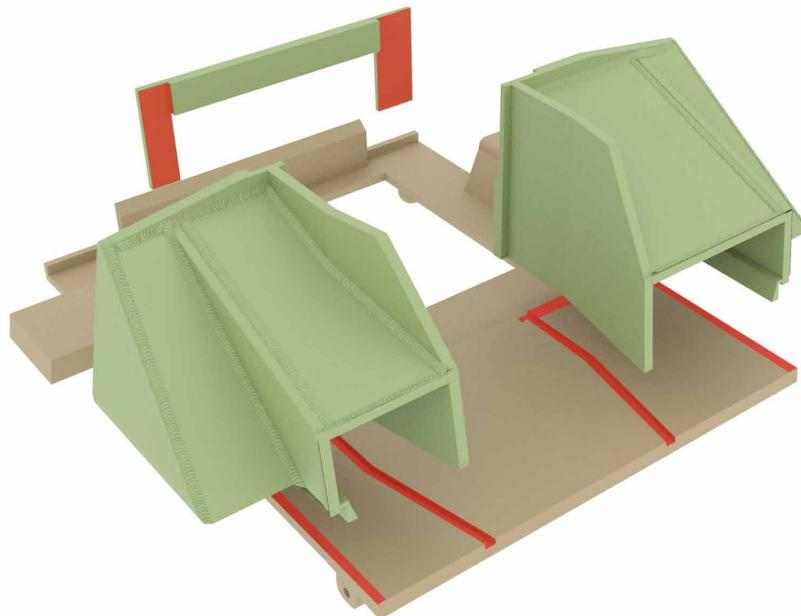

Files:

- B-13-1-right-1x
- B-13-1-left-1x

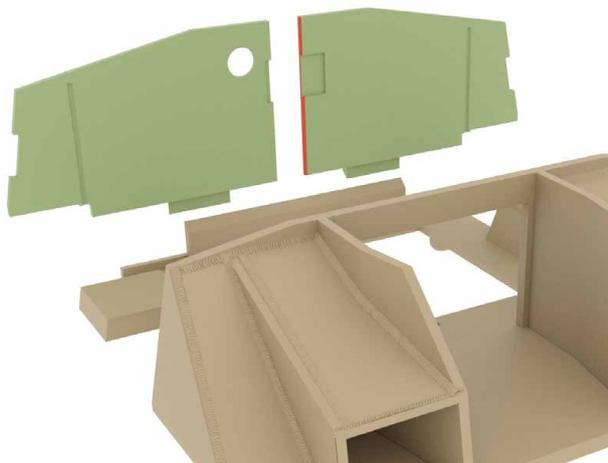

Files:

- B-13-2-right-1x
- B-13-2-left-1x

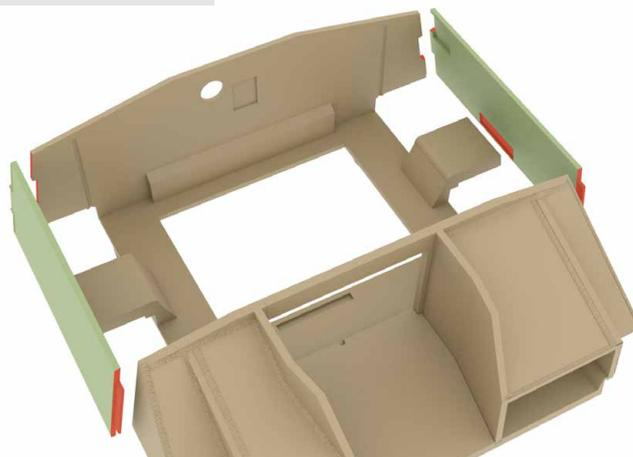



Files:

C-1-1x

C-2-1x

C-3-1x



Files:

C-4-1x

C-5-1x

C-6-1x

C-7-2x

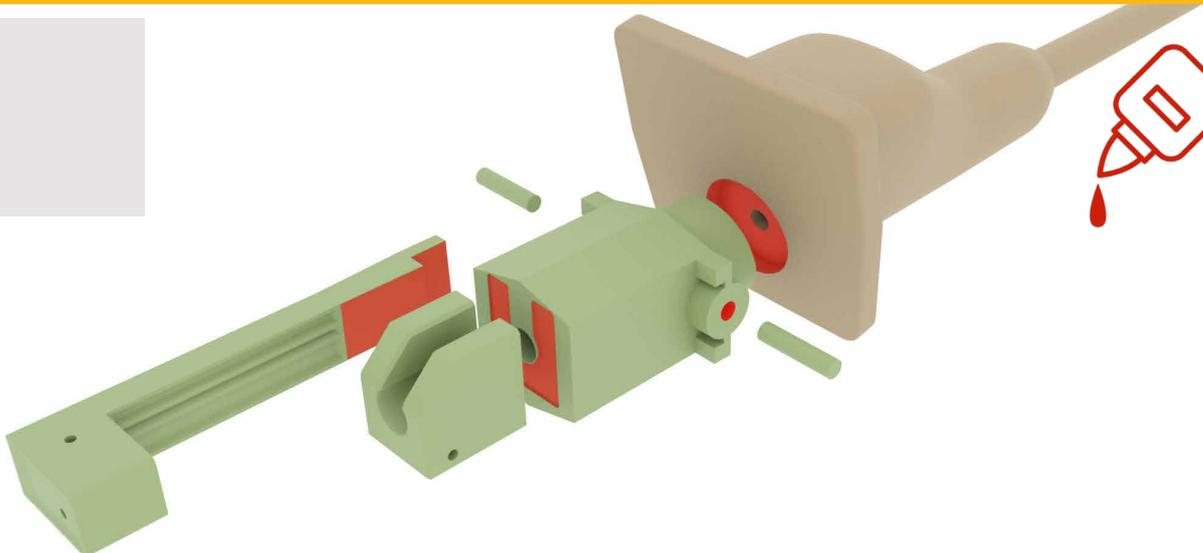

Files:

C-8-right-1x
 C-8-left-1x
 C-9-1x
 C-10-1x
 C-11-1x

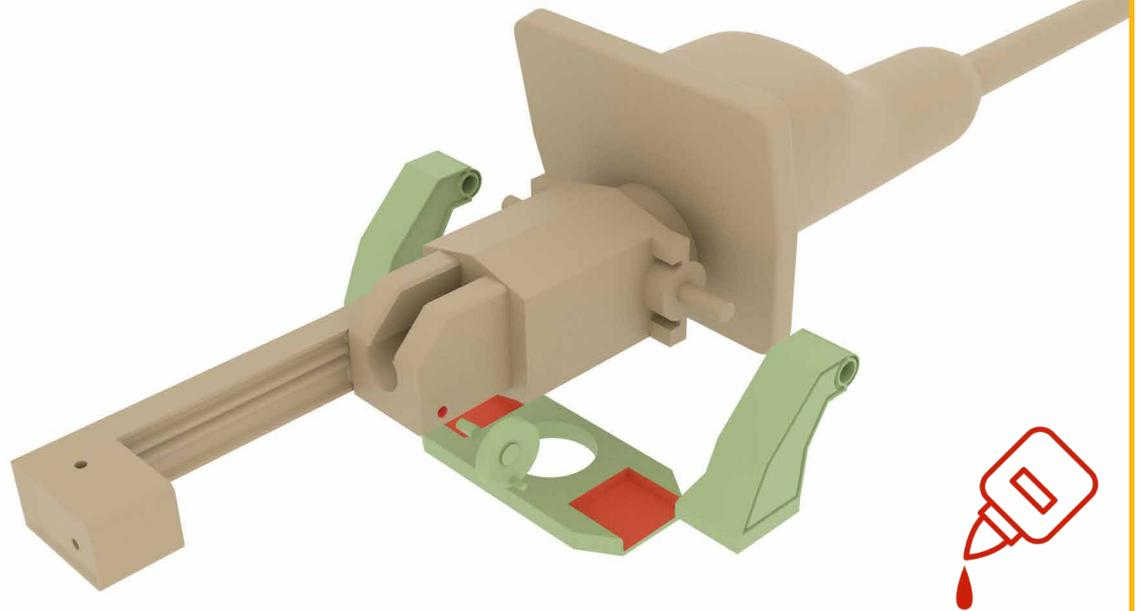
**Files:**

C-12-1x
 C-13-1x
 C-14-1x

M3 16mm 1x

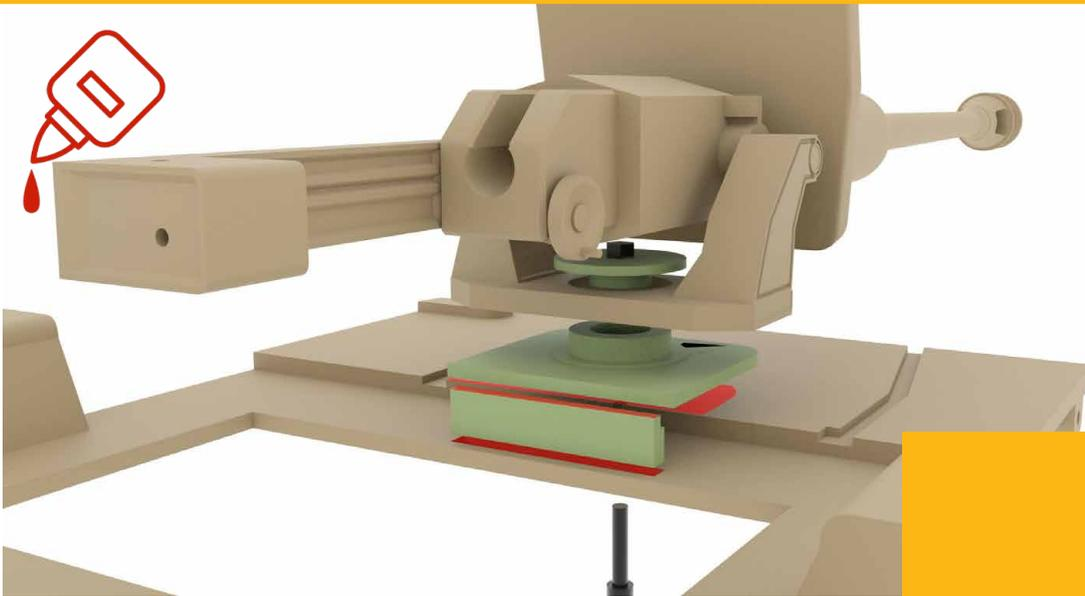
**Files:**

B-24-1x
 B-25-1x
 B-26-1x
 B-27-4x
 B-28-1x
 B-29-1x
 B-30-1x
 B-31-1x

M3 16mm 4x

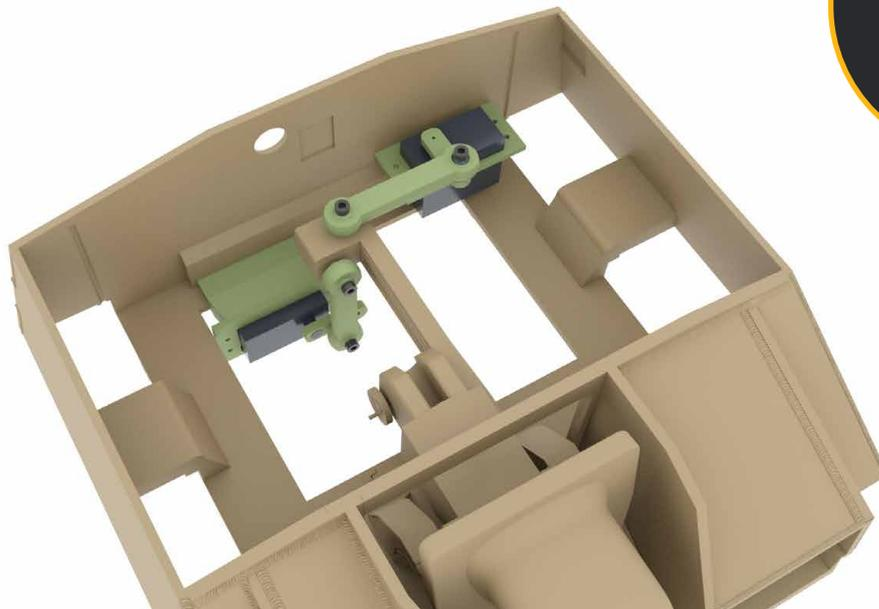

B

Files:

- B-14-1x
- B-15-1x
- B-16-1x
- B-17-1x
- B-18-1x
- B-19-1x
- B-20-2x
- B-21-4x

M3 16mm 4x

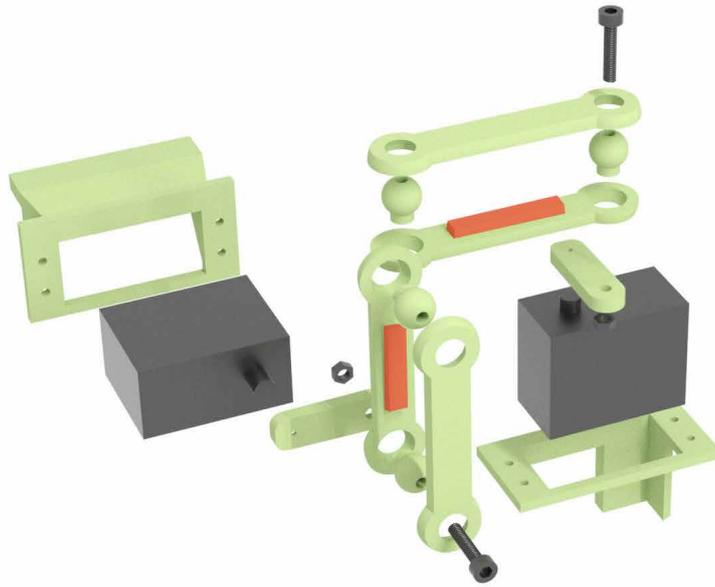

Files:

- B-22-1x
- B-23-1x
- B-24-1x
- B-25-1x
- B-26-1x
- B-27-1x

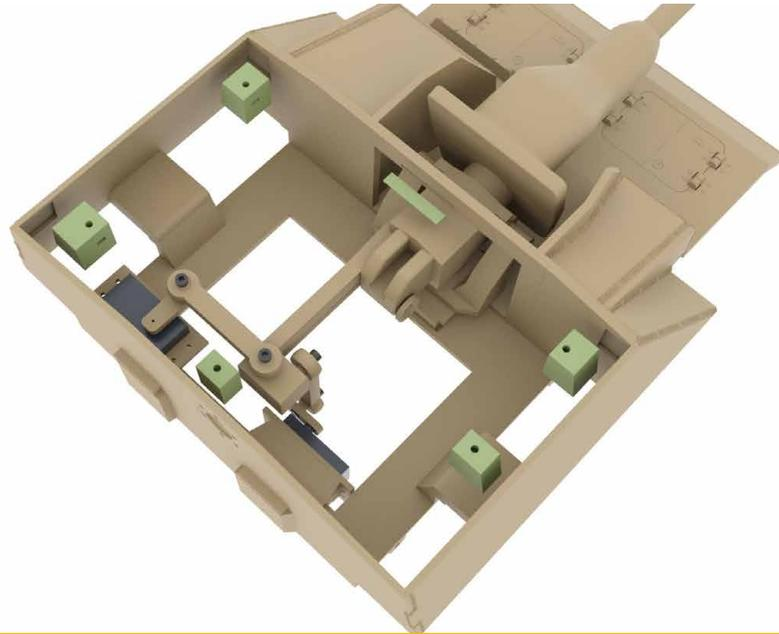

Files:

- B-29-1x
- B-30-1x

M3 16mm 4x

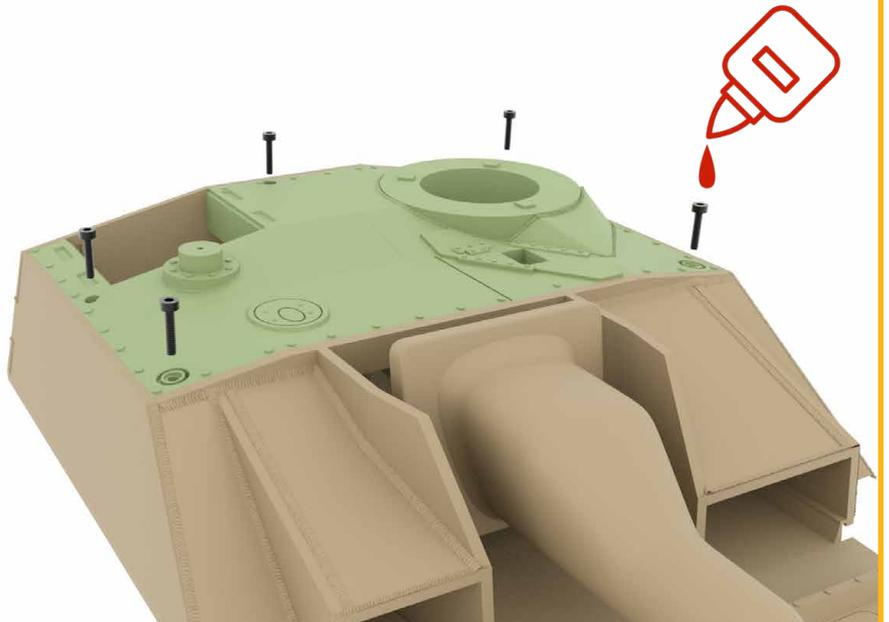

Files:

- B-31-right-1x
- B-31-left-1x
- B-32-4x
- B-33-4x
- B-34-3x
- B-35-1x
- B-36-1x
- B-37-1x
- B-38-1x
- B-39-1x

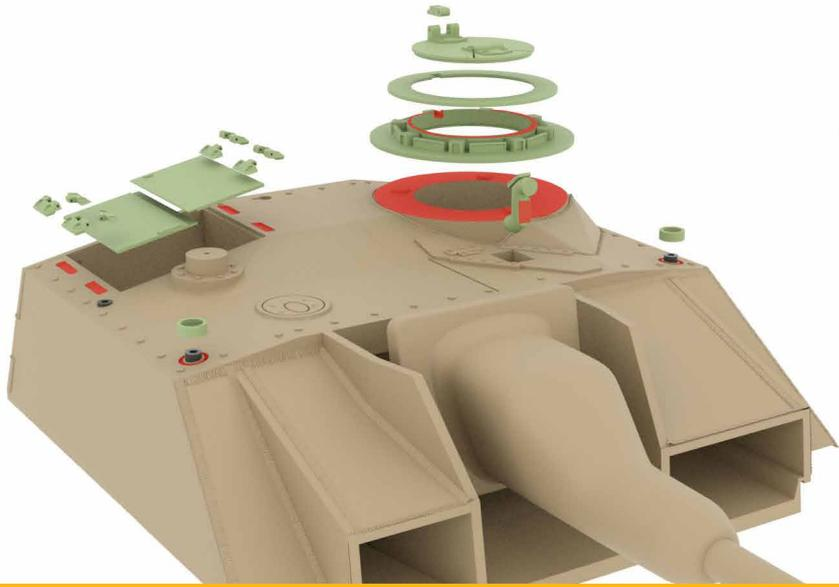

Files:

- B-40-1x
- B-41-1x
- B-42-1x
- B-43-2x
- B-44-6x
- B-45-1x



Files:

- B-46-1x
- B-47-1x
- B-48-1x
- B-49-1x
- B-50-1x
- B-51-1x

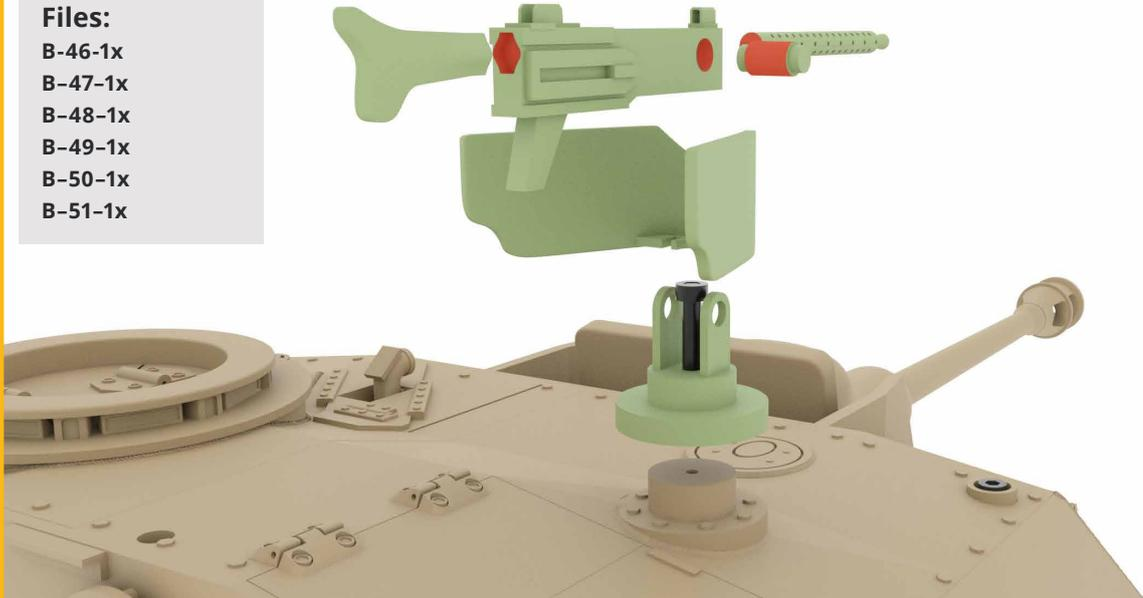

D

Files:

- D-1-right-1x
- D-1-left-1x
- D-2-right-1x
- D-2-left-1x
- D-3-right-1x
- D-3-left-1x
- D-4-right-1x
- D-4-left-1x

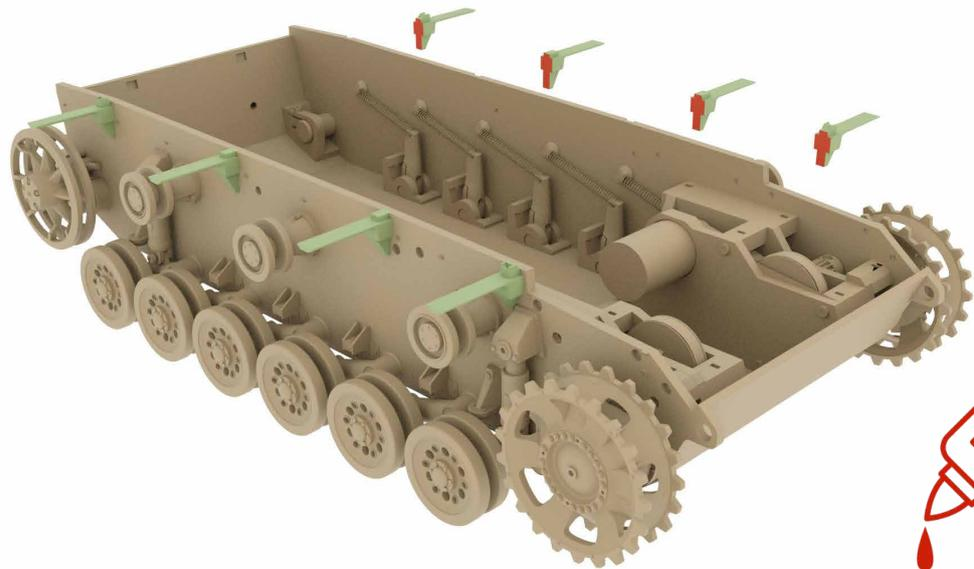

Files:

- D-5-right-1x
- D-5-left-1x
- D-6-right-1x
- D-6-left-1x
- D-7-right-1x
- D-7-left-1x
- D-8-right-1x
- D-8-left-1x
- D-9-right-1x
- D-9-left-1x

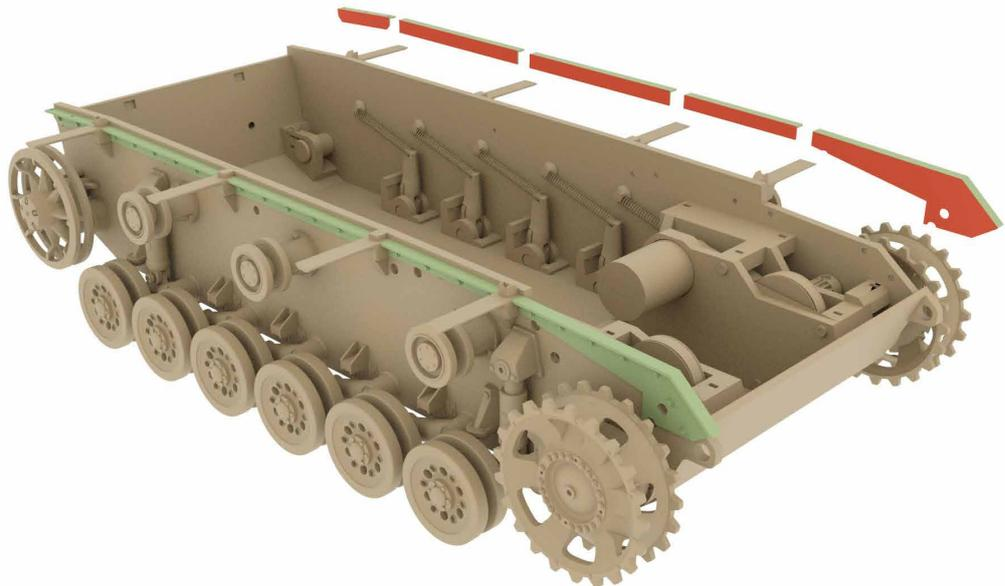

Files:

- D-10-right-1x
- D-10-left-1x
- D-11-right-1x
- D-11-left-1x
- D-12-right-1x
- D-12-left-1x

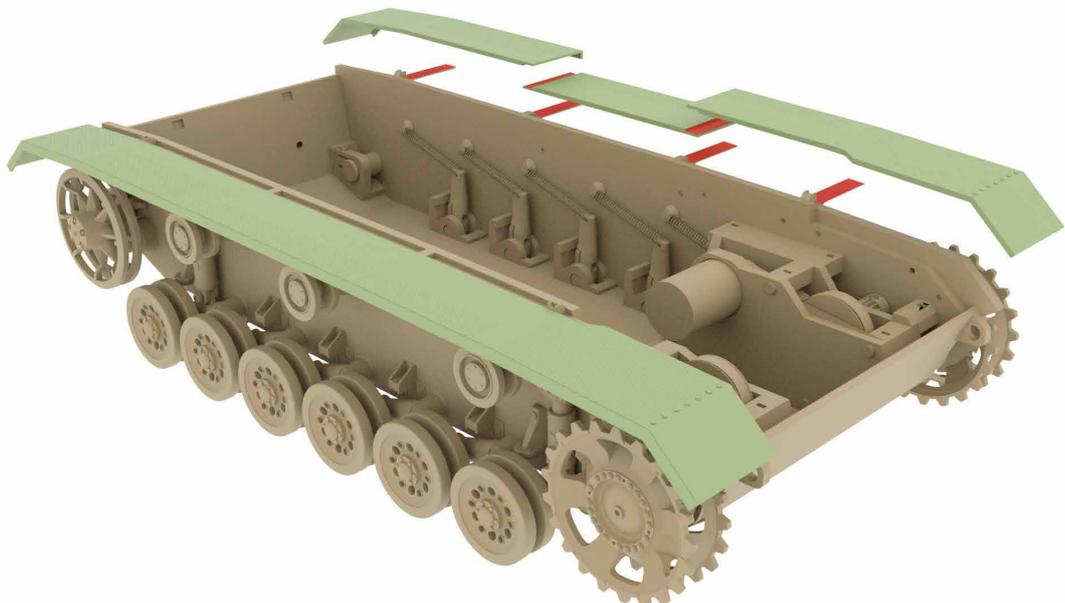

Files:
D-13-4x



Files:
E-1-1x
E-2-1x

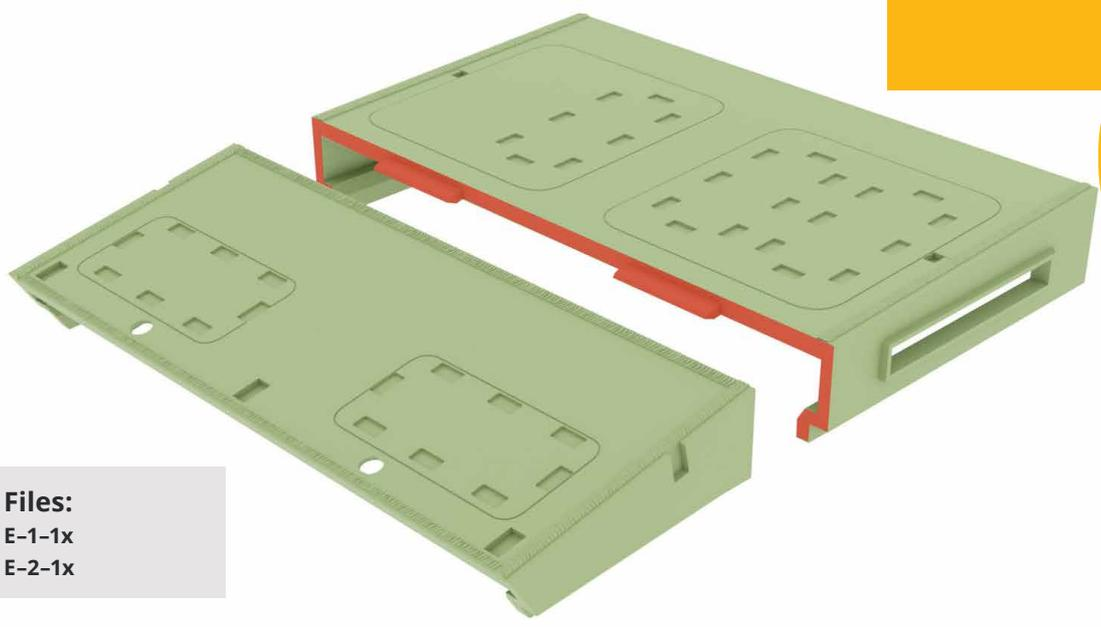

Files:
E-3-5x
E-4-40x

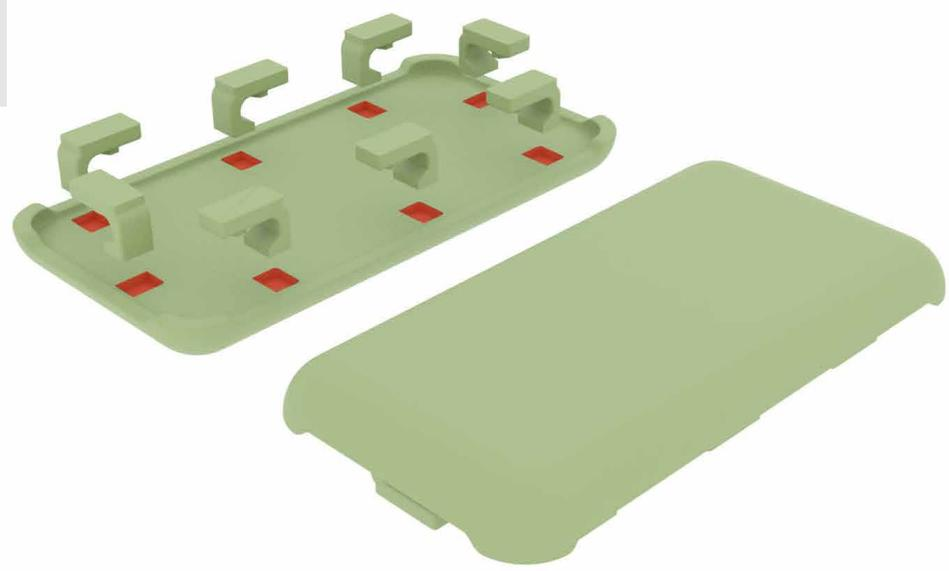

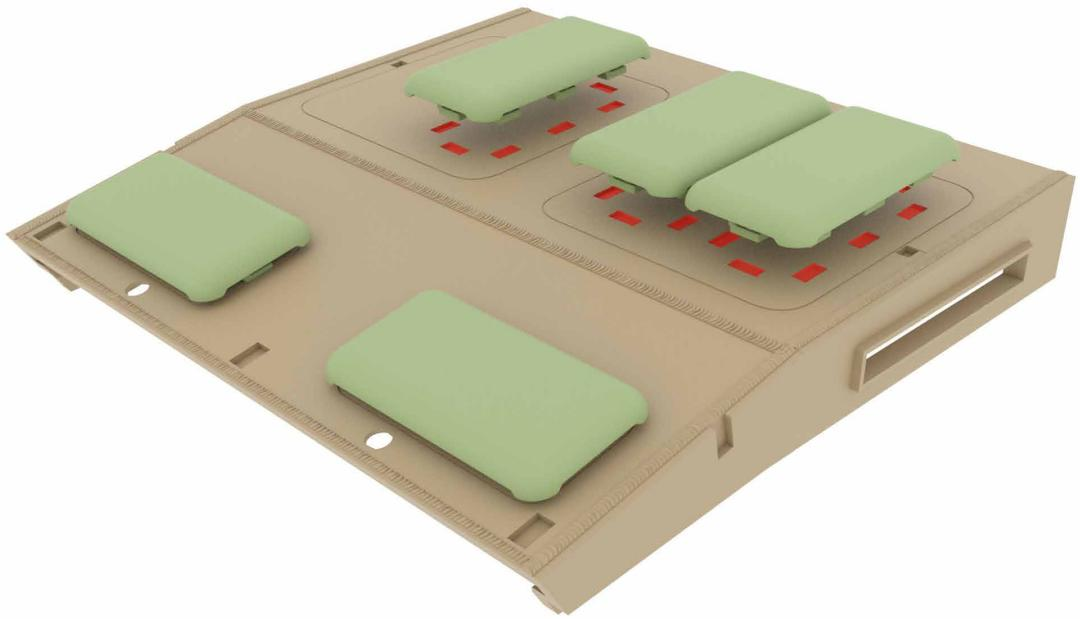

Files:

- E-5-1x
- E-5-right-1x
- E-5-left-1x
- E-6-2x
- E-7-right-1x
- E-7-left-1x

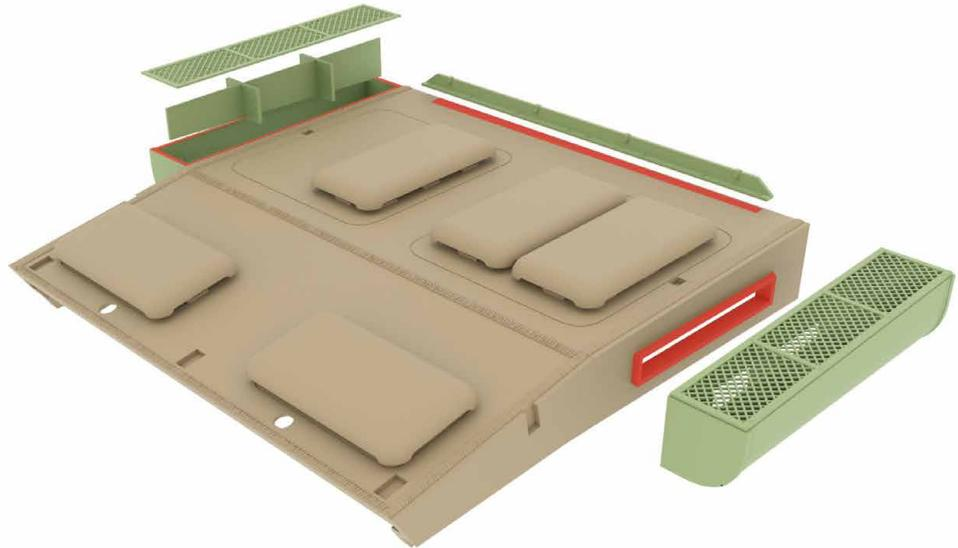

Files:

- E-7-2x

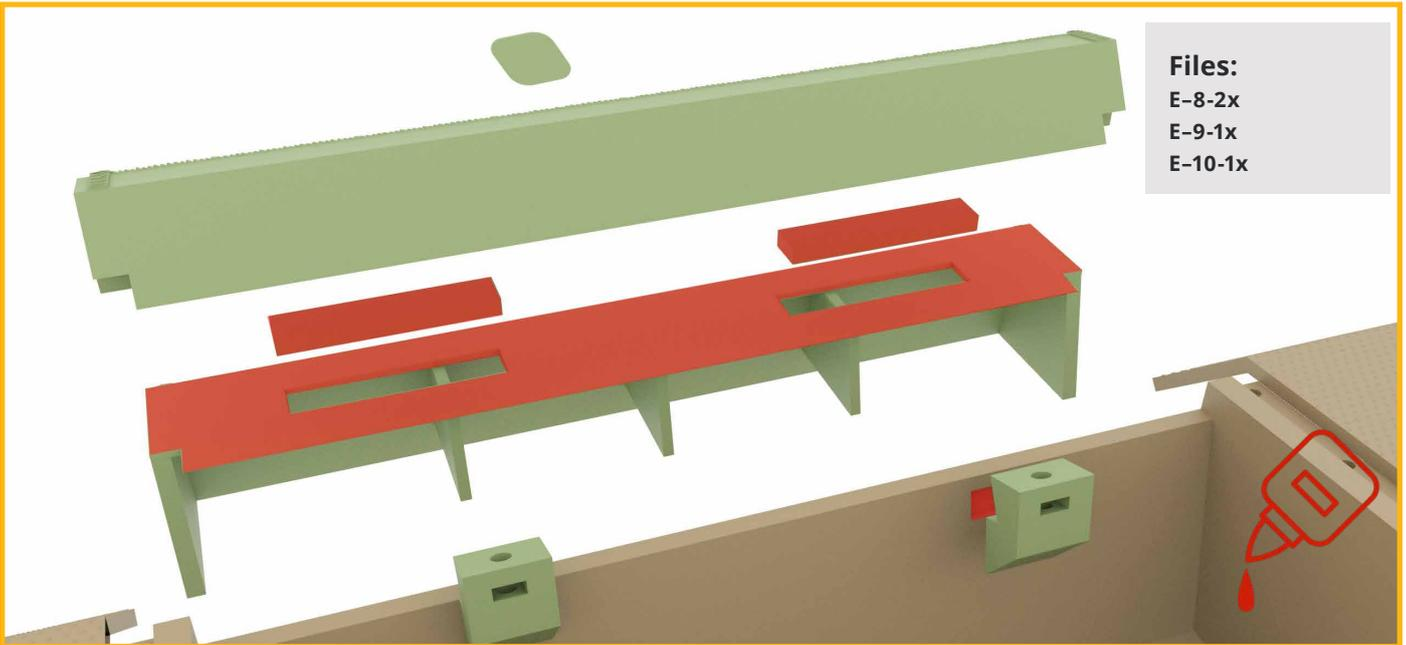

**Files:**

M3 16mm 12x

**Files:**

M3 16mm 2x

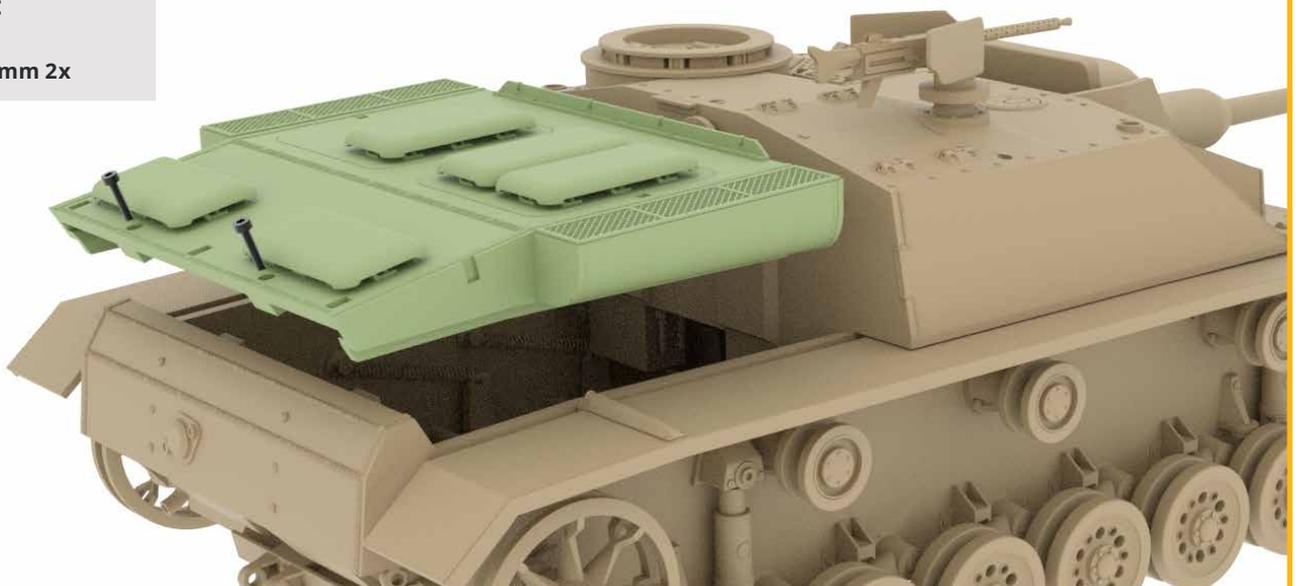

F

Files:

E-1-1x
E-2-1x
F-3-1x

Files:

F-4-1x
F-5-1x

Files:

F-6-right-1x
F-6-left-1x
F-7-right-1x
F-7-left-1x
F-8-right-1x
F-8-left-1x
F-9-right-1x
F-9-left-1x
F-10-right-1x
F-10-left-1x
F-16-2x
F-17-5x



Files:

F-11-1x
F-12-1-1x
F-12-2-1x
F-13-1x
F-14-1x
F-15-1x

M3 16mm 1x

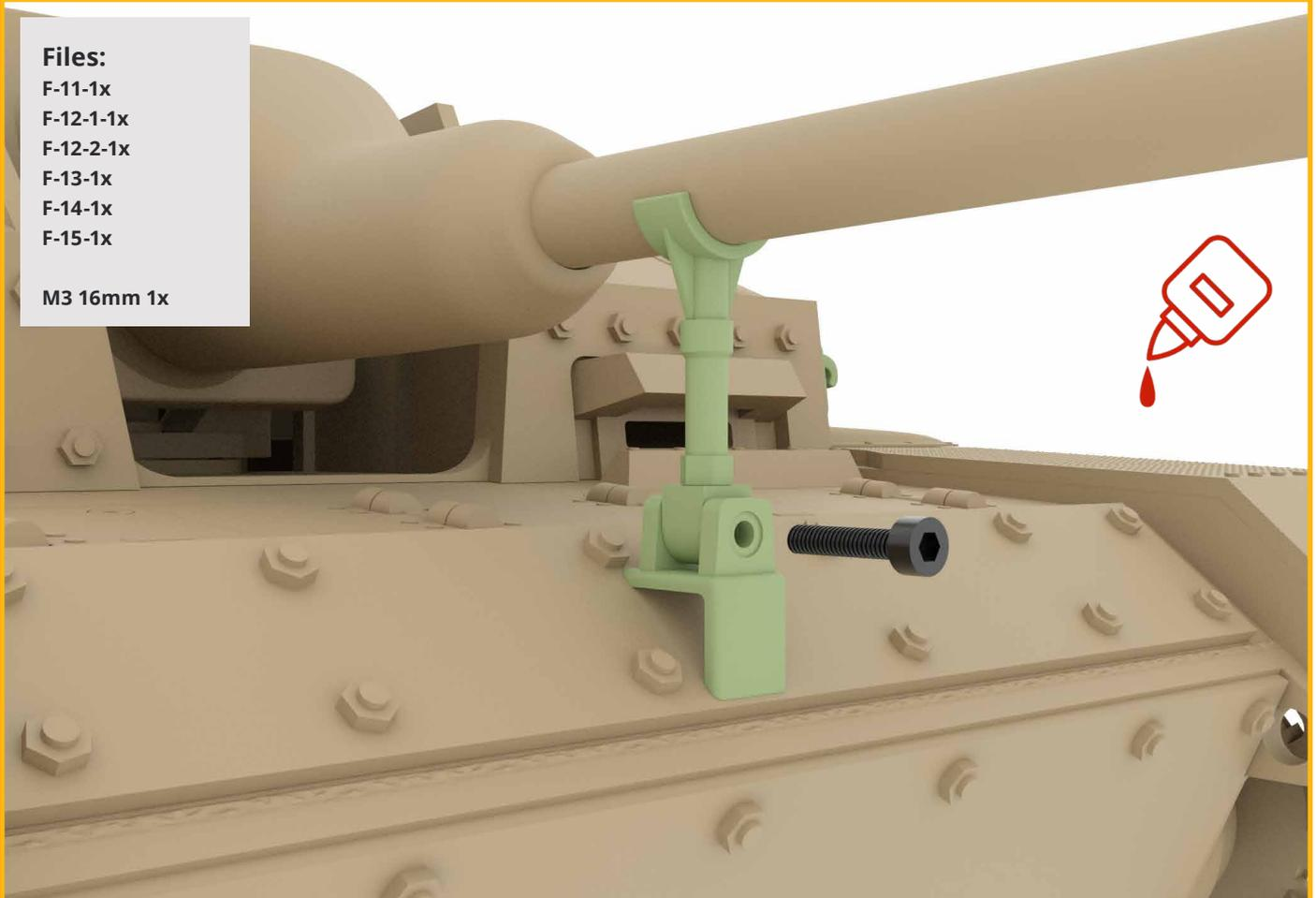
**Files:**

F-17-5x
F-18-2x
F-19-2x
F-20-3x
F-21-1x
F-22-1x
F-23-1x
F-24-1x
F-25-1x
F-26-FLEX-2x
F-27-1x
F-28-1x

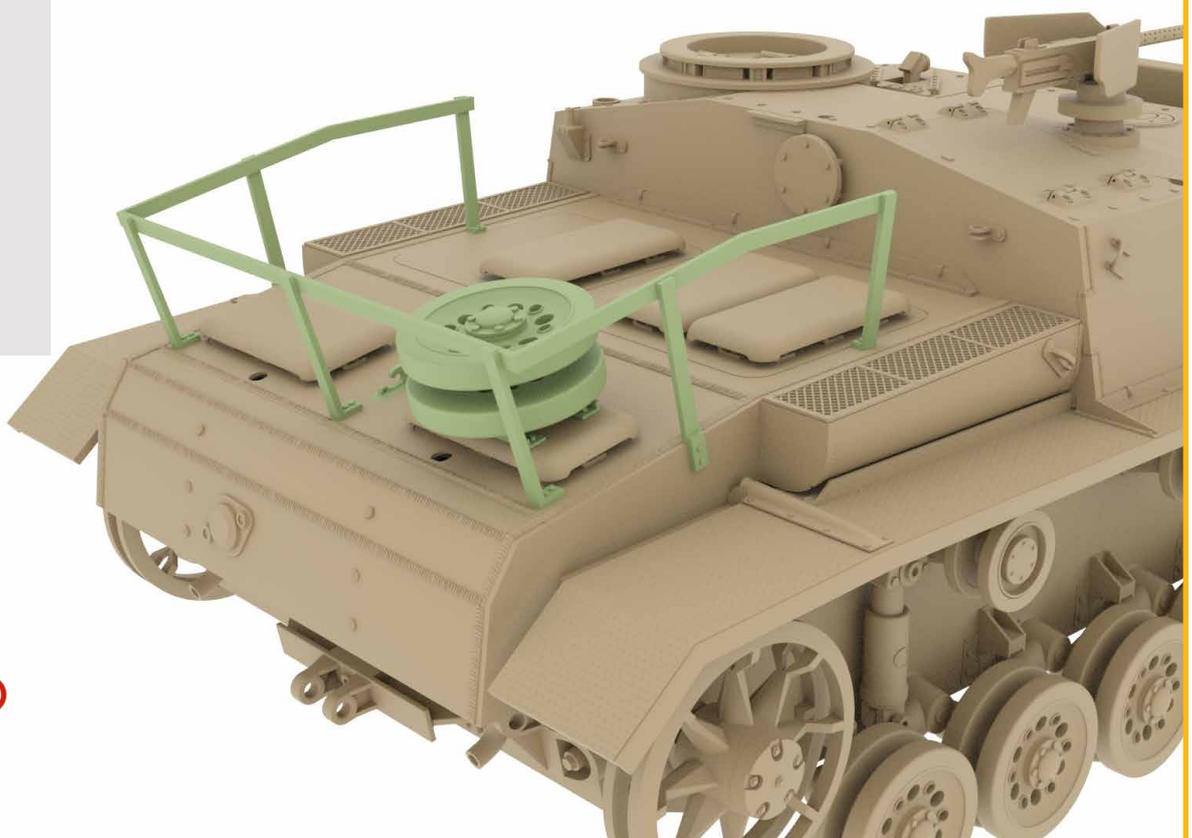

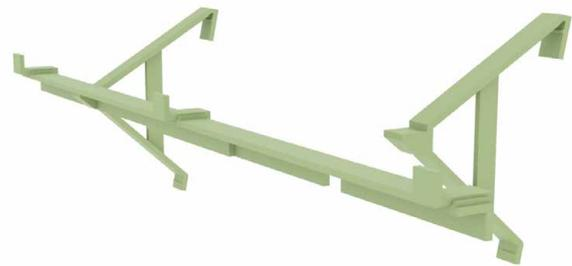
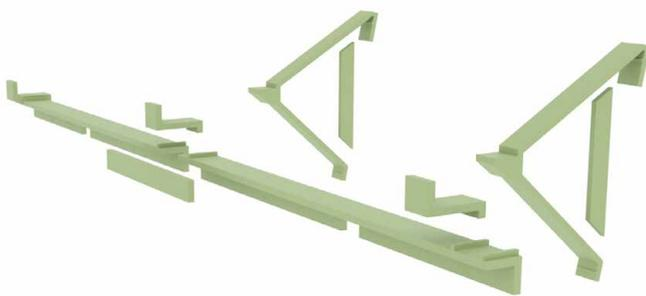
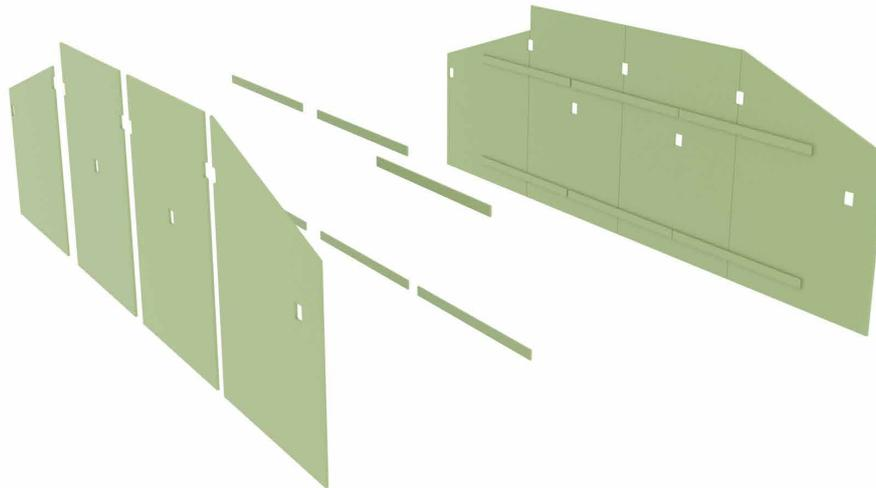

Files:

- F-29-right-1x
- F-29-left-1x
- F-30-right-1x
- F-30-left-1x
- F-31-right-1x
- F-31-left-1x
- F-32-right-1x
- F-32-left-1x
- F-33-2x
- F-33-right-1x
- F-33-left-1x
- F-34-4x
- F-35-2x
- F-36-4x
- F-36-right-1x
- F-36-left-1x
- F-37-4x
- F-38-right-1x
- F-38-left-1x
- F-39-right-1x
- F-39-left-1x
- F-40-2x
- F-41-6x
- F-42-4x
- F-43-4x
- F-44-4x
- F-45-12x

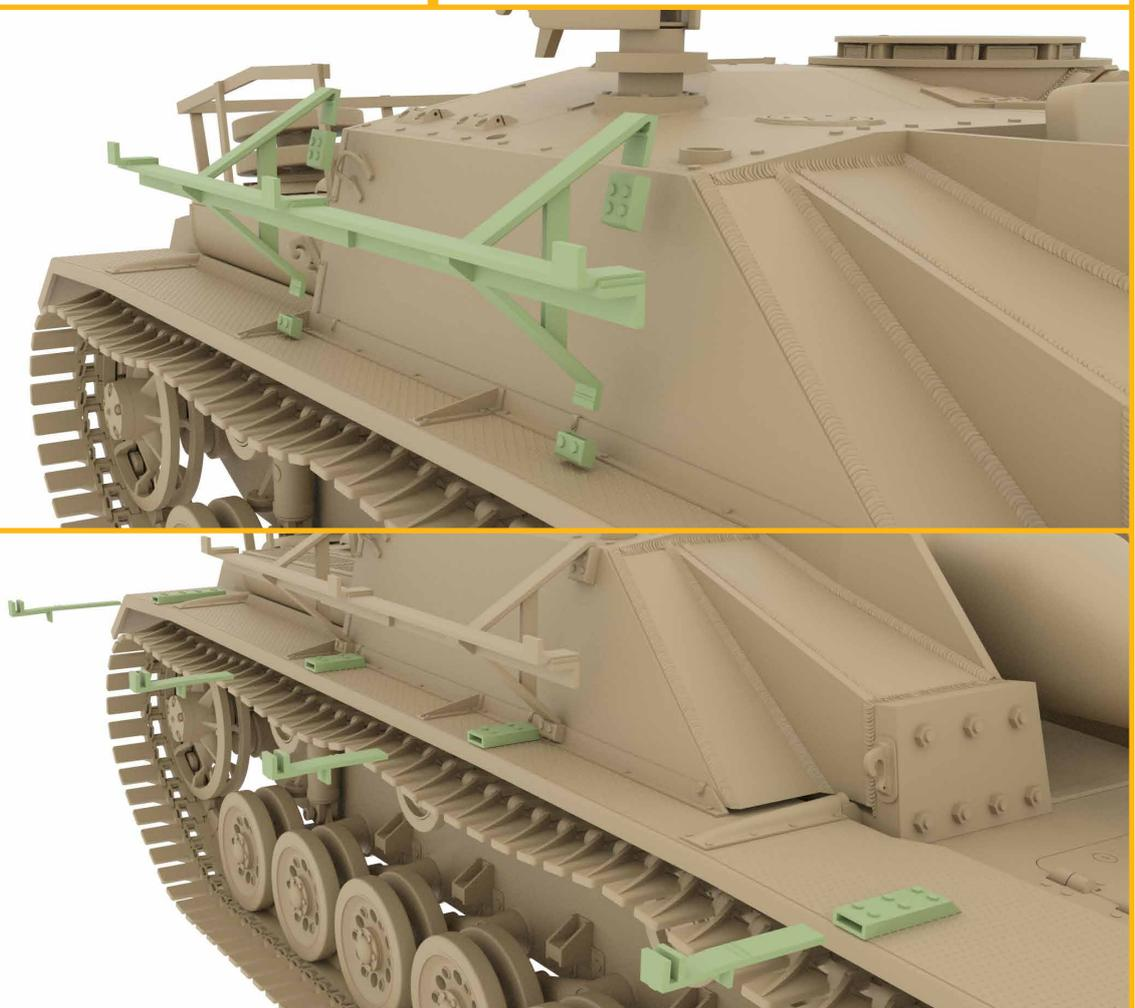

Files:

F-29-right-1x
F-29-left-1x
F-30-right-1x
F-30-left-1x
F-31-right-1x
F-31-left-1x
F-32-right-1x
F-32-left-1x
F-33-2x
F-34-4x
F-35-2x
F-36-4x
F-37-4x
F-38-left-1x
F-38-right-1x
F-39-left-1x
F-39-right-1x
F-40-2x
F-41-6x

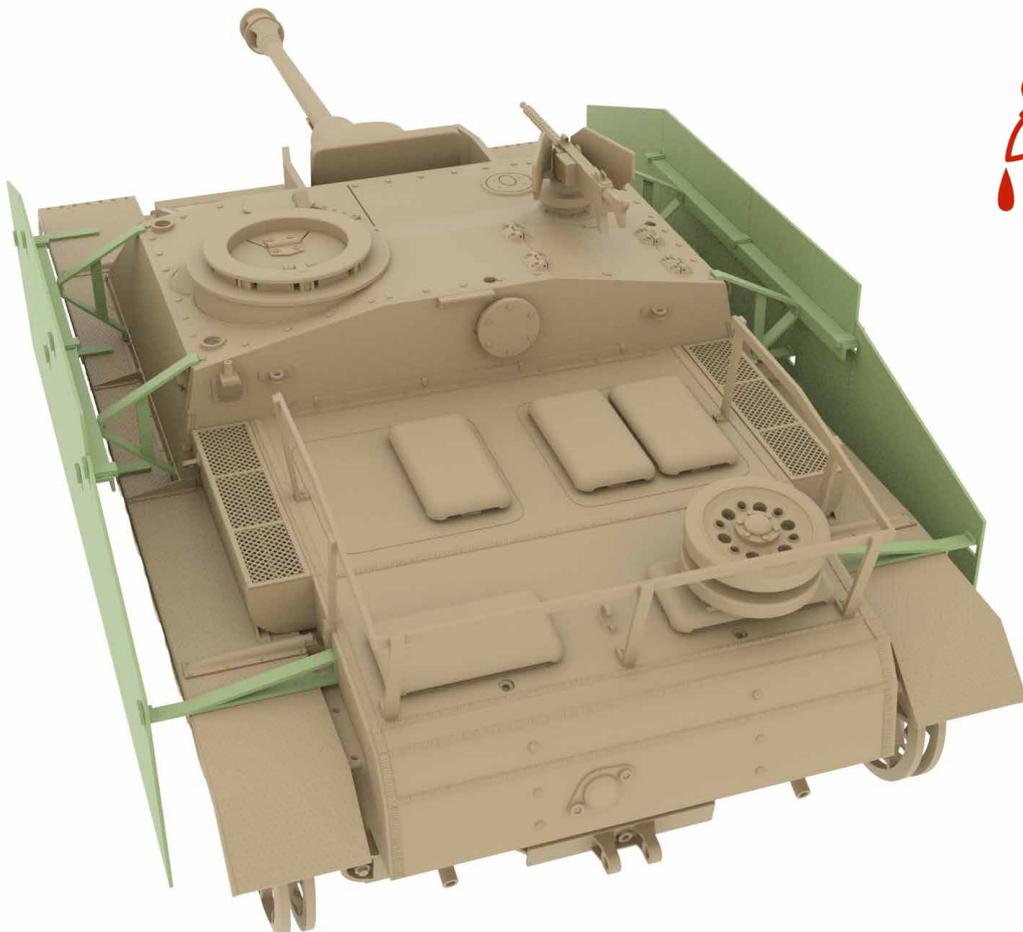
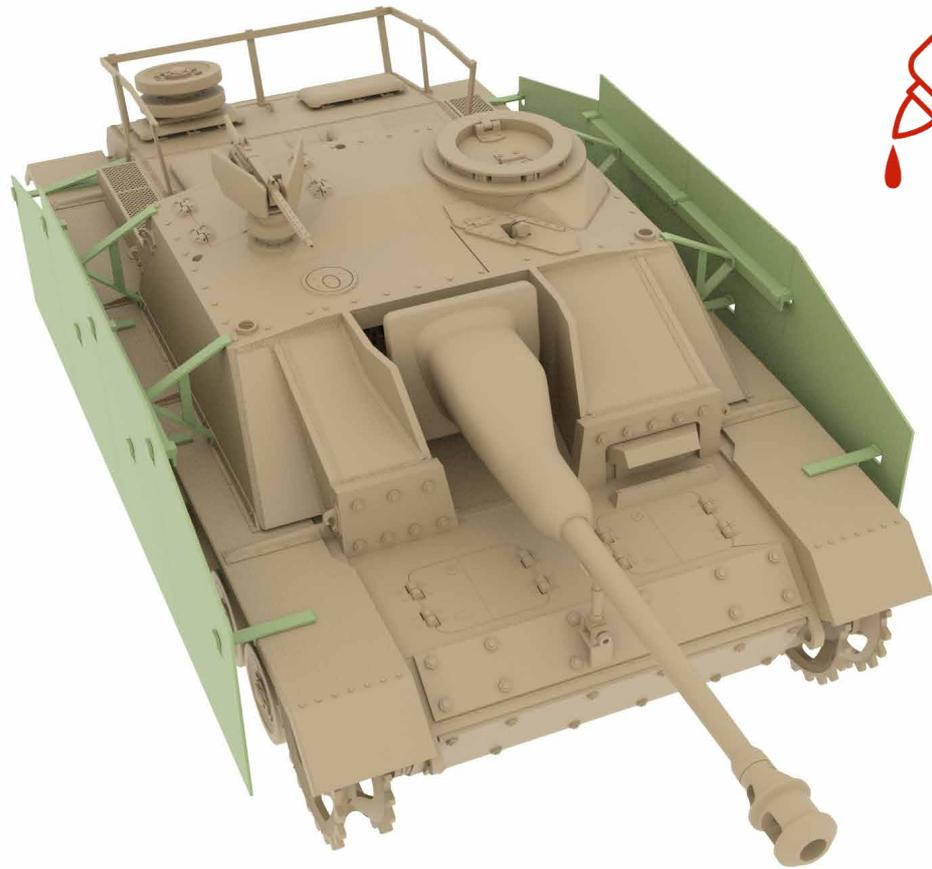

G



Files:

G-1-188x

G-2-188x

G-3-right-94x

G-3-left-94x



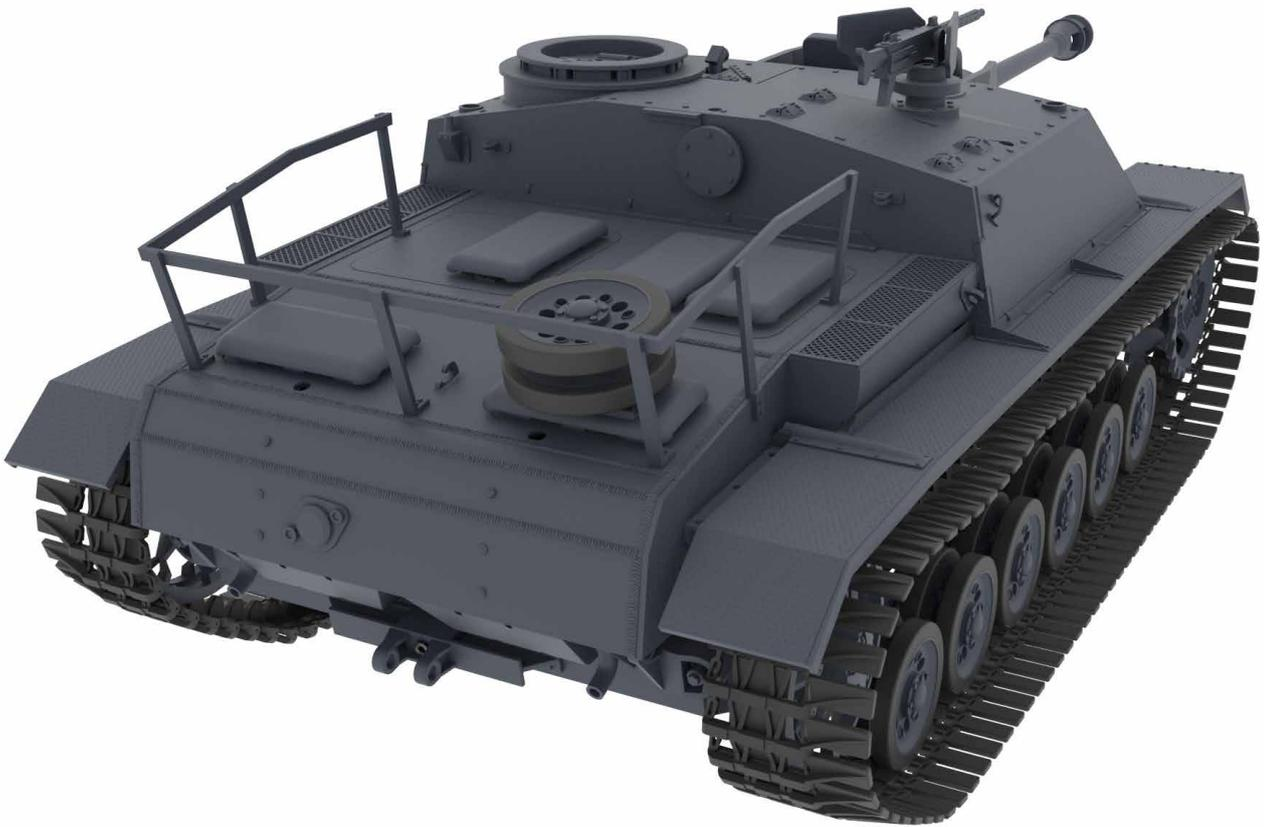



autor: **Petr Školař**
web: **www.3dtiks.store**
e-mail: **3dtisk@gpstudio.cz**