

VERZE 1.2.

2024



# Sturmgeschutz III

StuG III Ausf.

1:10

A



UPDATE – V-1.2.



# NÁVOD KE STAVBĚ

[www.3dtisk.store](http://www.3dtisk.store)

# Stavební manuál

## 3d tisk

### Nastavení :

Nastavení tisku: **0.20mm** (u spojovacích dílů **0.15mm** přesnější např. vkládání kuličkových ložisek)

Výplň: **15%** (u pohyblivých částí **100%** např. převodovky)

Filament: **PLA 3 Kg**  
Souborů STL: **233 ks**  
Délka tisku: **9 dní**

## UPDATE V-1.2.

kombinovaná převodovka, silnější hnací osa, jednodušší sestavení, vyměnitelné díly, nové napínání pásů

## Spojovací materiál

### Šrouby

M3 x 16mm = 100ks

M3 x 10mm = 8ks

### Ložiska:

Kuličkové ložisko 10 x 15 x 4mm = 18ks

Kuličkové ložisko 12 x 21 x 5mm = 4ks

### XL rozvodový pás

70, zubů: 35 = 4ks

### Pružiny:

0,5 mm, 30 mm, 5 mm = 12ks

Drát vázací: tl. 1 mm

Sekundové lepodlo

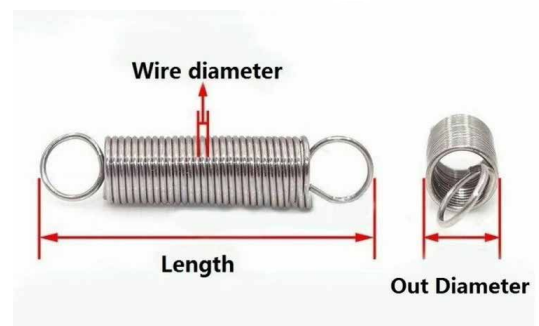

### **Motory:**

Stejnoseměrné motory 540

Rozměry (Ø x d) 35.8 mm x 50 mm

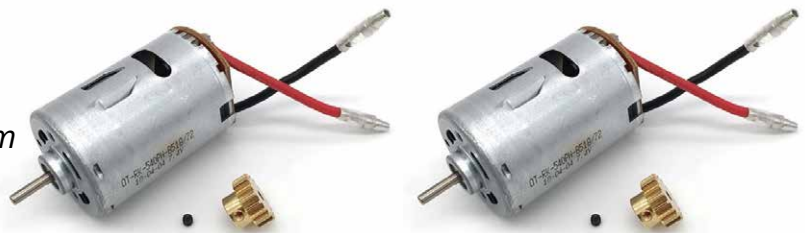

### **Regulátory:**

obousměrný elektrický regulátor rychlosti, pro  
stejnoseměrné motory.



### **Serva:**

20,3x38x40,5mm



## **SCHEMA ZAPOJENÍ**

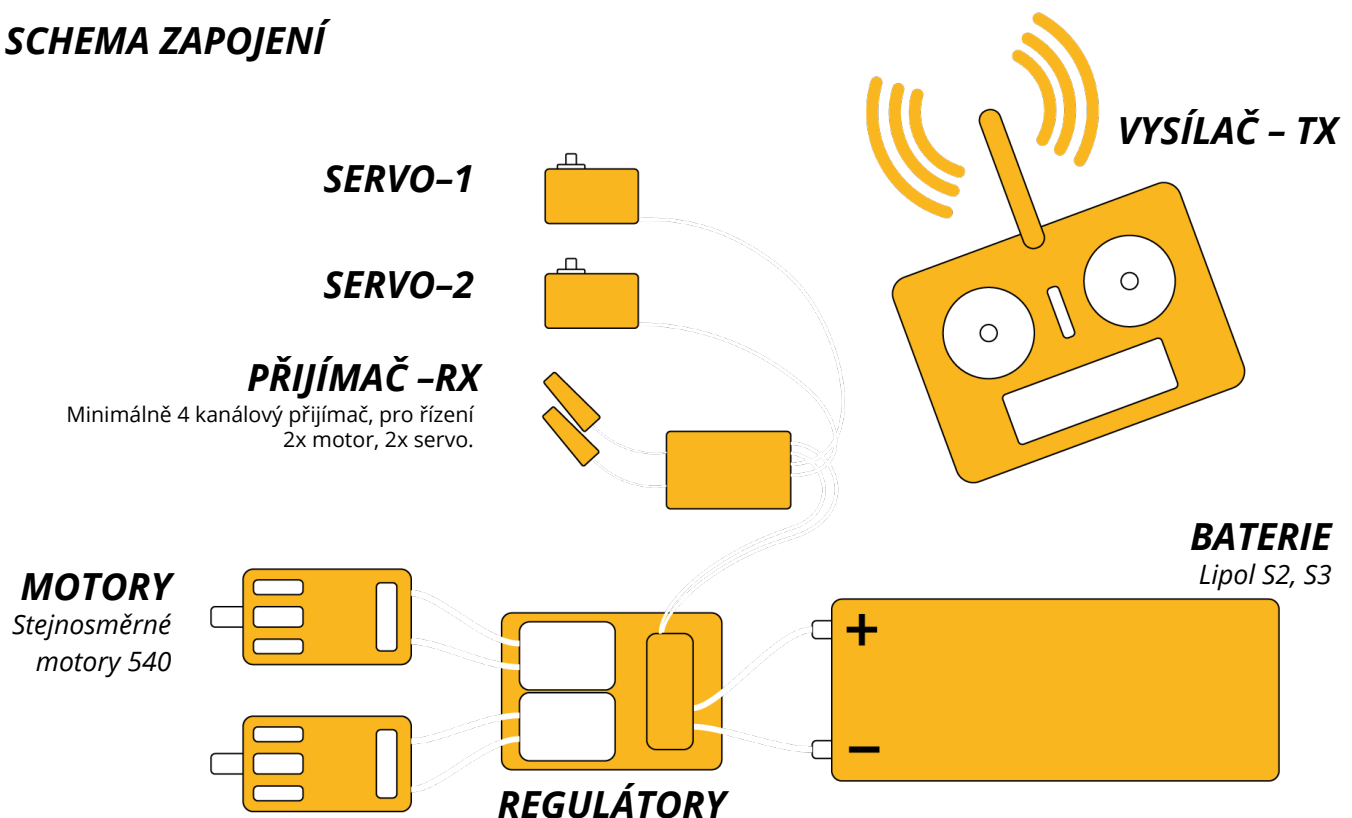

# Sturmgeschütz III

StuG III Ausf. A

## PARAMETRY MODELU

Měřítko: 1:10

Rozměr: 605 x 325 x 215 mm

Váha: 4,5 Kg

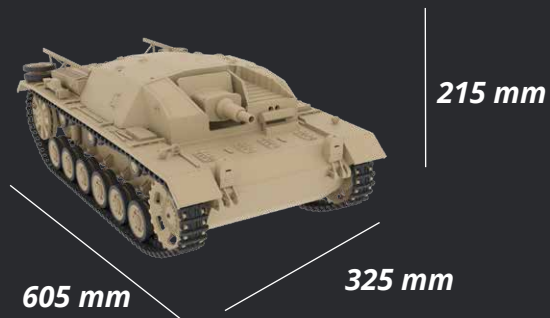

A

E

B

F

C

G

D

P

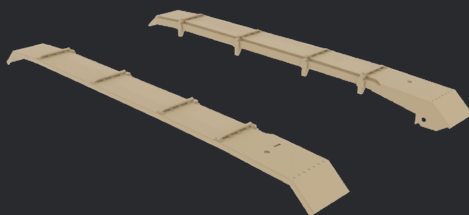
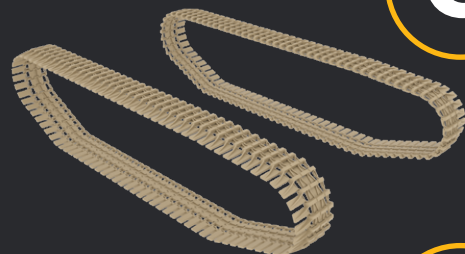

# StuG III

A

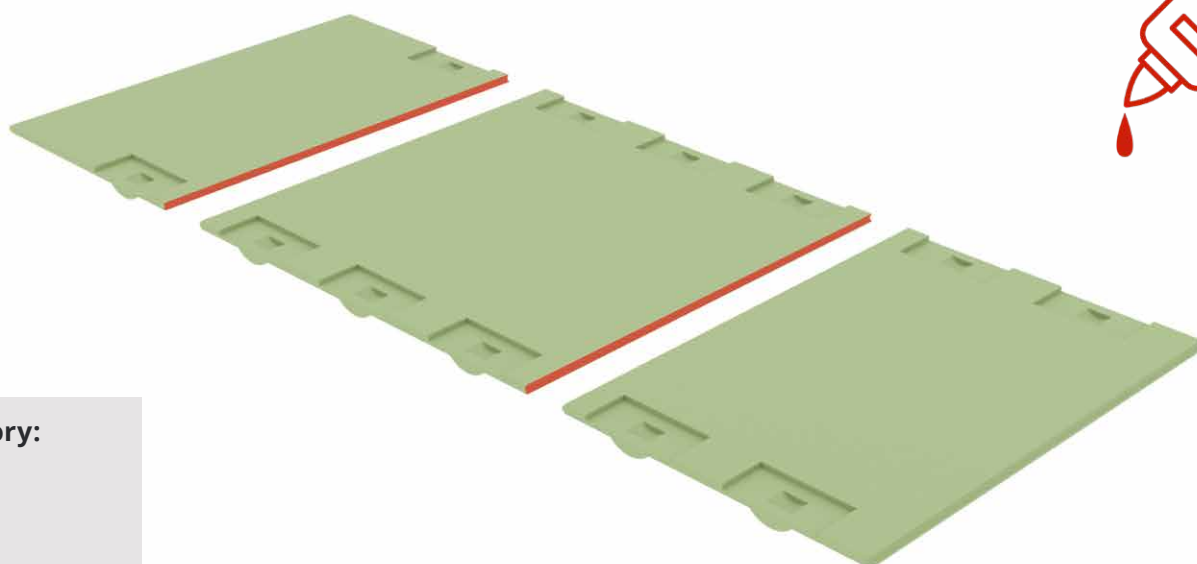
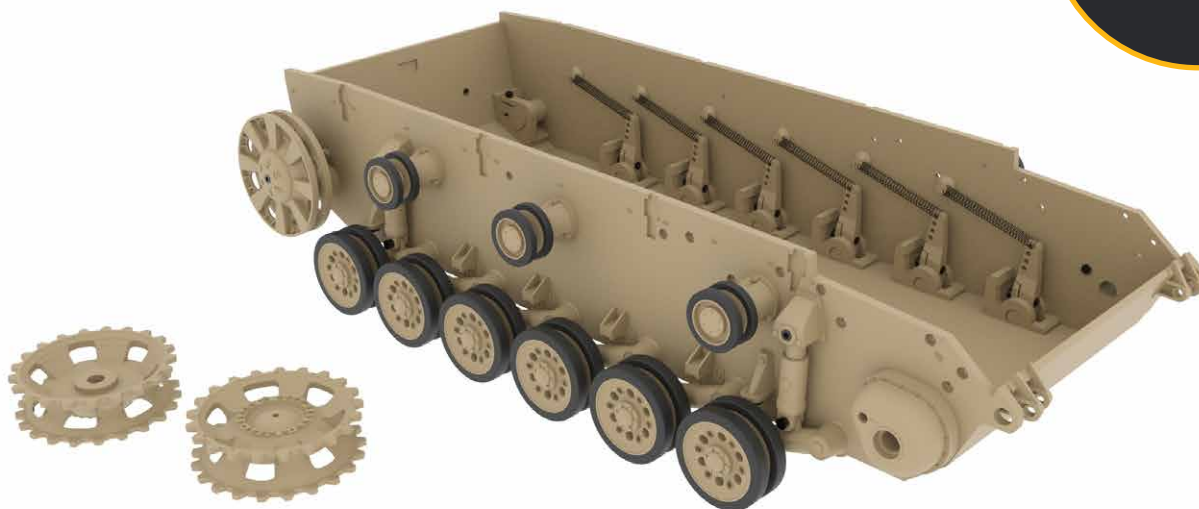

**Soubory:**

- A-1-1x
- A-2-1x
- A-3-1x

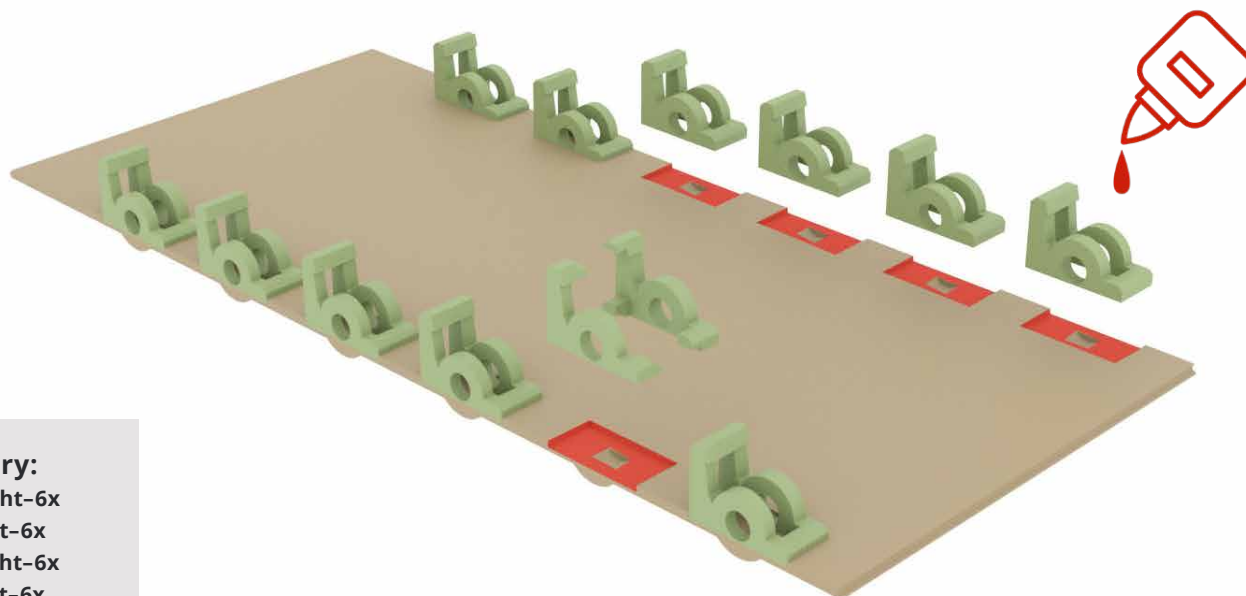

**Soubory:**

- A-4-right-6x
- A-4-left-6x
- A-5-right-6x
- A-5-left-6x

**Soubory:**

- A-6-right-1x
- A-6-left-1x
- A-7-right-1x
- A-7-left-1x
- A-8-right-1x
- A-8-left-1x

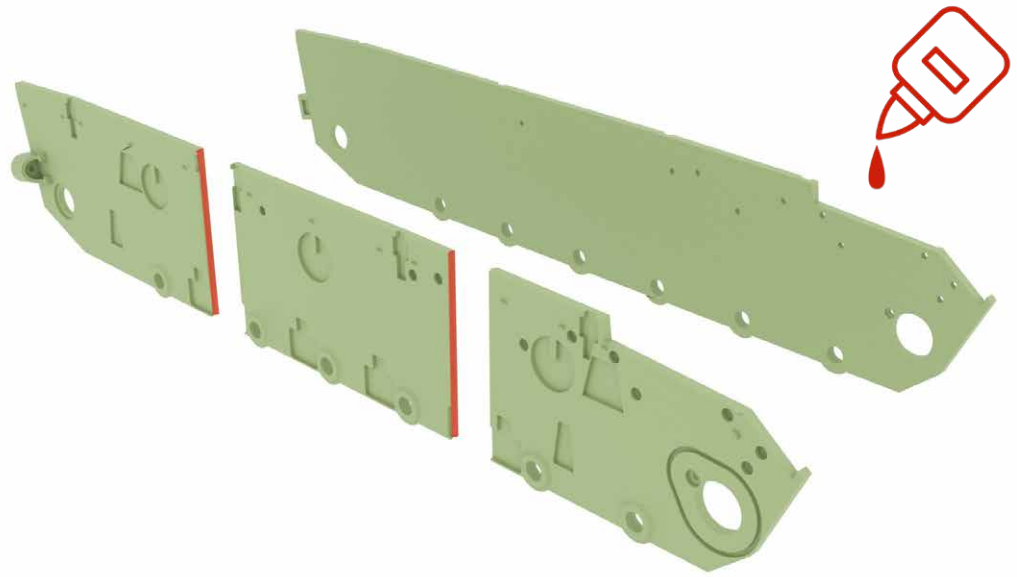

**Soubory:**

- A-11-1x
- A-12-right-1x
- A-12-left-1x

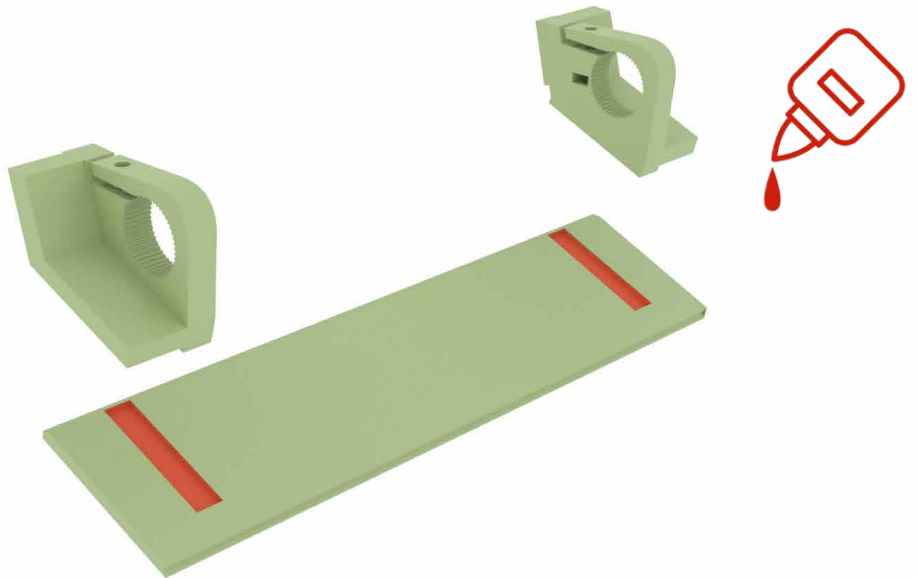

**Soubory:**

- A-9-1x
- A-10-1x
- A-11-1x
- A-12-right-1x
- A-12-left-1x
- A-13-1x

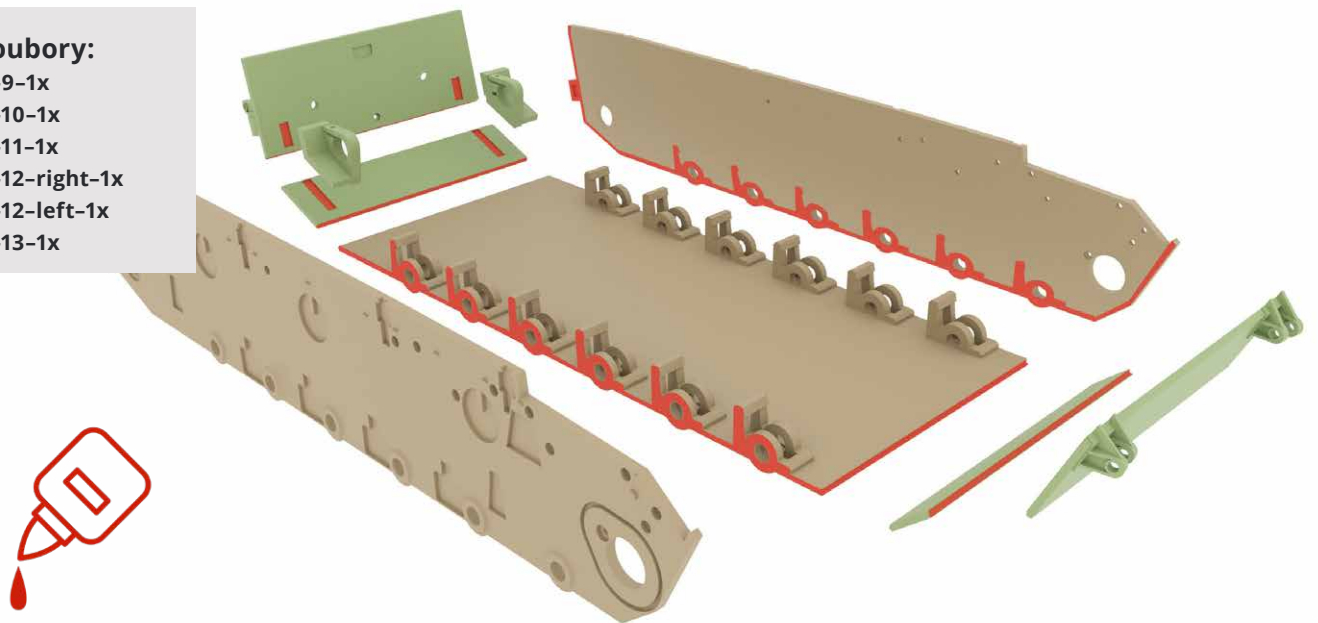

**Soubory:**  
A-14-4x  
A-15-FLEX-4x

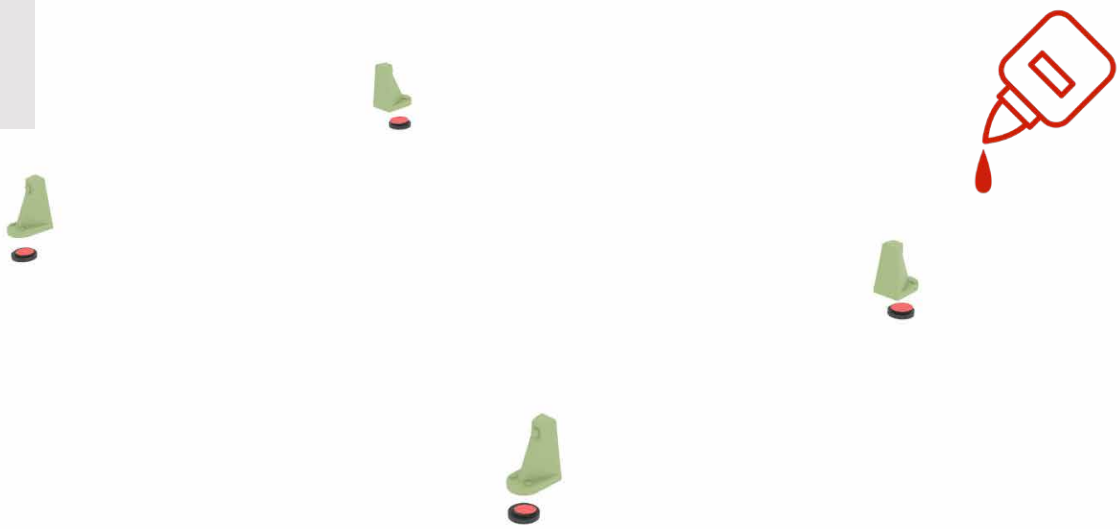

**Soubory:**  
A-14-4x  
A-15-FLEX-4x  
A-16-8x  
A-17-6x  
A-18-4x  
A-19-1-right-1x  
A-19-1-left-1x  
A-20-2x

M3 16mm 2x  
Ložisko-  
12x21x5mm-2x

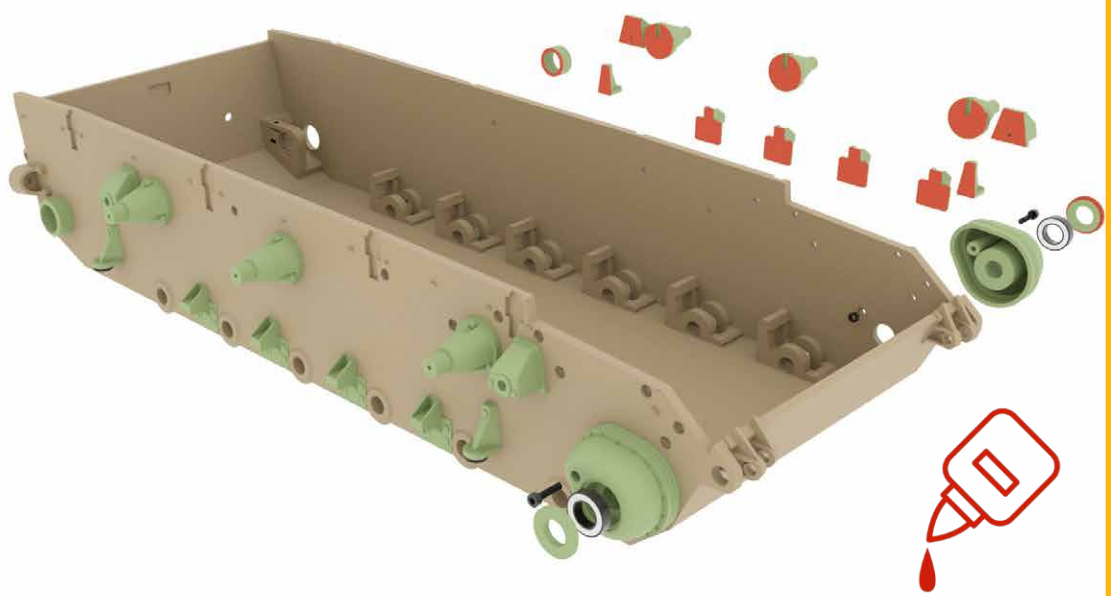

**Soubory:**  
A-21-6x  
A-22-6x  
A-23-12x  
A-24-FLEX-12x  
M3 16mm 6x

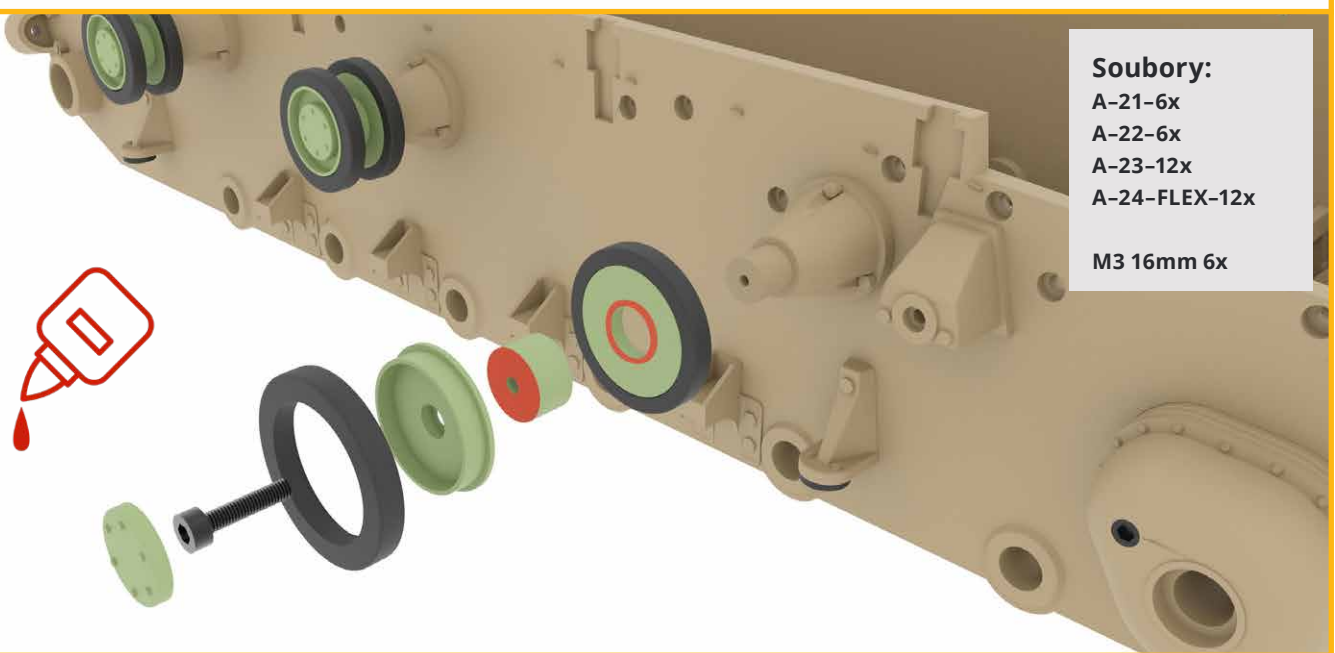

**Soubory:**

A-25-12x

A-26-12x

A-27-12x

A-28-12x

A-29-FLEX-24x

Ložisko-

10x15x4mm-12x

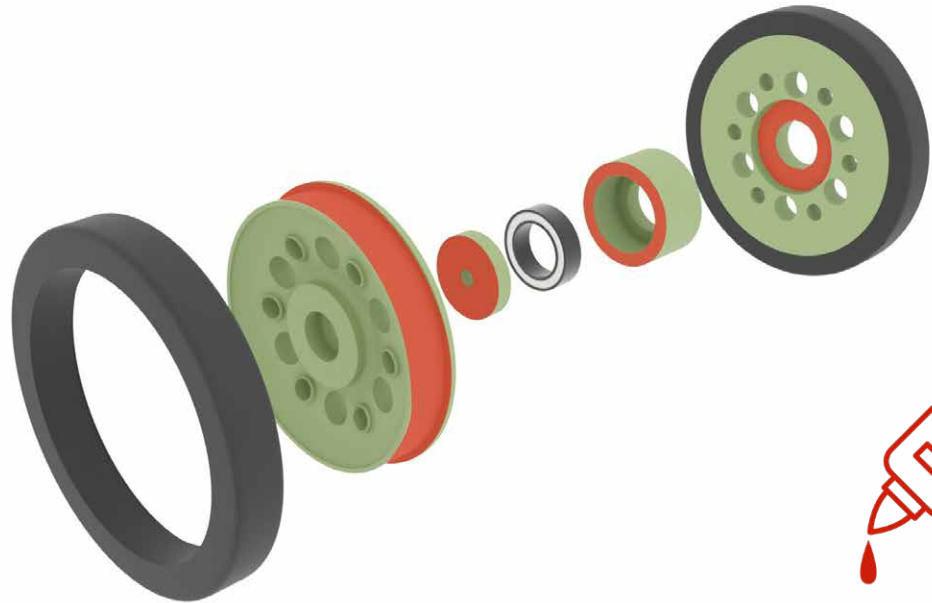
**Soubory:**

A-30-12x

A-31-right-2x

A-31-left-2x

A-32-12x

A-32-right-4x

A-32-left-4x

M3 16mm 12x

**Soubory:**

A-33-4x

A-34-4x

M3 10mm 8x





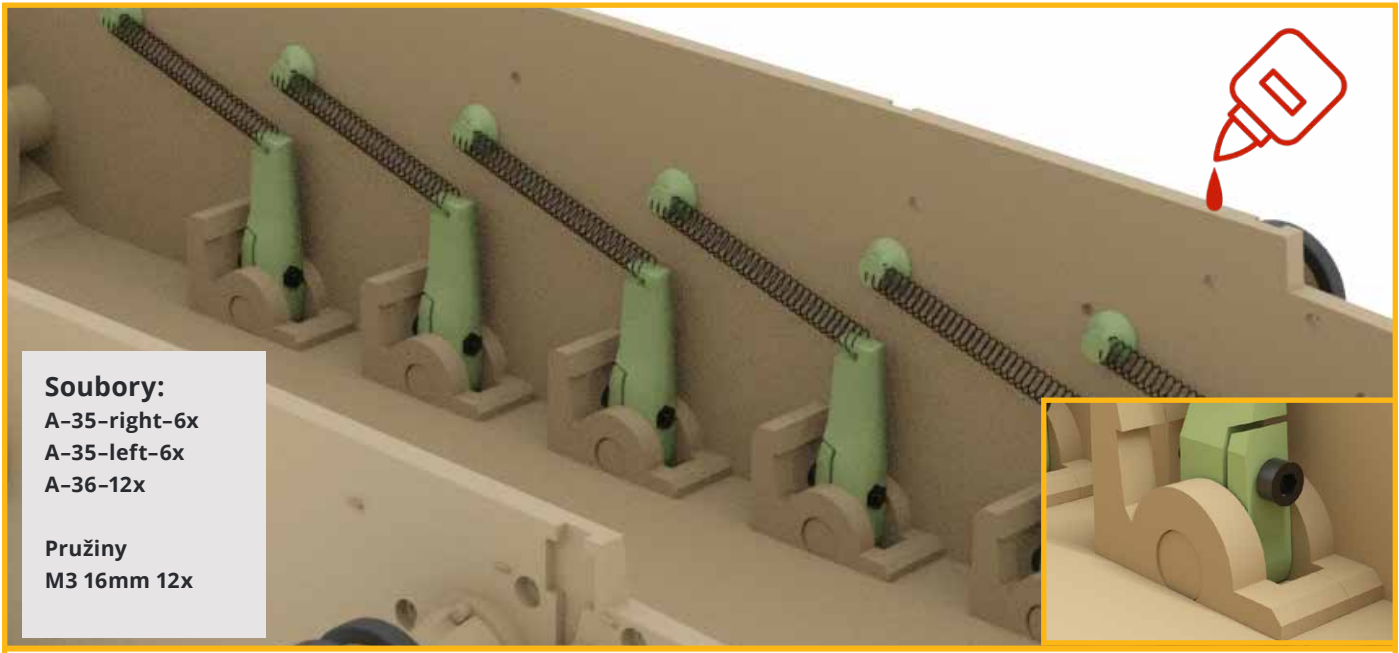

**Soubory:**  
A-35-right-6x  
A-35-left-6x  
A-36-12x

**Pružiny**  
M3 16mm 12x

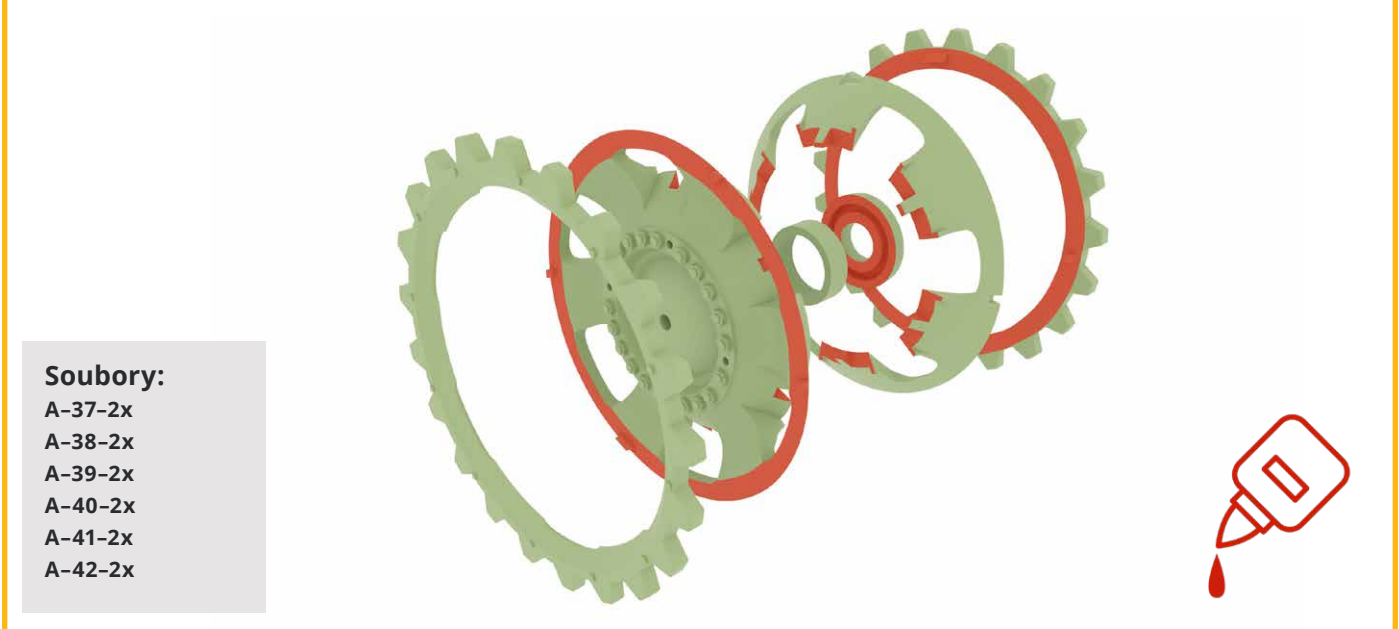

**Soubory:**  
A-37-2x  
A-38-2x  
A-39-2x  
A-40-2x  
A-41-2x  
A-42-2x

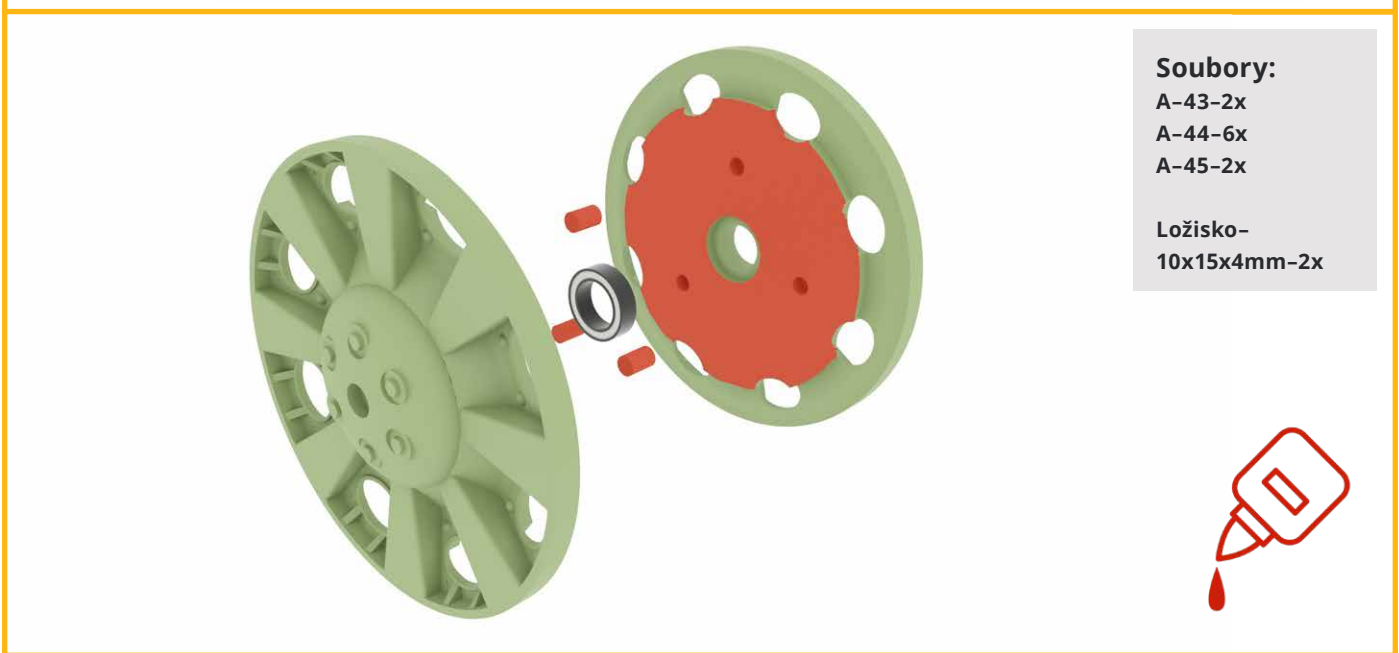

**Soubory:**  
A-43-2x  
A-44-6x  
A-45-2x

**Ložisko-**  
10x15x4mm-2x

**Soubory:**

- A-49-2x
- A-50-right-1x
- A-50-left-1x
- A-51-2x
- A-52-2x

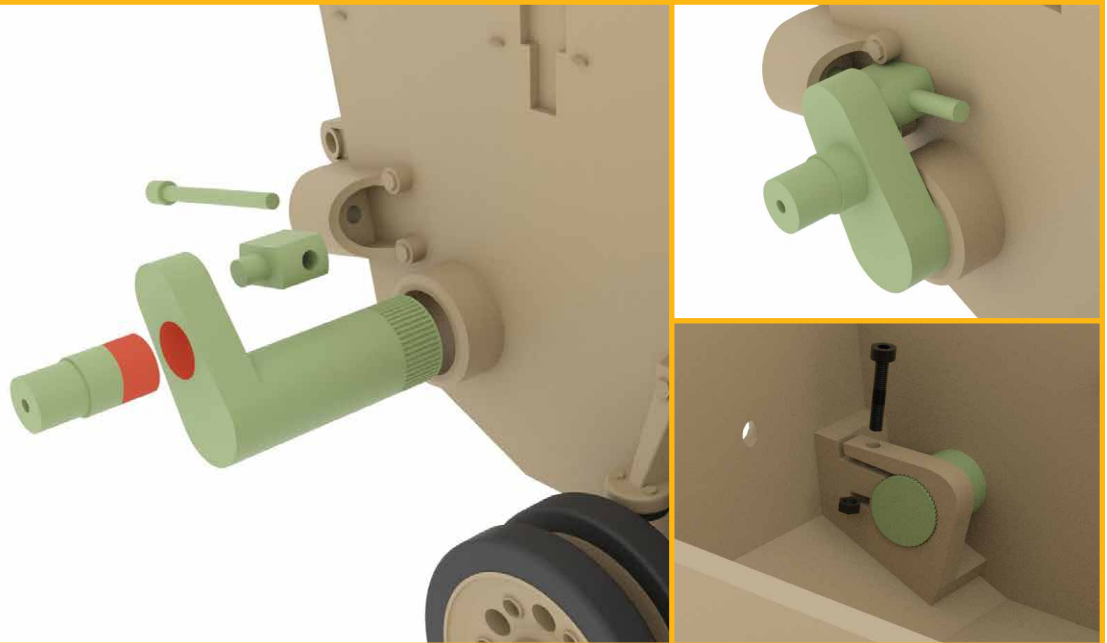

**Soubory:**

- M3 16mm 2x



**Soubory:**

- A-53-right-1x
- A-53-left-1x
- A-54-right-1x
- A-54-left-1x
- A-55-1x
- A-56-1x
- A-57-1x

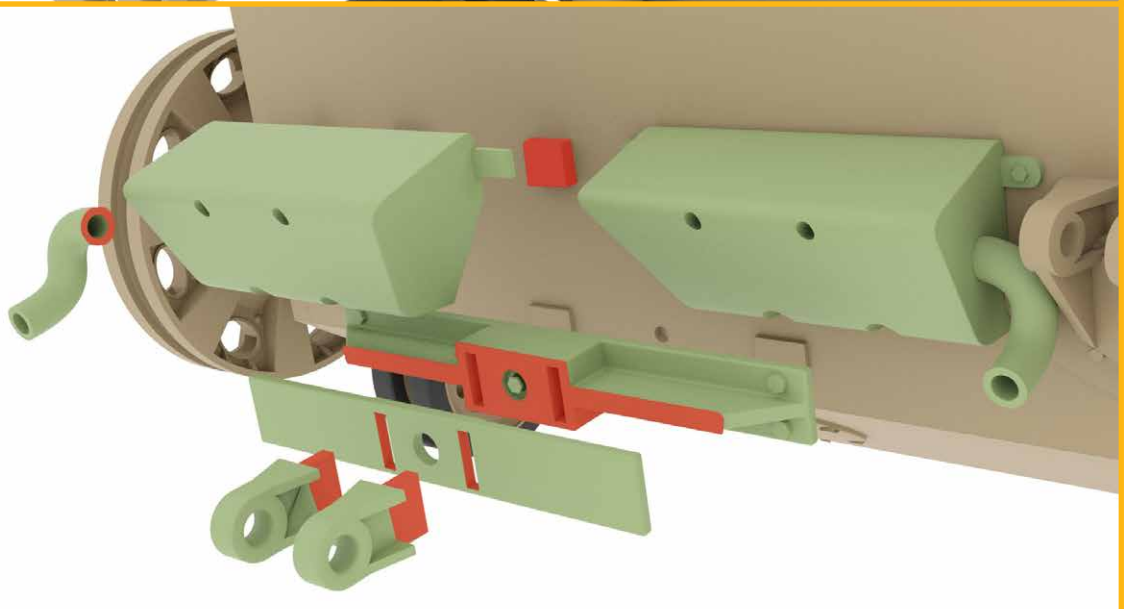

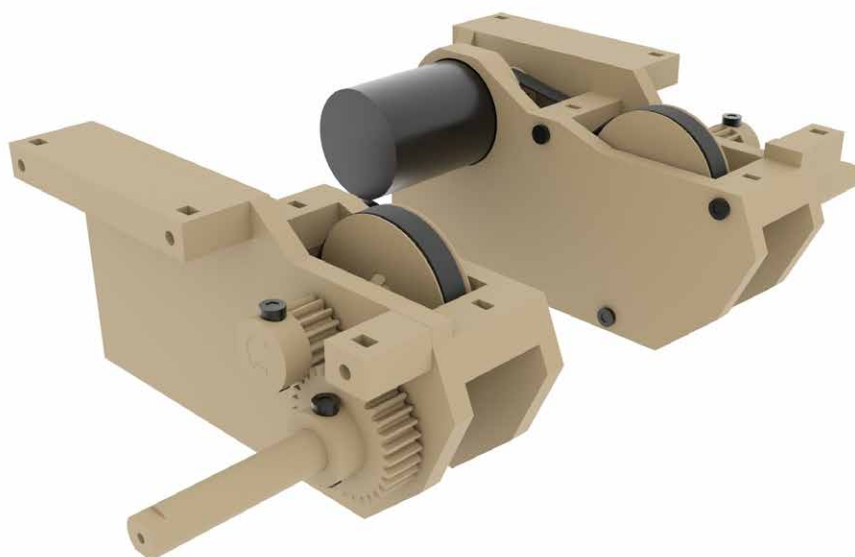

**Soubory:**

- P-1-right-1x
- P-1-left-1x
- P-2-right-1x
- P-2-left-1x
- P-3-right-1x
- P-3-left-1x

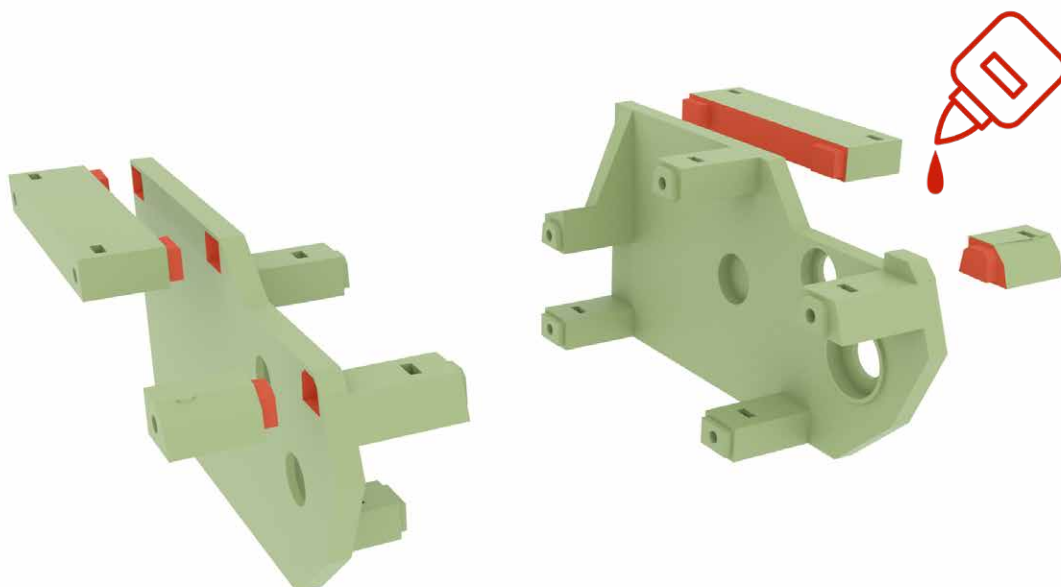

**Soubory:**

- P-4-2x
- P-5-2x
- M3 16mm 2x
- Ložisko-  
12x21x5mm-2x

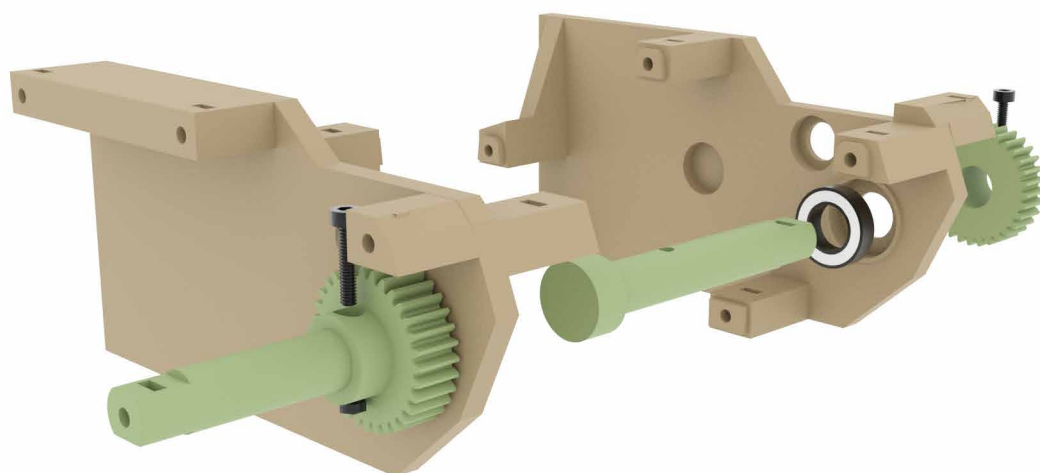

**Soubory:**

P-6-2x

P-7-2x

P-8-2x

P-9-2x

P-10-2x

**Ložisko-**

10x15x4mm-4x

M3 16mm 2x

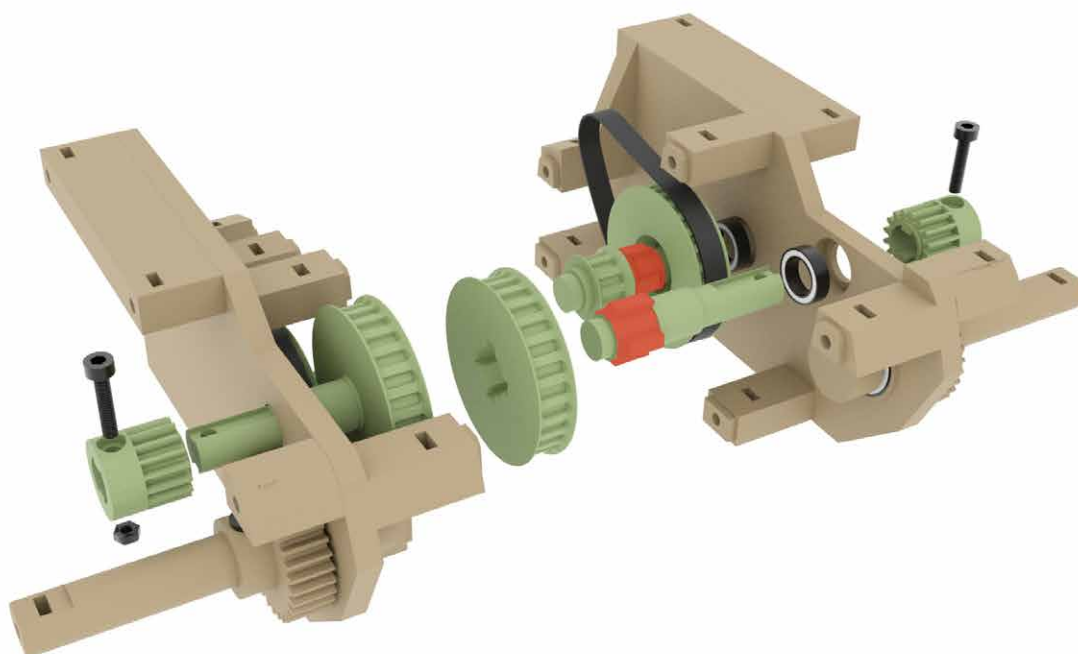
**Soubory:**

P-11-2x

P-12-right-1x

P-12-left-1x

M3 16mm 2x

10x15x4mm-4x

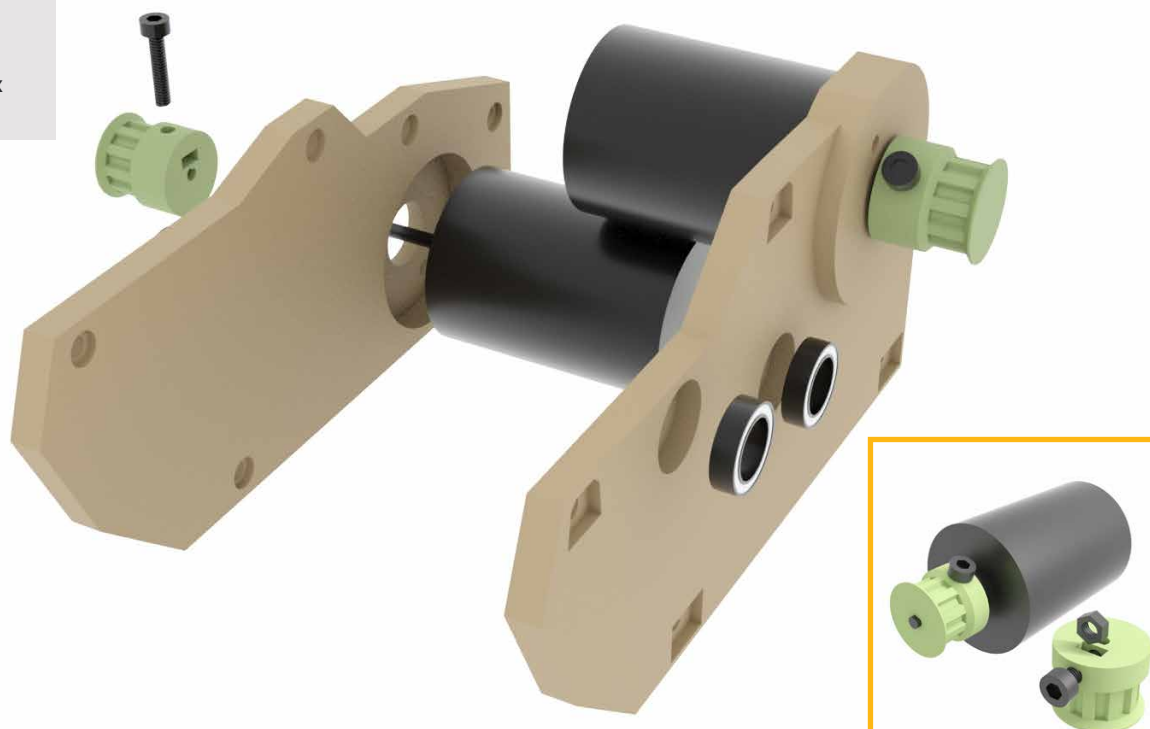



Soubory:  
M3 16mm 12x

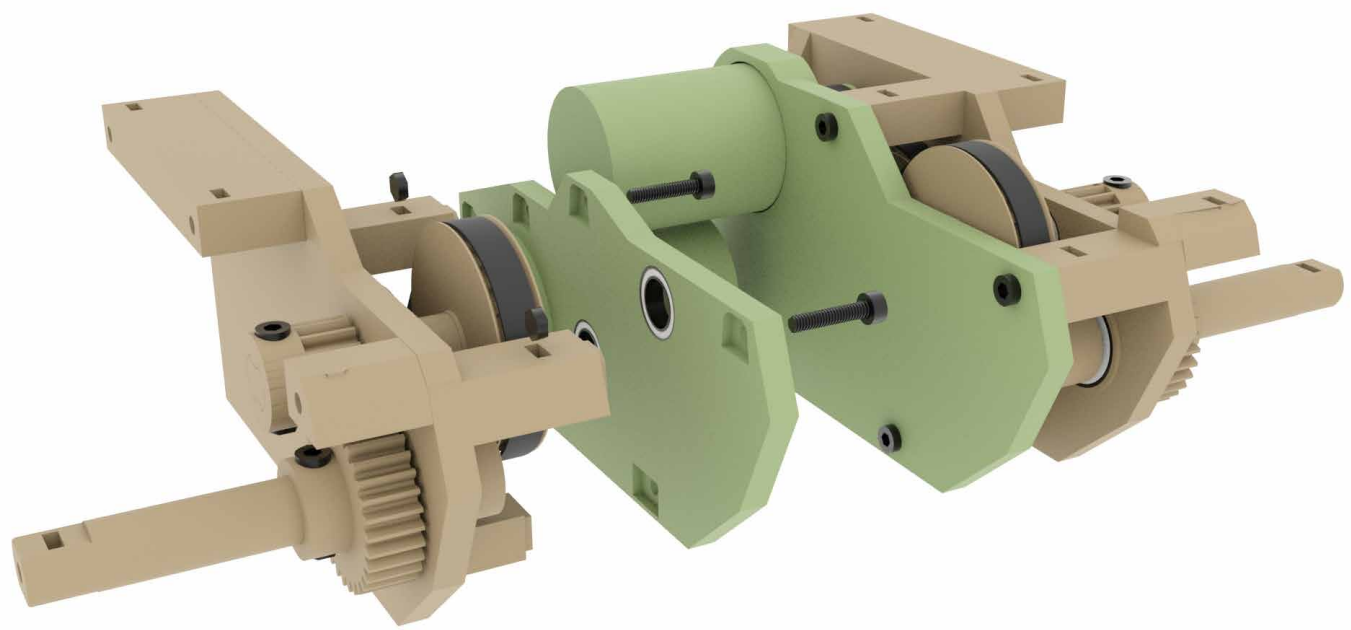

# B



**Soubory:**  
B-1-1x  
B-3-right-5x  
B-3-left-5x

**Soubory:**  
B-2-1x  
B-3-right-5x  
B-3-left-5x  
B-4-right-1x  
B-4-left-1x

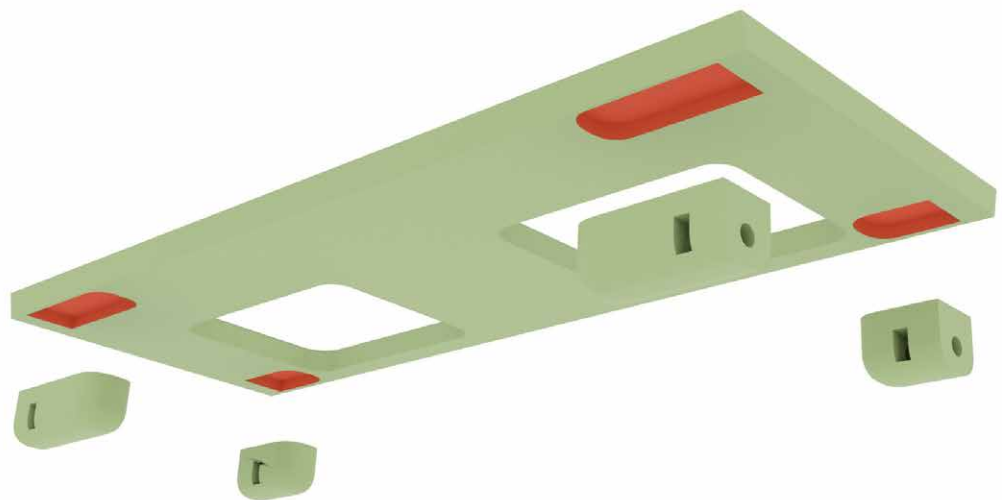

**Soubory:**  
B-1-1x  
B-5-2x  
B-6-2x  
B-7-2x  
B-8-right-1x  
B-8-left-1x

Drát 1mm

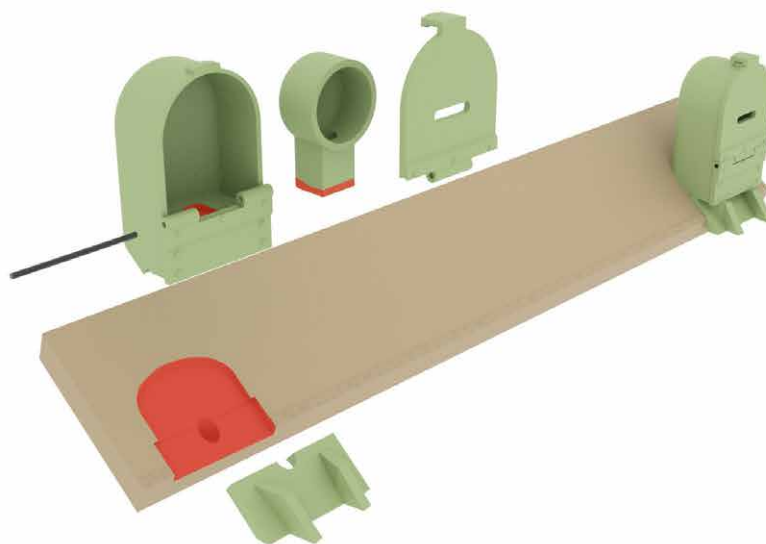

**Soubory:**

B-2-1x  
 B-9-2x  
 B-10-1x  
 B-11-4x  
 B-12-4x  
 B-13-1x  
 B-14-1x  
 B-15-1x  
 B-16-1x

Drát 1mm

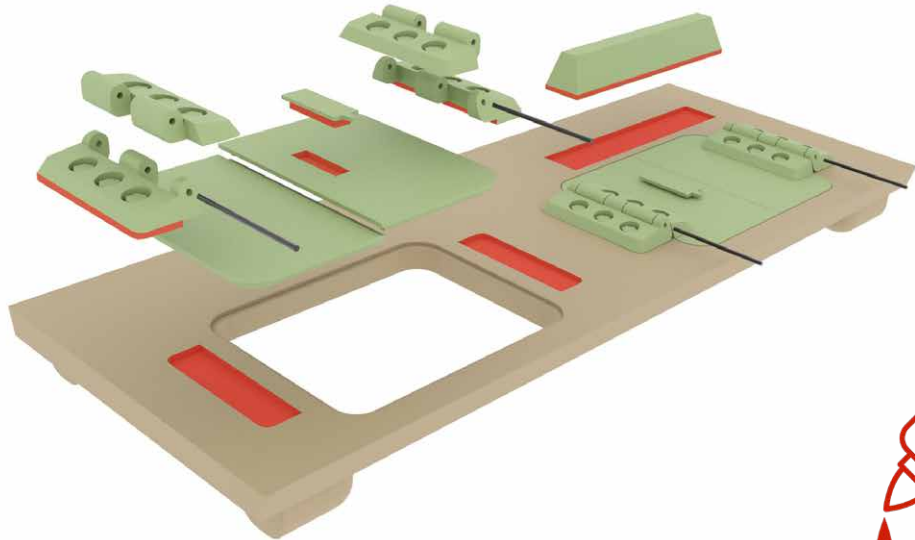
**Soubory:**

B-3-right-5x  
 B-3-left-5x  
 B-17-1x  
 B-18-1x

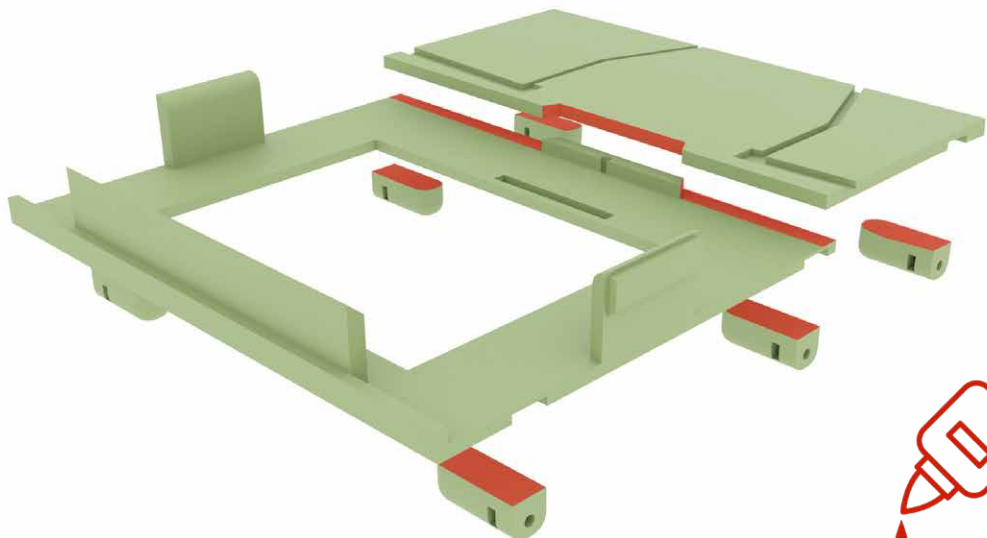
**Soubory:**

B-19-1x  
 B-20-1x  
 B-21-1x

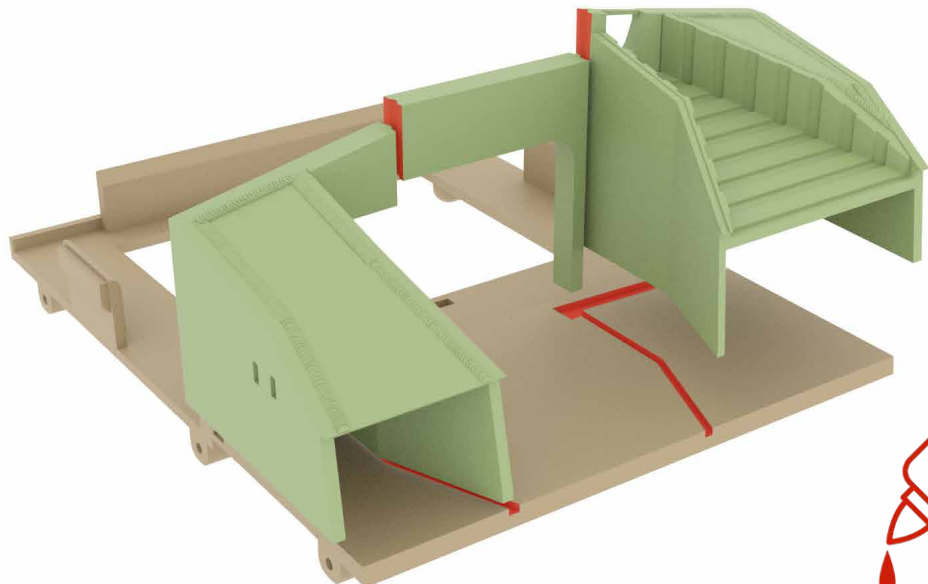

**B**

**Soubory:**  
B-22-right-1x  
B-22-left-1x  
B-23-1x

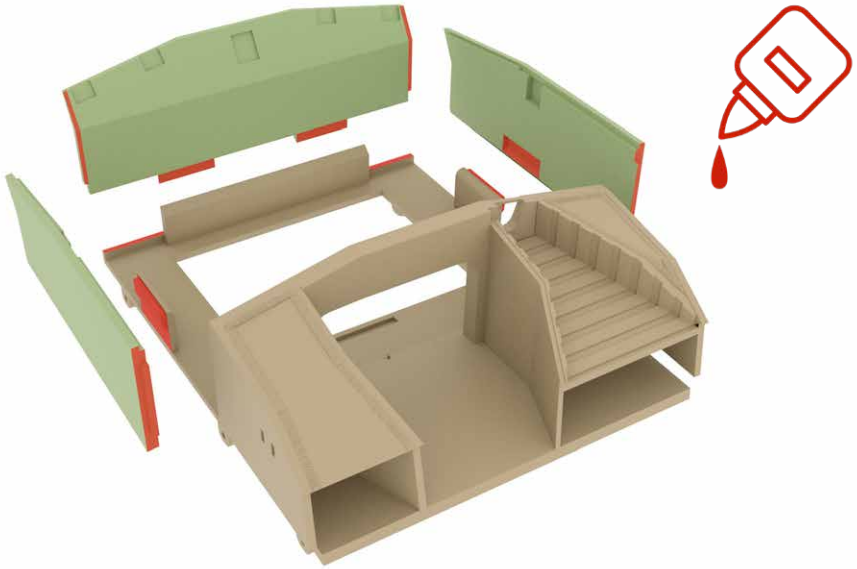

**C**



**Soubory:**  
C-1-1x  
C-2-1x  
C-3-1x

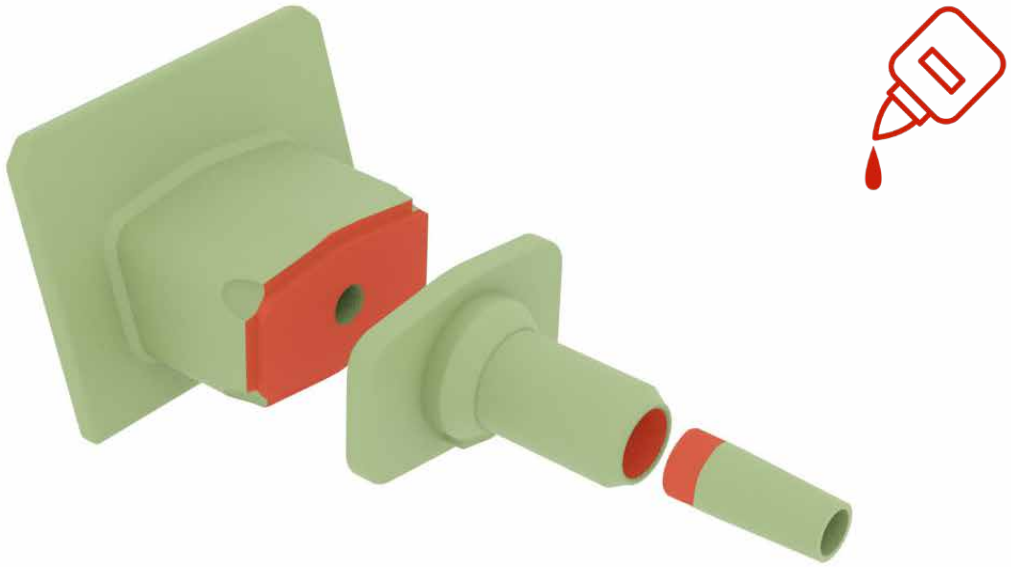



**Soubory:**

C-4-1x  
 C-5-1x  
 -7-1x  
 C-8-2x  
 C-9-1x  
 C-10-1x

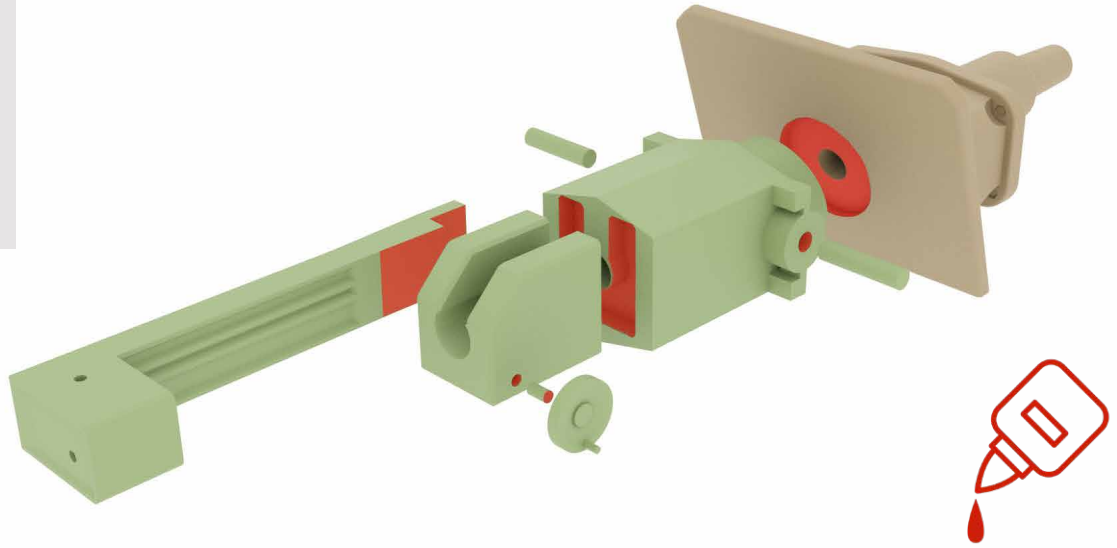
**Soubory:**

C-11-right-1x  
 C-11-left-1x  
 C-12-1x  
 C-13-1x  
 C-14-1x  
 C-15-1x

M3 16mm 1x

B

**Soubory:**

B-24-1x  
 B-25-1x  
 B-26-1x  
 B-27-4x  
 B-28-1x  
 B-29-1x  
 B-30-1x  
 B-31-1x

M3 16mm 4x

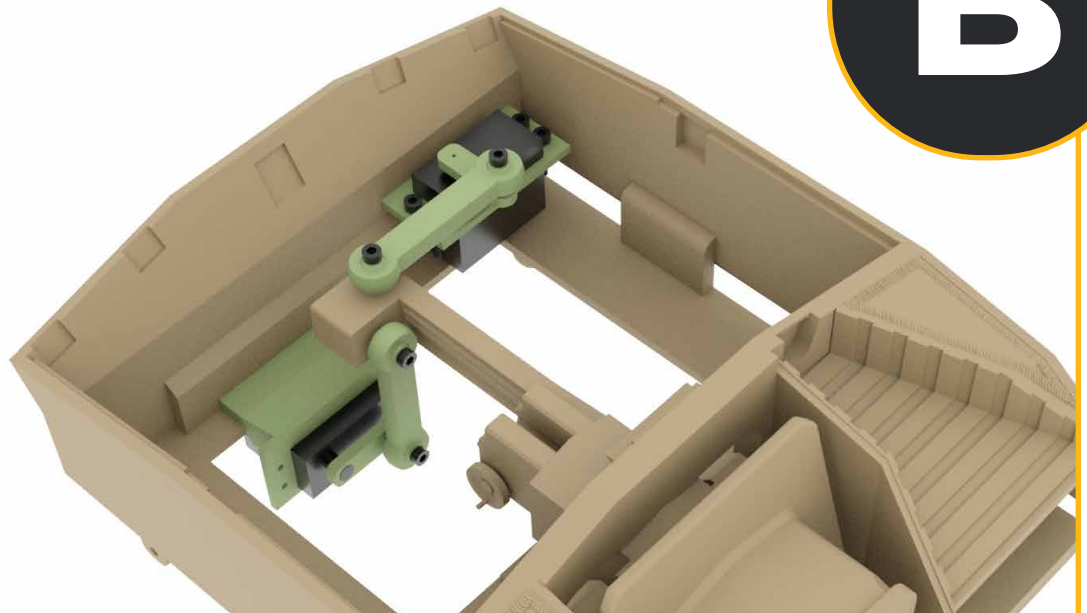

**B**

**Soubory:**

- B-32-4x
- B-33-1x
- B-33-1-1x
- B-34-1x

M3 16mm 5x

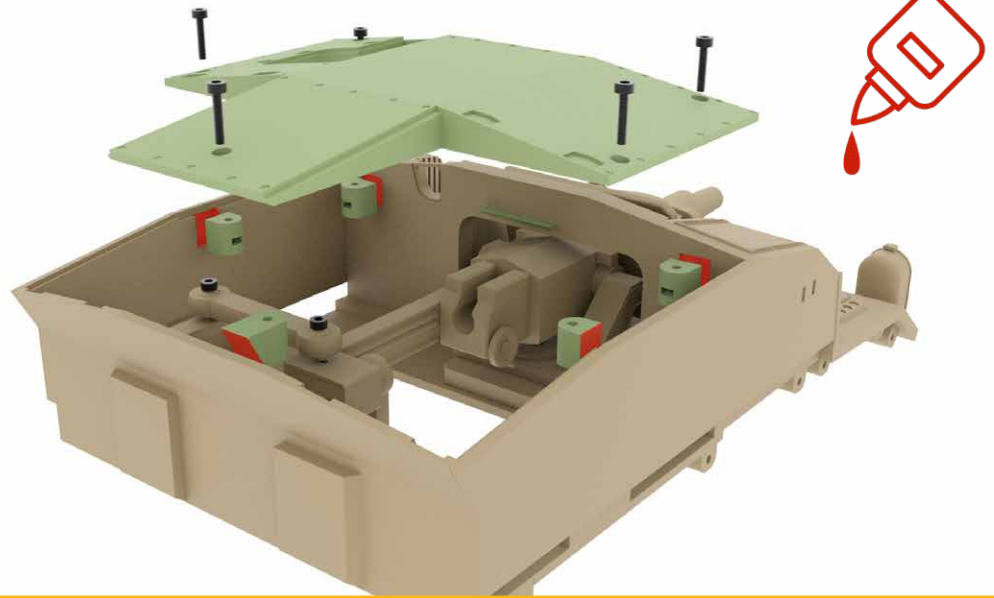

**Soubory:**

- B-35-4x
- B-36-4x
- B-37-3x
- B-38-8x
- B-39-3x
- B-40-left-1x
- B-40-right-1x
- B-41-left-1x
- B-41-right-1x
- B-42-1x
- B-43-1x
- B-44-1x



**Soubory:**

- B-45-1x
- B-46-1x

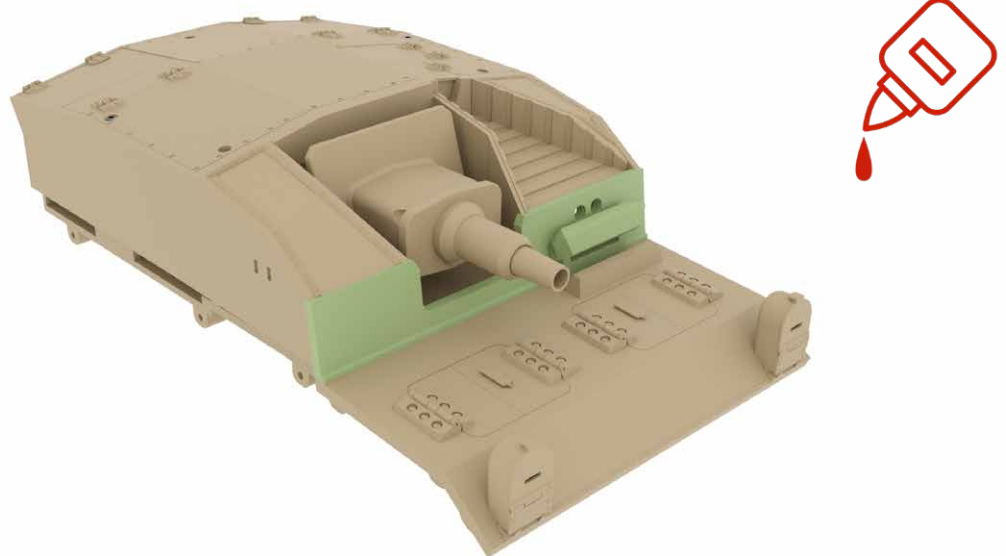

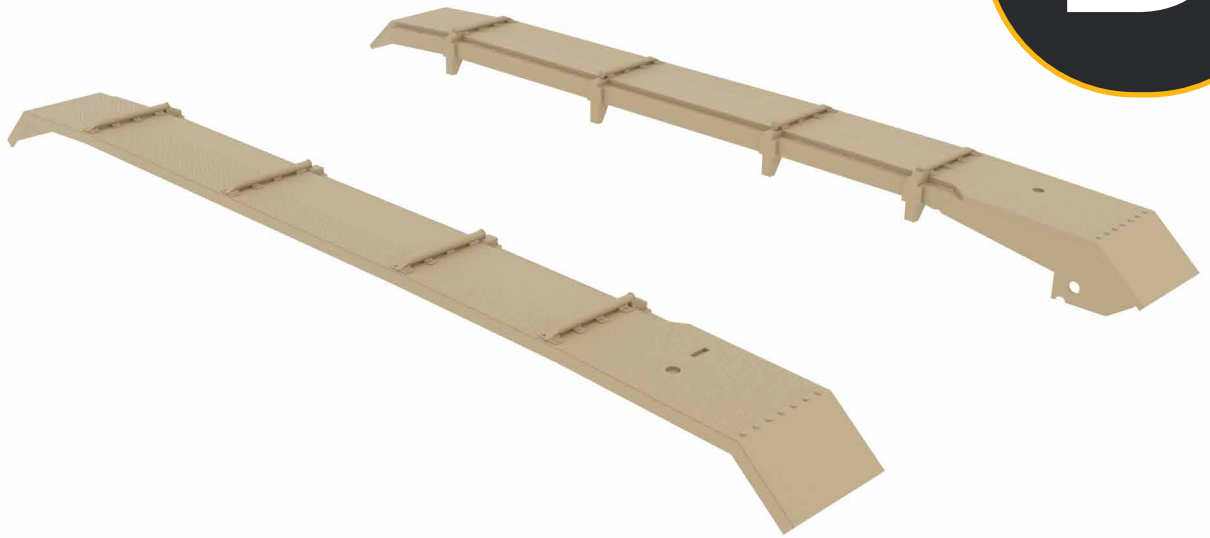

**Soubory:**

- D-1-right-1x
- D-1-left-1x
- D-2-right-1x
- D-2-left-1x
- D-3-right-1x
- D-3-left-1x
- D-4-right-1x
- D-4-left-1x



**Soubory:**

- D-5-right-1x
- D-5-left-1x
- D-6-right-1x
- D-6-left-1x
- D-7-right-1x
- D-7-left-1x
- D-8-right-1x
- D-8-left-1x
- D-9-right-1x
- D-9-left-1x



**Soubory:**

- D-10-right-1x
- D-10-left-1x
- D-11-right-1x
- D-11-left-1x
- D-12-right-1x
- D-12-left-1x



**Soubory:**

- D-13-4x
- D-14-4x

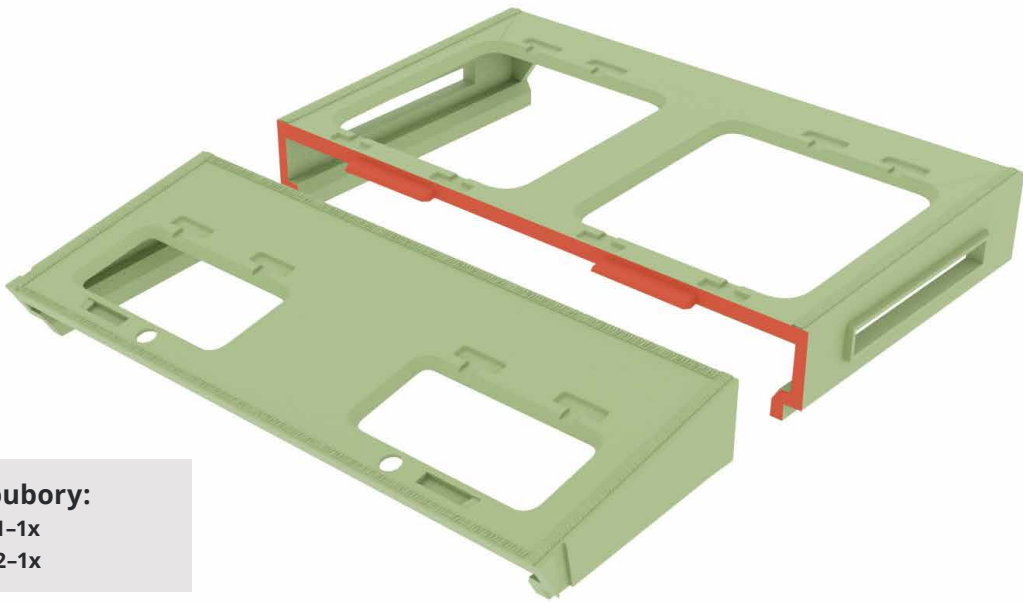

**Soubory:**

E-1-1x  
E-2-1x



**Soubory:**

E-3-2x

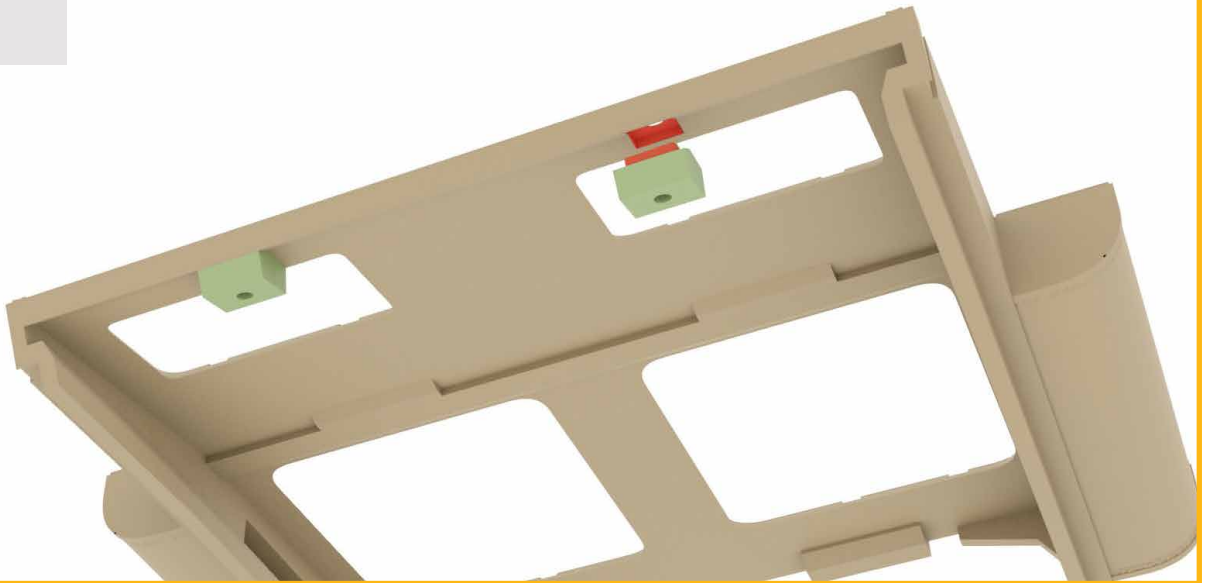

**Soubory:**

E-4-right-1x  
E-4-left-1x  
E-5-right-1x  
E-5-left-1x  
E-6-2x

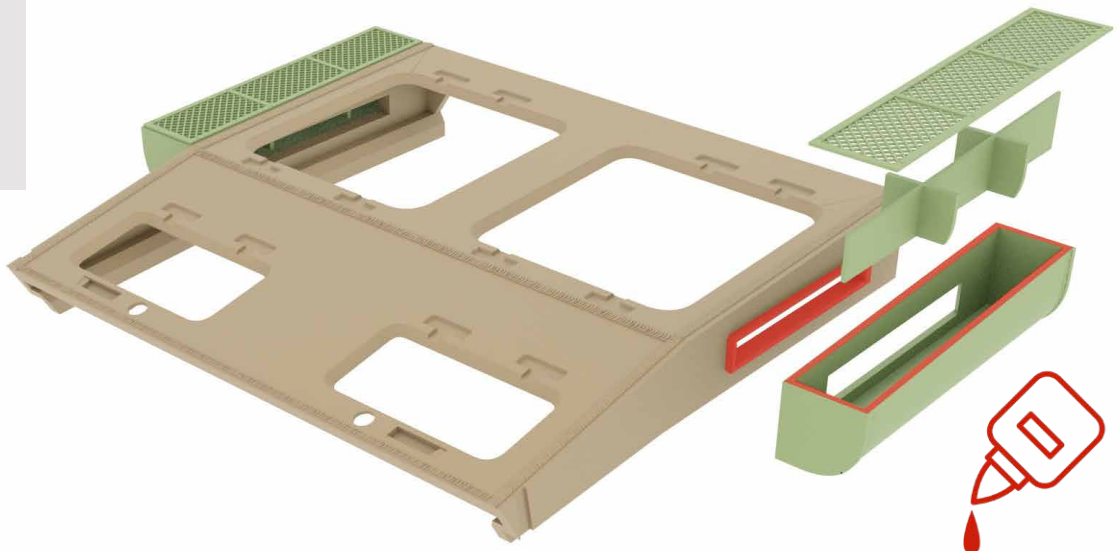

**Soubory:**  
E-7-1-1x  
E-7-2-2x

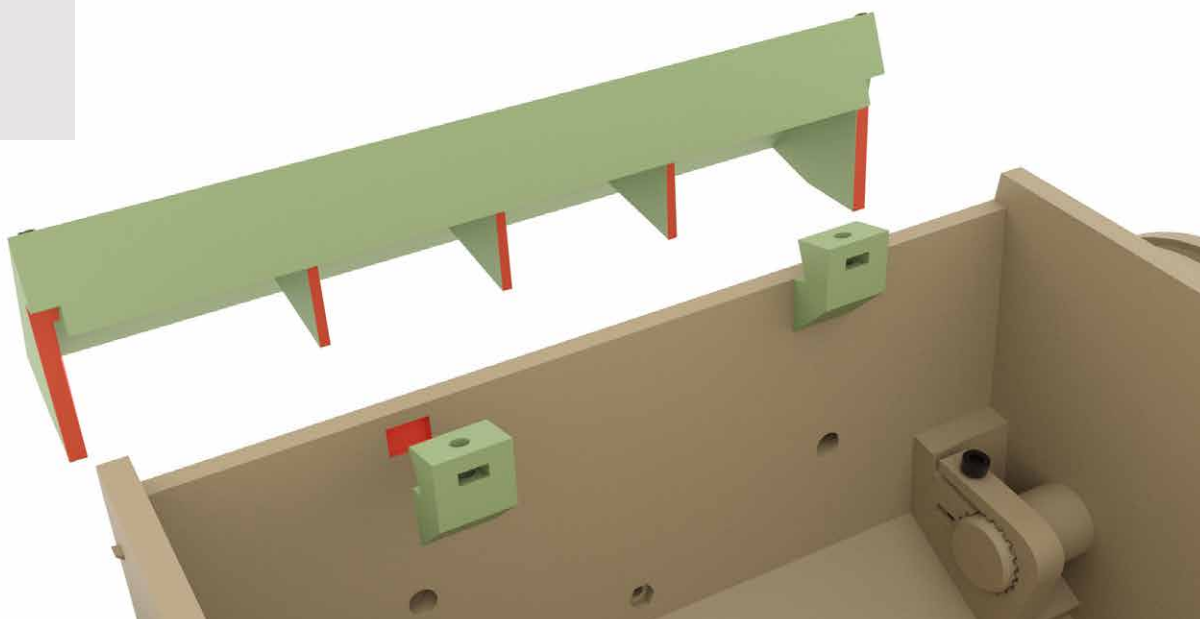

**Soubory:**  
E-8-12x  
E-9-12x  
E-10-2x  
E-11-2x  
E-12-2x

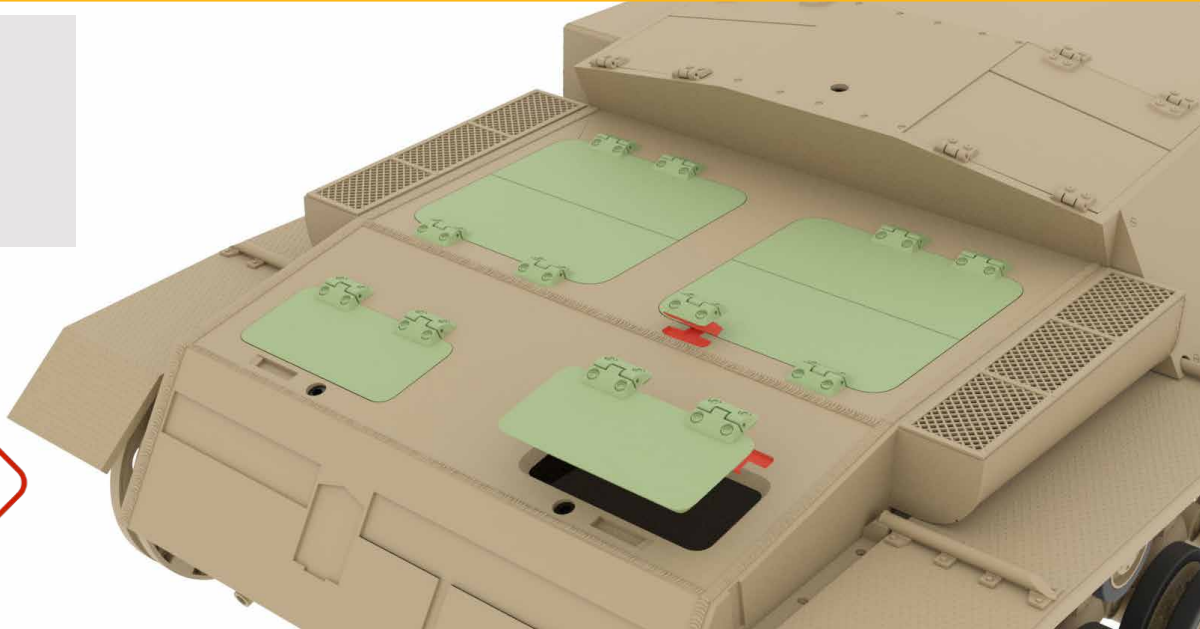

**Soubory:**  
Drát 1mm

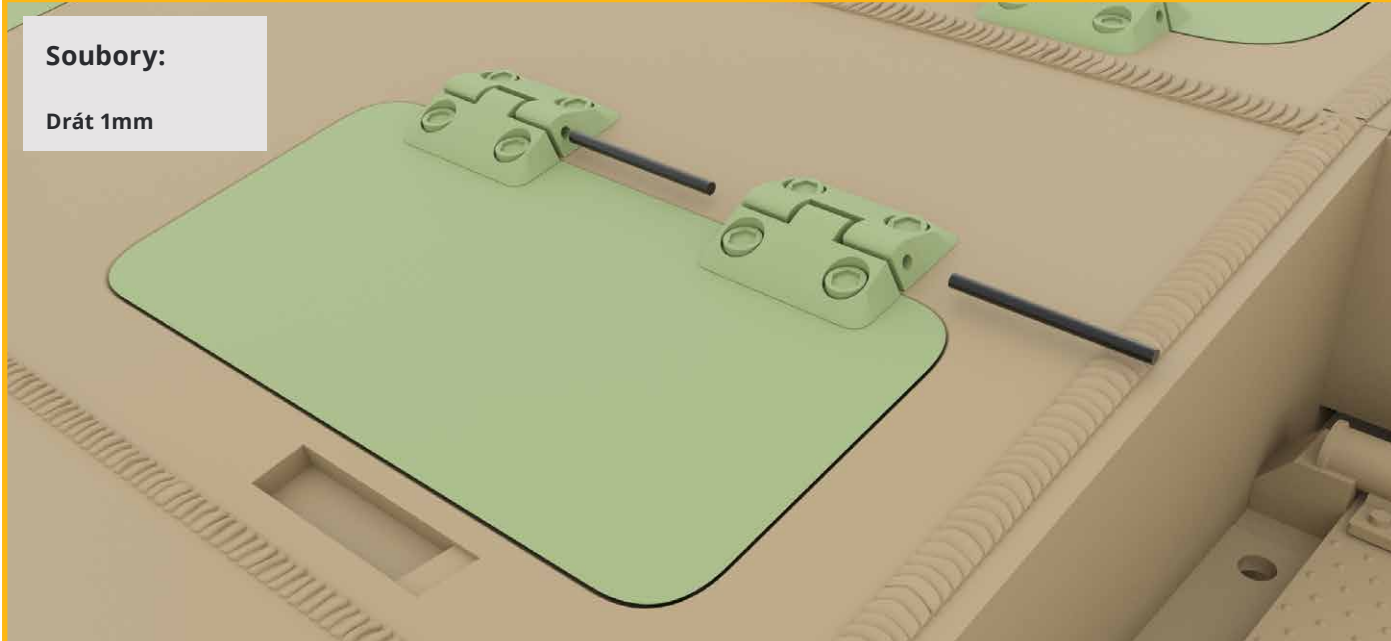

**Soubory:**  
E-13-2x  
E-14-right-1x  
E-14-left-1x  
E-15-right-1x  
E-15-left-1x  
E-16-right-1x  
E-16-left-1x



**Soubory:**  
E-17-1x



**Soubory:**  
E-18-1x  
E-19-1x

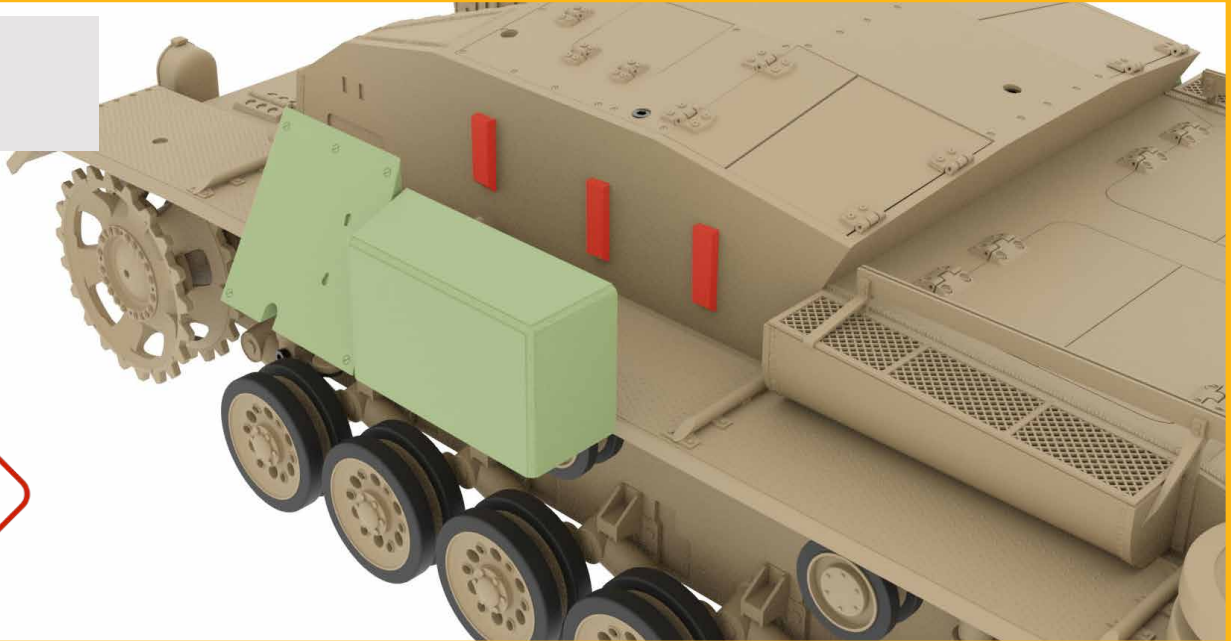

# F

**Soubory:**

- F-1-1x
- F-2-1x
- F-3-1x
- F-4-right-1x
- F-4-left-1x
- F-5-1x
- F-6-1x
- F-7-right-1x
- F-7-left-1x
- F-8-1x
- F-9-2x
- F-10-2x

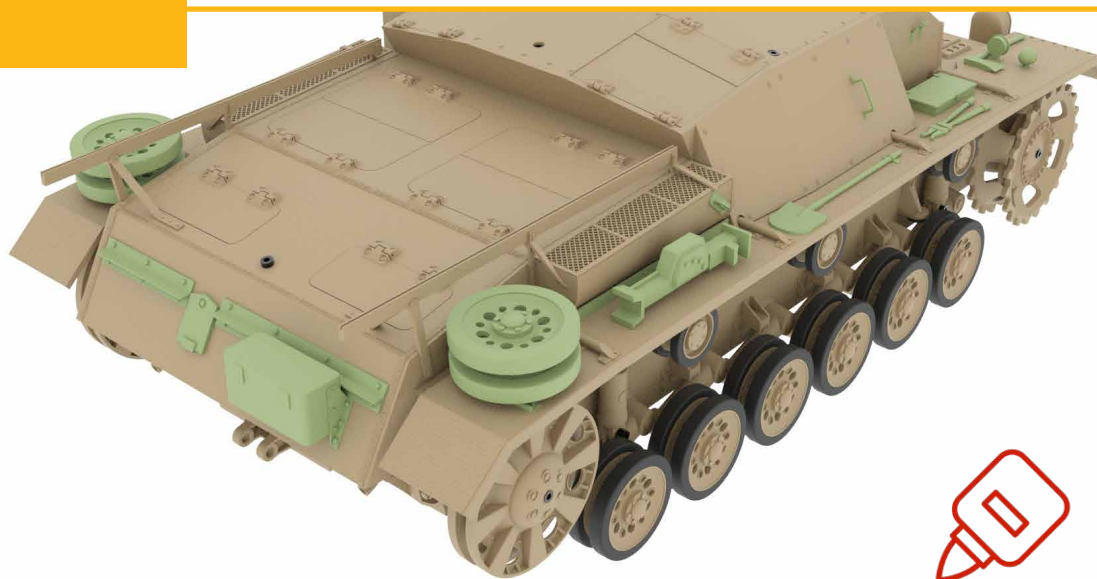

**Soubory:**

- F-11-1x
- F-12-1x
- F-13-1x
- F-14-1x
- F-15-2x
- F-16-2x
- F-17-2x



**Soubory:**

- F-15-2x
- F-16-2x
- F-17-2x
- F-18-1x
- F-19-1x
- F-20-1x
- F-21-1x
- F-22-1x







**Soubory:**  
G-1-188x  
G-2-188x  
G-3-right-94x  
G-3-left-94x







autor: **Petr Školař**  
web: **[www.3dtiks.store](http://www.3dtiks.store)**  
e-mail: **[3dtisk@gpstudio.cz](mailto:3dtisk@gpstudio.cz)**